



2022 Product Catalog





Continuing to inspire for 75 years.

The way we see it, how you serve is just as important as what you're serving. American Metalcraft products elevate food service in every form—restaurants, grocery stores, hotels and catered events alike. To see the difference that incredible presentation can make, look to the little things. Whether we're making barware or buffetware, we find opportunities to incorporate unique details, exceptional functionality and on-trend designs. Our goal is always to make your culinary creations the best possible versions of themselves.

Seventy-five years ago, we broke into the industry by turning hubcaps into deep-dish pizza pans and custom plate covers. We've since grown our product line into an expansive, eclectic collection of food presentation solutions. In these pages, you'll discover creative tabletop accessories, innovative kitchen supplies and every other tool you need to craft an incredible dining experience.

This year we are proud to celebrate our seventy-fifth anniversary being part of this industry that we love. Whether you're a first-time browser or a longtime customer, we hope you find inspiration in our collection. And remember, behind every great meal is great presentation.



Dinnerware 9-40

Tabletop Accessories 41-154

Buffet & Display 155-314

Bar Supplies 315-360

Kitchen Supplies 361-382

Pizza Pans & Supplies 383-437

Symbols



New products that have been added to our catalog in 2022.



Products that are among our top sellers.



Products that are available in retail packaging.



Products that should be hand-washed only.



Products that are economically shipped knocked down. May require assembly.



Products that have received NSF certification and meet strict standards for public health protection.



Products manufactured in the United States of America.



Products made in a North American Free Trade Association member country.



Products that do not contain Bisphenol-A.



WARNING: Products that may contain chemicals known to the state of California to cause cancer, birth defects or other reproductive harm. For more information, go to www.P65Warnings.ca.gov.

Bring something spectacular to the table.

Check out some of our new product highlights.



316
Drinkware

Introducing durable and on-trend Tritan™ drinkware.

40

Noodle Bowls



Serve up today's global fare in our traditional yet contemporary bowls.

124

Mini Melamine Serving Dishes



Let's face it. Cute sells and these mini melamine bowls and plates are the epitome of adorable.

153

Stocked Plate Covers



Top selling plate cover sizes stocked and ready to ship.



Our best-selling dinnerware lines receive notable additions in size and color while brand new collections mix form and functionality to provide modern appeal.

18 The Mix & Matte Collection



10 The Unity Collection





24

The Crave Storm Collection



16

The Coupe Collection



73

Kraft Bags



Innovative bread bags that can be washed and reused.

401

Sicilian-Style Hard Coat Anodized Aluminum Pans



Manufactured of heavy-duty hard coat aluminum, our Sicilian pizza pans are available in all the most popular square and rectangular sizes.

202

The Lift Collection



This buildable collection elevates culinary creations in more ways than one. Now with new shapes and sizes.

Dinnerware





THE UNITY COLLECTION

Finally, a contemporary take on melamine dinnerware that provides the ultimate canvas for today's modern cuisine: The Unity Collection. Named for the intersection of form and function, the Unity Collection combines a clean, straight-sided and stackable design with the durability of melamine. The result is delectably inspiring.

Available in a wide variety of shapes, sizes and capacities, this dual-toned collection features colorways to approach both the coolest and warmest of decors. Intermix the Graphite and Mocha colors together, add a splash of stainless and a touch of Tritan™ and your recipe is complete. The look is truly extraordinary.

THE UNITY COLLECTION

NEW

BPA FREE



Graphite
(GE)



Mocha
(MO)

Please add **GE** for Graphite or **MO** for Mocha to the end of the item number to designate color choice when ordering.



Square Plate
UPS11GE Graphite **UPS11MO** Mocha
 11" Sq. x 1/2" H (27.9 x 1.3 cm)



Square Plate
UPS9GE Graphite **UPS9MO** Mocha
 9" Sq. x 1/2" H (22.9 x 1.3 cm)



Square Plate
UPS6GE Graphite **UPS6MO** Mocha
 6" Sq. x 1/2" H (15.2 x 1.3 cm)



Rectangular Serving Platter
UPLS10GE Graphite **UPLS10MO** Mocha
 10" L x 4 3/4" W x 7/8" H (25.4 x 12.1 x 2.2 cm)



Square Serving Bowl/Tray
UBS60GE Graphite **UBS60MO** Mocha
 60 oz. (1.8 L)
 10" Sq. x 1 1/2" H (25.4 x 3.8 cm)



Square Bowl
UBS16GE Graphite **UBS16MO** Mocha
 16 oz. (473.2 mL)
 4 1/2" Sq. x 2" H (11.4 x 5.1 cm)



Square Bowl
UBS10GE Graphite **UBS10MO** Mocha
 10 oz. (295.7 mL)
 3 5/8" Sq. x 2" H (9.2 x 5.1 cm)



Square Sauce Cup
USCS2GE Graphite **USCS2MO** Mocha
 2 oz. (59.1 mL)
 2" Sq. x 1 5/8" H (5.1 x 4.1 cm)



Round Plate
UPR11GE Graphite **UPR11MO** Mocha
 11" Dia. x 1/2" H (27.9 x 1.3 cm)



Round Plate
UPR9GE Graphite **UPR9MO** Mocha
 9" Dia. x 1/2" H (22.9 x 1.3 cm)



Round Plate
UPR6GE Graphite **UPR6MO** Mocha
 6" Dia. x 1/2" H (15.2 x 1.3 cm)



Oval Serving Platter
UPLR10GE Graphite **UPLR10MO** Mocha
 10 1/2" L x 5 1/4" W x 7/8" H (26.7 x 13.3 x 2.2 cm)



Round Serving Bowl/Tray
UBR48GE Graphite **UBR48MO** Mocha
 48 oz. (1.4 L)
 10" Dia. x 1 1/2" H (25.4 x 3.8 cm)



Round Bowl
UBR32GE Graphite **UBR32MO** Mocha
 32 oz. (946.4 mL)
 6 1/4" Dia. x 2 1/2" H (15.9 x 6.4 cm)



Round Bowl
UBR24GE Graphite **UBR24MO** Mocha
 24 oz. (709.8 mL)
 5 3/4" Dia. x 2 1/4" H (14.6 x 5.7 cm)



Round Bowl
UBR16GE Graphite **UBR16MO** Mocha
 16 oz. (473.2 mL)
 5 1/8" Dia. x 2" H (13 x 5.1 cm)



Round Bowl
UBR10GE Graphite **UBR10MO** Mocha
 10 oz. (295.7 mL)
 4 1/4" Dia. x 2" H (10.8 x 5.1 cm)



Round Bowl
UBR5GE Graphite **UBR5MO** Mocha
 5 oz. (147.9 mL)
 3 3/8" Dia. x 1 5/8" H (9.2 x 4.1 cm)



Round Sauce Cup
USCR2GE Graphite **USCR2MO** Mocha
 2 oz. (59.1 mL)
 2 1/2" Dia. x 1 3/8" H (6.4 x 4.1 cm)



Stackable Mug
UM12GE Graphite **UM12MO** Mocha
 12 oz. (354.9 mL)
 3 1/8" Dia. x 4 1/8" H (7.9 x 10.5 cm)



NEW

SMP4

SMP6

SMB3

Top to bottom:
SMP9
SMP11



NEW

Top to bottom:
SMP4
SMP6
SMP9
SMP11

THE UNITY COLLECTION NEW

Who says that flatware should be the only touch of silver at a place setting? The Unity Collection's satin-finished stainless steel plates and bowls not only bring together form and function at the table, but they unite different materials in a beautiful marriage of modern sophistication. Use as the star of the show or as a beautiful accessory, each piece is beautifully designed to add a bit of sparkle to your meal.



Plate
SMP11 Satin Finish
 11" Dia. x 1/2" H (27.9 x 1.3 cm)



Plate
SMP9 Satin Finish
 9" Dia. x 1/2" H (22.8 x 1.3 cm)



Plate
SMP6 Satin Finish
 6" Dia. x 1/2" H (15.2 x 1.3 cm)



Plate
SMP4 Satin Finish
 4" Dia. x 1/2" H (10.2 x 1.3 cm)



Bowl/Tray
SMB10 Satin Finish
 60 oz. (1.8 mL)
 10" Dia. x 1 1/2" H (25.4 x 3.8 cm)



Bowl
SMB6 Satin Finish
 29 oz. (857.6 mL)
 6" Dia. x 2" H (15.2 x 5.1 cm)



Bowl
SMB5 Satin Finish
 15 oz. (443.6 mL)
 5" Dia. x 1 1/4" H (12.7 x 3.2 cm)



Bowl
SMB4 Satin Finish
 8 oz. (236.6 mL)
 4" Dia. x 1 1/4" H (10.2 x 3.2 cm)



Bowl
SMB3 Satin Finish
 4 oz. (118.3 mL)
 3" Dia. x 1" H (7.6 x 2.5 cm)



THE COUPE COLLECTION NEW

Elegant yet simple, the Coupe Collection offers a level of subtle refinement to the tabletop. Available in a wide array of popular sizes, this satin-finished line of stainless steel dinnerware is a versatile (yet durable) suggestion in modern dinnerware. Use as a charger, a dinner plate, a tray, a coaster - the options are endless.



Coupe Plate
SSP13 Satin Finish
13" Dia. x $\frac{3}{8}$ " H (33 x 1 cm)



Coupe Plate
SSP12 Satin Finish
12" Dia. x $\frac{3}{8}$ " H (30.5 x 1 cm)



Coupe Plate
SSP10 Satin Finish
10 $\frac{1}{2}$ " Dia. x $\frac{3}{8}$ " H (26.7 x 1 cm)



Coupe Plate
SSP9 Satin Finish
9" Dia. x $\frac{3}{8}$ " H (22.9 x 1 cm)



Coupe Plate
SSP8 Satin Finish
8" Dia. x $\frac{3}{8}$ " H (20.3 x 1 cm)



Coupe Plate
SSP6 Satin Finish
6" Dia. x $\frac{3}{8}$ " H (15.2 x 1 cm)



Coupe Plate
SSP4 Satin Finish
4" Dia. x $\frac{3}{8}$ " H (10.2 x 1 cm)



THE MIX & MATTE COLLECTION



When laid-back presentation won't cut it, our Mix & Matte Collection of melamine dinnerware lends an air of luxury. Designed to be mixed and matched (hence the name), these matte pieces can stand up to even the noblest menu items.



White
(WH)



Marble
(MA)



Gray
(GR)



Gray Marble
(GM)

Please add **WH** for White, **MA** for Marble, **GR** for Gray or **GM** for Gray Marble to the end of the item number to designate color choice when ordering.



Coupe Plate
MCP11WH White **MCP11MA** Marble
MCP11GR Gray **MCP11GM** Gray Marble
 11 ½" Dia. x 1" H (29.2 x 2.5 cm)



Coupe Plate
MCP9WH White **MCP9MA** Marble
MCP9GR Gray **MCP9GM** Gray Marble
 9" Dia. x 1" H (22.9 x 2.5 cm)



NEW

Coupe Plate
MCP6WH White **MCP6MA** Marble
MCP6GR Gray **MCP6GM** Gray Marble
 6" Dia. x ⅝" H (15.2 x 1.6 cm)



Rectangular Platter
MCP12WH White **MCP12MA** Marble
MCP12GR Gray **MCP12GM** Gray Marble
 12" L x 7" W x 1" H (30.5 x 17.8 x 2.5 cm)



Coupe Bowl
MCB36WH White **MCB36MA** Marble
MCB36GR Gray **MCB36GM** Gray Marble
 36 oz. (1.1 L)
 8 ¾" Dia. x 2" H (22.2 x 5.1 cm)



NEW

Coupe Bowl
MCB12WH White **MCB12MA** Marble
MCB12GR Gray **MCB12GM** Gray Marble
 12 oz. (354.9 mL)
 6" Dia. x 1 ½" H (15.2 x 3.8 cm)



Bouillon Cup
MCB10WH White **MCB10MA** Marble
MCB10GR Gray **MCB10GM** Gray Marble
 10 oz. (295.7 mL)
 4 ½" Dia. x 2 ¼" H (11.4 x 5.7 cm)



THE CRAVE COLLECTION

Our Crave Collection of break-resistant melamine dinnerware is back and bigger than ever. In a wide variety of plates, platters, bowls and mugs, this is not your grandma's melamine. Fast forward, rather, to the 21st century, where technological advancements in designs, materials and manufacturing techniques create artisan-quality melamine that captures the look and feel of china—all at a fraction of the cost and two to three times the service life.

NSF-certified and BPA-free, the Crave Collection is safe in terms of durability, design and ability to be thoroughly sanitized. In two base colors and new additional color options, each artisanally designed piece features organic edges to elevate food service everywhere.



CBL16CL, CP7SH, CP10CL
shown with MSR14 serving board

THE CRAVE COLLECTION



Cloud
(CL)



Shadow
(SH)

Please add **CL** for Cloud or **SH** for Shadow to the end of the item number to designate color choice when ordering.



Coupe Plate
CP10CL Cloud CP10SH Shadow
11 1/8" Dia. x 3/4" H (28.3 x 1.9 cm)



Coupe Plate
CP9CL Cloud CP9SH Shadow
9" Dia. x 1" H (22.9 x 2.5 cm)



Coupe Plate
CP7CL Cloud CP7SH Shadow
7 1/2" Dia. x 7/8" H (19.1 x 2.2 cm)



Coupe B&B Plate
CP6CL Cloud CP6SH Shadow
6 1/2" Dia. x 3/4" H (16.5 x 1.9 cm)



Rectangular Platter
CP12CL Cloud CP12SH Shadow
12" L x 7 1/8" W x 1" H (30.5 x 18.1 x 2.5 cm)



Oval Serving Platter
CPL12CL Cloud CPL12SH Shadow
12" L x 9" W x 7/8" H (30.5 x 22.9 x 2.2 cm)



Serving Bowl
CBL95CL Cloud CBL95SH Shadow
95 oz. (2.8 L)
13 1/2" Dia. x 2 1/4" H (34.3 x 5.7 cm)



Coupe Bowl
CBL20CL Cloud CBL20SH Shadow
20 oz. (591.5 mL)
9" Dia. x 1 1/2" H (22.9 x 3.8 cm)



Coupe Bowl
CBP16CL Cloud CBP16SH Shadow
16 oz. (473.2 mL)
8 1/2" Dia. x 1 1/2" H (21.6 x 3.8 cm)



Coupe Bowl
CBL13CL Cloud CBL13SH Shadow
13 oz. (384.5 mL) 7" Dia. x 1 1/2" H (17.8 x 3.8 cm)



Coupe Bowl
CBL8CL Cloud CBL8SH Shadow
8 oz. (236.6 mL) 6" Dia. x 1 1/4" H (15.2 x 3.2 cm)



Noodle Bowl
CBL50CL Cloud **CBL50SH** Shadow
 50 oz. (1.5 L)
 7 1/2" Dia. x 4 3/4" H (19.1 x 12.1 cm)



Noodle Bowl
CBL40CL Cloud **CBL40SH** Shadow
 40 oz. (1.2 L)
 7 1/8" Dia. x 4 1/4" H (18.1 x 10.8 cm)



Bowl
CBL32CL Cloud **CBL32SH** Shadow
 32 oz. (946.4 mL)
 7 1/8" Dia. x 2 1/2" H (18.1 x 6.4 cm)



Bowl
CBL24CL Cloud **CBL24SH** Shadow
 24 oz. (709.8 mL)
 6 1/2" Dia. x 2 1/4" H (16.5 x 5.7 cm)



Soup/Salad Bowl
CBL16CL Cloud **CBL16SH** Shadow
 16 oz. (473.2 mL)
 5 3/4" Dia. x 2" H (14.6 x 5.1 cm)



Nappy Bowl
CBL12CL Cloud **CBL12SH** Shadow
 12 oz. (354.9 mL)
 5 3/4" Dia. x 2" H (14.6 x 5.1 cm)



Bouillon Cup
CBC10CL Cloud **CBC10SH** Shadow
 10 oz. (295.7 mL)
 4 1/2" Dia. x 2 1/8" H (11.4 x 5.4 cm)



Bouillon Cup
CBC7CL Cloud **CBC7SH** Shadow
 7 oz. (207 mL)
 4" Dia. x 2" H (10.2 x 5.1 cm)



Fruit Bowl
CBL4CL Cloud **CBL4SH** Shadow
 4 1/2 oz. (133.1 mL)
 4" Dia. x 1 1/2" H (10.2 x 3.8 cm)



Sauce Cup
CSC4CL Cloud **CSC4SH** Shadow
 4 1/2 oz. (133.1 mL)
 3 1/4" Dia. x 2" H (8.3 x 5.1 cm)



Stackable Mug
CM12CL Cloud **CM12SH** Shadow
 12 oz. (354.9 mL)
 3 3/8" Dia. x 3 5/8" H (8.6 x 9.2 cm)



CP12ST

Top to bottom:
CP9ST
CP10ST

THE CRAVE STORM COLLECTION **NSF** **BPA FREE**

Our Crave Collection of break-resistant melamine dinnerware is back and bigger than ever with a new bold color: Storm. NSF-Certified and BPA-free, this collection is safe in terms of durability, design and ability to be thoroughly sanitized.

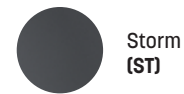

Storm
(ST)

Please add **ST** for Storm to the end of the item number to designate color choice when ordering.



Coupe Plate
CP10ST Storm
11 1/8" Dia. x 3/4" H (28.3 x 1.9 cm)



Coupe Plate
CP9ST Storm
9" Dia. x 1" H (22.9 x 2.5 cm)



NEW

Coupe Plate
CP7ST Storm
7 1/2" Dia. x 7/8" H (19.1 x 2.2 cm)



NEW

Coupe Plate
CP6ST Storm
6 1/2" Dia. x 3/4" H (16.5 x 1.9 cm)



Rectangular Platter
CP12ST Storm
12" L x 7 1/8" W x 1" H (30.5 x 18.1 x 2.5 cm)



NEW

Bowl
CBL20ST Storm
20 oz. (591.5 mL)
9" Dia. x 1 1/2" H (22.9 x 3.8 cm)



Soup/Salad Bowl
CBL16ST Storm
16 oz. (473.2 mL)
5 3/4" Dia. x 2" H (14.6 x 5.1 cm)



NEW

Nappy Bowl
CBL12ST Storm
12 oz. (354.9 mL)
6" Dia. x 2" H (15.2 x 5.1 cm)



Bouillon Cup
CBC10ST Storm
10 oz. (295.7 mL)
4 1/2" Dia. x 2 1/8" H (11.4 x 5.4 cm)



NEW

Bouillon Cup
CBC7ST Storm
7 oz. (207 mL)
4" Dia. x 2" H (10.2 x 5.1 cm)



NEW

Sauce Cup
CSC4ST Storm
4 1/2 oz. (133.1 mL)
3 1/4" Dia. x 2" H (8.3 x 5.1 cm)



NEW

Stackable Mug
CM12ST Storm
12 oz. (354.9 mL)
3 3/8" Dia. x 3 5/8" H (8.6 x 9.2 cm)



MIX AND MATCH CRAVE COLORS FOR A DIMENSIONAL LOOK



CBC10DU

Top to bottom: CBL16DU, CP9SA, CP10DU

CP12DU

SAGE AND DUSK FEATURE A TRENDY SPECKLE DESIGN

THE CRAVE COLOR COLLECTION



SAGE
(SA)



DUSK
(DU)

We gave our durable Crave Collection a pop of color, and these beauties are the result. In spirited Sage and dreamy Dusk, the Crave Color Collection features dependable melamine construction and a vibrant speckled appearance that your diners will love.

Please add **SA** for Sage or **DU** for Dusk to the end of the item number to designate color choice when ordering.



Coupe Plate
CP10SA Sage **CP10DU** Dusk
 11 1/8" Dia. x 3/4" H
 (28.3 x 1.9 cm)



Coupe Plate
CP9SA Sage **CP9DU** Dusk
 9" Dia. x 1" H
 (22.9 x 2.5 cm)



Soup/Salad Bowl
CBL16SA Sage **CBL16DU** Dusk
 16 oz. (473.2 mL)
 5 3/4" Dia. x 2" H (14.6 x 5.1 cm)



Bouillon Cup
CBC10SA Sage **CBC10DU** Dusk
 10 oz. (295.7 mL)
 4 1/2" Dia. x 2 1/8" H (11.4 x 5.4 cm)



Rectangular Platter
CP12SA Sage **CP12DU** Dusk
 12" L x 7 1/8" W x 1" H
 (30.5 x 18.1 x 2.5 cm)



THE JANE COLLECTION

Dinnerware has a new standard. The Jane Collection, our “basic” dinnerware line, is anything but ordinary. Simple and versatile by design, these plates, bowls, cups, platters and even sauce cups serve as ideal backdrops for all types of menu items. From low-key lunches to gastronomically-inspired dinners, the possibilities are practically endless.

We chose to craft the Jane Collection from melamine for two reasons: First, it's exceptionally resilient to the bumps, bangs and bounces that find their way into every kitchen. This dinnerware is in it for the long haul. Second, melamine is dishwasher-safe. No matter how you're inspired to fill these blank canvases, cleaning and reusing them is a cinch.



THE JANE COLLECTION



Wide Rim Plate
DPW10WH White
 10 ½" Dia. x ¾" H (26.7 x 1.9 cm)



Wide Rim Plate
DPW9WH White
 9" Dia. x ¾" H (22.9 x 1.9 cm)



Wide Rim Plate
DPW7WH White
 7 ½" Dia. x ¾" H (19.1 x 1.6 cm)



Wide Rim B&B Plate
DPW6WH White
 6 ½" Dia. x ⅝" H (16.5 x 1.6 cm)



Narrow Rim Plate
DPN10WH White
 10 ½" Dia. x ¾" H (26.7 x 1.9 cm)



Narrow Rim Plate
DPN9WH White
 9" Dia. x ¾" H (22.9 x 1.9 cm)



Narrow Rim Plate
DPN7WH White
 7 ½" Dia. x ⅝" H (19.1 x 1.6 cm)



Narrow Rim B&B Plate
DPN6WH White
 6 ½" Dia. x ⅝" H (16.5 x 1.6 cm)



Saucer
DS5WH White
 5 ½" Dia. x ⅝" H (14 x 1.6 cm)



Oval Platter
DPL12WH White
 12" L x 9" W x 7/8" H (30.5 x 22.9 x 2.2 cm)



Oval Platter
DPL9WH White
 9 ¾" L x 7 ¼" W x ½" H (24.8 x 18.4 x 1.3 cm)



Stackable Mug
DM10WH White
 10 oz. (295.7 mL)
 3" Dia. x 3 ⅝" H (7.6 x 9.2 cm)



Wide Rim Bowl
DBW16WH White
 16 oz. (473.2 mL)
 9 1/4" Dia. x 1 1/4" H (23.5 x 3.2 cm)



NEW

Narrow Rim Bowl
DBN32WH White
 32 oz. (946.4 mL)
 8 1/2" Dia. x 2 3/8" H (21.6 x 6 cm)



NEW

Narrow Rim Bowl
DBN24WH White
 24 oz. (709.8 mL)
 7 3/4" Dia. x 2 1/8" H (19.7 x 5.4 cm)



Narrow Rim Bowl
DBN16WH White
 16 oz. (473.2 mL)
 7 1/4" Dia. x 1 7/8" H (18.4 x 4.8 cm)



NEW

Bowl
DB12WH White
 12 oz. (354.9 mL)
 6 5/8" Dia. x 1 1/2" H (16.8 x 3.8 cm)



Bowl
DB8WH White
 8 oz. (236.6 mL)
 6" Dia. x 1 3/8" H (15.2 x 3.5 cm)



Fruit Bowl
DB5WH White
 5 oz. (147.9 mL)
 5" Dia. x 1 3/8" H (12.7 x 3.5 cm)



Bouillon Cup
DB10WH White
 10 oz. (295.7 mL)
 4 1/2" Dia. x 2 1/4" H (11.4 x 5.7 cm)



Bouillon Cup
DB7WH White
 7 oz. (207 mL)
 4" Dia. x 2 1/8" H (10.2 x 5.4 cm)



Sauce Cup
MSC8 White
 8 oz. (236.6 mL)
 3 5/8" Dia. x 2 1/8" H (9.2 x 5.4 cm)



Sauce Cup
DSC3WH White
 2 3/4 oz. (81.3 mL)
 3 1/2" Dia. x 1" H (8.9 x 2.5 cm)



Sauce Cup
DSC1WH White
 1 oz. (29.6 mL)
 2 3/4" Dia. x 7/8" H (7 x 2.2 cm)

THE JANE CASUAL COLLECTION

NSF

BPA FREE



LINEN
(LN)



DENIM
(DN)

The Jane Casual Collection pairs the simple styling of the Jane Collection with fun, friendly finishes inspired by linen and denim. Crafted from durable melamine, these plates, bowls and serving platters let you turn any meal into comfort food.

Please add **LN** for Linen or **DN** for Denim to the end of the item number to designate color choice when ordering.



Narrow Rim Plate
DPN10LN Linen **DPN10DN** Denim
 10 1/2" Dia. x 3/4" H
 (26.7 x 1.9 cm)



Narrow Rim Plate
DPN9LN Linen **DPN9DN** Denim
 9" Dia. x 3/4" H
 (22.9 x 1.9 cm)



Narrow Rim Bowl
DBN16LN Linen **DBN16DN** Denim
 16 oz. (473.2 mL)
 7 1/4" Dia. x 1 7/8" H (18.4 x 4.8 cm)



Bouillon Cup
DB10LN Linen **DB10DN** Denim
 10 oz. (295.7 mL)
 4 1/2" Dia. x 2 1/4" H (11.4 x 5.7 cm)



Oval Platter
DPL12LN Linen **DPL12DN** Denim
 12" L x 9" W x 7/8" H
 (30.5 x 22.9 x 2.2 cm)

RESILIENT MELAMINE MEANS THE ISABELLA COLLECTION IMPRESSES IN AL FRESCO SETTINGS TOO



BLUP5

BLUP14

From smallest
to largest:
BLUP6
BLUP8
BLUP11

THE ISABELLA COLLECTION

NSF

BPA
FREE

Inspired by classic china, these timelessly nostalgic pieces feature beautiful floral designs that could pass as individually made. Whether you use them to serve entrées, hors d'oeuvres or desserts, your customers just might be transported to a Florentine patio when this collection reaches the table. Because the Isabella Collection is crafted from BPA-free, NSF-approved melamine, you can create elegant presentations day after day and night after night without concerns of safety or durability.



Plate
BLUP11
11" Dia. x 1" H
(27.9 x 2.5 cm)



Scalloped Plate
BLUP8
8 ¾" Dia. x 1" H
(22.2 x 2.5 cm)



Plate
BLUP6
6 ½" Dia. x ¾" H
(16.5 x 1.6 cm)



Coupe Bowl
BLUP5
6 oz. (177.4 mL)
5" Dia. x 1" H
(12.7 x 2.5 cm)



Rectangular Platter
BLUP14
14" L x 5 ⅝" W x 1 ¼" H
(35.6 x 14.3 x 3.2 cm)



NRV12 shown with DPW7WH and DPW10WH wide rim plates



Shown with DPN10WH narrow rim plate and SSP2 S&P set

NRS12

Napkin Rings

In galvanized steel, stainless steel and aluminum, our first-ever line of napkin rings features the quality and attention to detail that you've come to expect from American Metalcraft. **Sold in a pack of 12.**

NRV12 Galvanized Steel
 2" Dia. x 2" H
 (5.1 x 5.1 cm)

NRS12 Stainless Steel
 1 5/8" Sq. x 1 1/4" H
 (4.1 x 3.2 cm)

NRA12 Hammered Aluminum
 1 1/2" Dia. x 1 3/4" H
 (3.8 x 4.4 cm)



NRA12

Shown with DPW10WH wide rim plate and BVJGG4 bud vase



Melamine Paper Plates BPA FREE

Much more durable than its cardboard counterparts, pure white melamine pieces are whimsically designed like paper plates, but dress up events with their look and feel.

- MP6** 5 7/8" Dia. x 5/8" H
(14.9 x 1.6 cm)
- MP7** 7 3/8" Dia. x 5/8" H
(18.7 x 1.6 cm)
- MP9** 8 7/8" Dia. x 5/8" H
(22.5 x 1.6 cm)
- MP11** 10 7/8" Dia. x 3/4" H
(27.6 x 1.9 cm)

Naturals Collection

Bento Boxes NEW BPA FREE

Meal delivery has received a beautiful makeover with the Naturals Collection Bento Box. Sleek and stylish with a hint of marble, each box is durable and stackable with matching lids. Choose from boxes with or without compartments for added versatility.

- BB5WH** 5-Compartment White Bento Box
10 7/8" L x 8 1/4" W x 2" H
(27.6 x 21 x 5.1 cm)
- BB1WH** White Bento Box
10 7/8" L x 8 1/4" W x 2 3/4" H
(27.6 x 21 x 7 cm)
- BBLWH** White Lid/Tray
10 7/8" L x 8 1/4" W x 3/4" H
(27.6 x 21 x 1.9 cm)
- BBLWM** White Marble Lid/Tray
10 7/8" L x 8 1/4" W x 3/4" H
(27.6 x 21 x 1.9 cm)



BENTO BOXES ARE
CONVENIENTLY STACKABLE





THE DEL MAR COLLECTION BPA FREE

Poolside food service presents a unique set of challenges, and the Del Mar Collection is designed to meet all of them. Crafted from lightweight ABS plastic (a BPA-free, dishwasher-safe material), these stackable serving boxes can be used as both delivery trays and dinnerware. With stylish water-inspired details and modular design, they're the ideal way to present light fare indoors and out. Just remember to wait 30 minutes before going back in.

Rectangular Serving Bowls and Lids

Gray

- BL11G** Lid/Platter, 11 $\frac{3}{8}$ " L x 8 $\frac{3}{8}$ " W x 1 $\frac{1}{8}$ " H (28.9 x 21.3 x 2.9 cm)
- B11G** Bowl, 96 oz. (2.8 L)
11" L x 7 $\frac{7}{8}$ " W x 3" H (28 x 20 x 7.6 cm)
- BL14G** Lid/Platter, 14 $\frac{1}{4}$ " L x 10 $\frac{1}{2}$ " W x 1 $\frac{1}{8}$ " H (36.2 x 26.7 x 2.9 cm)
- B14G** Bowl, 156 oz. (4.6 L)
13 $\frac{7}{8}$ " L x 10" W x 3" H (35.2 x 25.4 x 7.6 cm)

White

- BL11W** Lid/Platter, 11 $\frac{3}{8}$ " L x 8 $\frac{3}{8}$ " W x 1 $\frac{1}{8}$ " H (28.9 x 21.3 x 2.9 cm)
- B11W** Bowl, 96 oz. (2.8 L)
11" L x 7 $\frac{7}{8}$ " W x 3" H (28 x 20 x 7.6 cm)
- BL14W** Lid/Platter, 14 $\frac{1}{4}$ " L x 10 $\frac{1}{2}$ " W x 1 $\frac{1}{8}$ " H (36.2 x 26.7 x 2.9 cm)
- B14W** Bowl, 156 oz. (4.6 L)
13 $\frac{7}{8}$ " L x 10" W x 3" H (35.2 x 25.4 x 7.6 cm)

Rectangular Serving Bowl Inserts NEW

- B114W** $\frac{1}{4}$ -Size Insert for B11G and B11W
16 oz. (473.2 mL)
5 $\frac{1}{4}$ " L x 3 $\frac{3}{4}$ " W x 2 $\frac{5}{8}$ " H (13.3 x 9.5 x 6.7 cm)
- B144W** $\frac{1}{4}$ -Size Insert for B14G and B14W
30 oz. (887.2 mL)
6 $\frac{3}{4}$ " L x 4 $\frac{7}{8}$ " W x 2 $\frac{5}{8}$ " H (17.1 x 12.4 x 6.7 cm)
- B112W** $\frac{1}{2}$ -Size Insert for B11G and B11W
38 oz. (1.1 L)
7 $\frac{5}{8}$ " L x 5 $\frac{1}{4}$ " W x 2 $\frac{5}{8}$ " H (19.4 x 13.3 x 6.7 cm)
- B142W** $\frac{1}{2}$ -Size Insert for B14G and B14W
66 oz. (2 L)
9 $\frac{3}{4}$ " L x 6 $\frac{3}{4}$ " W x 2 $\frac{5}{8}$ " H (24.8 x 17.1 x 6.7 cm)



Round Serving Bowls and Lids

Gray

- BL10G** Lid/Plate, 10 $\frac{3}{8}$ " Dia. x 1 $\frac{1}{8}$ " H
(26.4 x 2.9 cm)
- B10G** Bowl, 80 oz. (2.4 L)
10" Dia. x 3" H
(25.4 x 7.6 cm)
- BL12G** Lid/Plate, 12 $\frac{3}{8}$ " Dia. x 1 $\frac{1}{8}$ " H
(31.4 x 2.9 cm)
- B12G** Bowl, 118 oz. (3.5 L)
12" Dia. x 3" H
(30.5 x 7.6 cm)

White

- BL10W** Lid/Plate, 10 $\frac{3}{8}$ " Dia. x 1 $\frac{1}{8}$ " H
(26.4 x 2.9 cm)
- B10W** Bowl, 80 oz. (2.4 L)
10" Dia. x 3" H
(25.4 x 7.6 cm)
- BL12W** Lid/Plate, 12 $\frac{3}{8}$ " Dia. x 1 $\frac{1}{8}$ " H
(31.4 x 2.9 cm)
- B12W** Bowl, 118 oz. (3.5 L)
12" Dia. x 3" H
(30.5 x 7.6 cm)

Round Serving Bowl Inserts NEW

- B104W** $\frac{1}{4}$ -Size Insert for B10G and B10W
15 oz. (443.6 mL)
4 $\frac{3}{4}$ " L x 4 $\frac{3}{4}$ " W x 2 $\frac{5}{8}$ " H
(12.1 x 12.1 x 6.7 cm)
- B124W** $\frac{1}{4}$ -Size Insert for B12G and B12W
24 oz. (709.8 mL)
5 $\frac{3}{4}$ " L x 5 $\frac{3}{4}$ " W x 2 $\frac{5}{8}$ " H
(14.6 x 14.6 x 6.7 cm)
- B102W** $\frac{1}{2}$ -Size Insert for B10G and B10W
34 oz. (1 L)
9 $\frac{1}{2}$ " L x 4 $\frac{3}{4}$ " W x 2 $\frac{5}{8}$ " H
(24.1 x 12.1 x 6.7 cm)
- B122W** $\frac{1}{2}$ -Size Insert for B12G and B12W
52 oz. (1.5 L)
11 $\frac{1}{2}$ " L x 5 $\frac{3}{4}$ " W x 2 $\frac{5}{8}$ " H
(29.2 x 14.6 x 6.7 cm)



NEW

NB50



NB30



NB56



NB32



MELR6



MELR5



MELR11



MELR9



MELR8



Noodle Bowls NEW

Serve up today's global fare in our traditional yet contemporary noodle bowls. Featuring a sleek dual-toned finish and the most common capacities, these bowls create a beautiful backdrop for your noodle creations.

- NB30** 30 oz. (887.2 mL)
6 3/4" Dia. x 3 1/2" H (17.1 x 8.9 cm)
- NB32** 32 oz. (946.4 mL)
8" Dia. x 3" H (20.3 x 7.6 cm)
- NB50** 50 oz. (1.5 L)
7 1/2" Dia. x 3 7/8" H (19.1 x 9.8 cm)
- NB56** 56 oz. (1.7 L)
10" Dia. x 3 3/8" H (25.4 x 8.6 cm)

Shallow Round Melamine Bowls

Whether you serve poke bowls, açai bowls or regular old mac & cheese, these beautiful white pieces will present your creations with style.

- MELR5** 8 oz. (236.6 mL)
5 1/4" Dia. x 1" H (13.3 x 2.5 cm)
- MELR6** 14 oz. (414 mL)
6 5/8" Dia. x 1 3/8" H (16.8 x 3.5 cm)
- MELR8** 28 oz. (828 mL)
8" Dia. x 1 3/4" H (20.3 x 4.4 cm)
- MELR9** 46 oz. (1.4 L)
9 1/2" Dia. x 2 1/8" H (24.1 x 5.4 cm)
- MELR11** 86 oz. (2.5 L)
11 1/4" Dia. x 2 3/8" H (28.6 x 6 cm)

Tabletop Accessories







Shown with BNCB84 coffee caddy and PCR25 creamer

HOT

HTSH5

HTSH3

HTSH1

Taco Holders HOT

In brushed stainless steel, these holders are a fun, modern way to serve anything from tacos to hot dogs to cannoli.

Full-Size

- TSH1** 1 or 2 Compartments
5" L x 4" W x 2" H
(12.7 x 10.2 x 5.1 cm)
- TSH3** 2 or 3 Compartments
8" L x 4" W x 2" H
(20.3 x 10.2 x 5.1 cm)
- TSH5** 4 or 5 Compartments
13 ¼" L x 4" W x 2" H
(33.7 x 10.2 x 5.1 cm)

Half-Size

- HTSH1** 1 or 2 Compartments
5" L x 2" W x 2" H
(12.7 x 5.1 x 5.1 cm)
- HTSH3** 2 or 3 Compartments
8" L x 2" W x 2" H
(20.3 x 5.1 x 5.1 cm)
- HTSH5** 4 or 5 Compartments
13 ¼" L x 2" W x 2" H
(33.7 x 5.1 x 5.1 cm)

Mini

- MTSH1** 1 or 2 Compartments
2" L x 2" W x 1" H
(5.1 x 5.1 x 2.6 cm)
- MTSH3** 2 or 3 Compartments
4" L x 2" W x 1" H
(10.2 x 5.1 x 2.5 cm)
- MTSH5** 4 or 5 Compartments
7" L x 2" W x 1" H
(17.8 x 5.1 x 2.5 cm)



HOT

MTSH1

MTSH5

MTSH3



THMW3 shown with
FSR11 serving peel
and MB3 sauce cup

Faux Slate Melamine Taco Holders

These must-have pieces pair two trends: the look of slate and the love of tacos. Each of these reversible designs is crafted from dishwasher-safe melamine.

White

- THMW1** 1 or 2 Compartments
5" L x 3" W x 2" H
(12.7 x 7.6 x 5.1 cm)
- THMW3** 2 or 3 Compartments
8" L x 3" W x 2" H
(20.3 x 7.6 x 5.1 cm)
- THMW5** 4 or 5 Compartments
13 ¼" L x 3" W x 2" H
(33.7 x 7.6 x 5.1 cm)

Black

- THMB1** 1 or 2 Compartments
5" L x 3" W x 2" H
(12.7 x 7.6 x 5.1 cm)
- THMB3** 2 or 3 Compartments
8" L x 3" W x 2" H
(20.3 x 7.6 x 5.1 cm)
- THMB5** 4 or 5 Compartments
13 ¼" L x 3" W x 2" H
(33.7 x 7.6 x 5.1 cm)

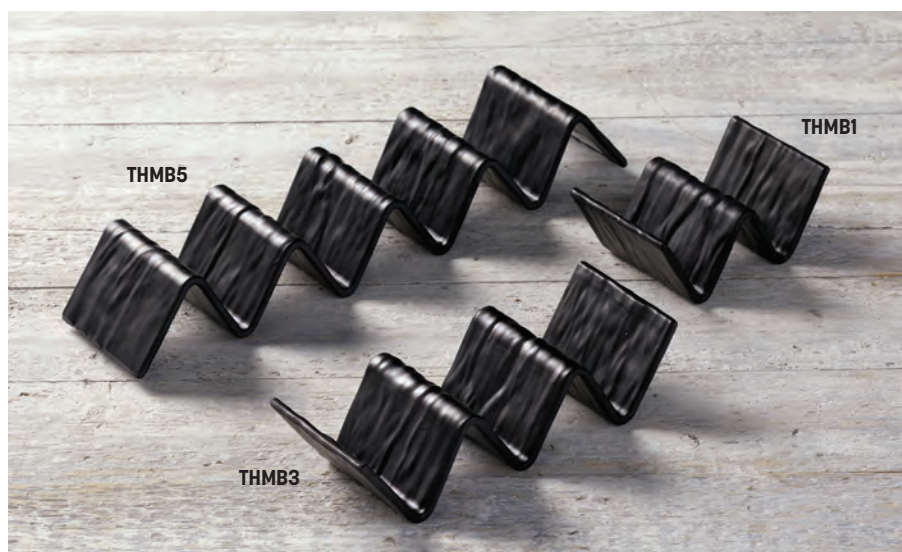

Acacia Wood Taco Holder

This is one of those designs that will make your customers say, "Why haven't I seen this before?" This beautiful, surprisingly simple piece holds up to eight tacos and delivers instant delight.

- THW8** 8-Compartment
16 ½" L x 2 ¾" W x 2 ⅜" H
(41 x 7 x 6 cm)

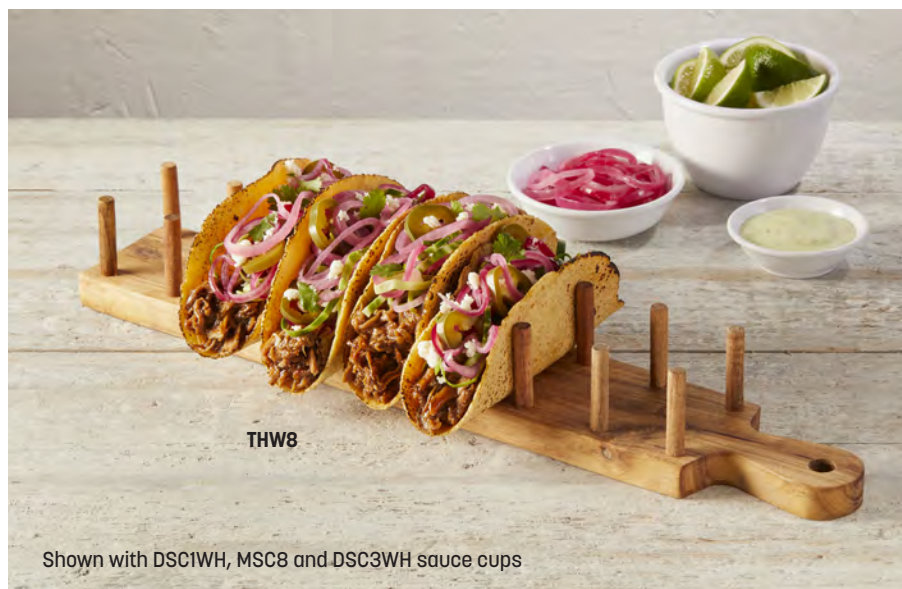

Shown with DSC1WH, MSC8 and DSC3WH sauce cups



THESE TINY POTS RANGE
FROM JUST 4 OZ. TO 24 OZ.

Mini Pots with Lids

There's nothing miniature about the charm and nostalgia created by these stainless steel replicas.

- MPL4** 4 oz. (118.3 mL)
2 5/8" Dia. x 1 3/4" H, 3 1/4" L with Handles
(6.7 x 4.4, 8.3 cm)
- MPL8** 8 oz. (236.6 mL)
3 1/2" Dia. x 2 1/2" H, 4" L with Handles
(8.9 x 6.3, 10.2 cm)
- MPL14** 14 oz. (414 mL)
4 1/4" Dia. x 3" H, 5 1/2" L with Handles
(10.8 x 7.6, 14 cm)
- MPL24** 24 oz. (709.8 mL)
5" Dia. x 3 1/4" H, 6 1/4" L with Handles
(12.7 x 8.3, 15.9 cm)

Oval Hammered Mini Skillets

These stainless steel skillets are individually hammered for oven-to-table elegance.

- MPS14** 14 oz. (414 mL)
6 3/4" L x 5 1/2" W x 1 1/2" H
11 3/4" L with Handle
(17.1 x 14 x 3.8, 29.8 cm)
- MPS22** 22 oz. (650.6 mL)
8" L x 6 1/4" W x 1 3/8" H
12 5/8" L with Handle
(20.3 x 15.9 x 3.5, 32.1 cm)



MPS22 shown on
TRV085 silicone trivet
with HAMSC sauce cup
and SSSK knife

MPS14



SHSP53 shown with TRVR5 silicone trivet

SHSP32

SHSP21

Mini Cookware

Creative appetizers and desserts call for creative stainless steel serving vessels.

Pots

SHSP21 5 oz. (147.9 mL)
2 ¾" Dia. x 1 ¾" H
5 ½" L with Handle
(7.0 x 4.4, 14 cm)

SHSP32 12 oz. (354.9 mL)
3 ½" Dia. x 2 ½" H
6 ¼" L with Handle
(8.9 x 6.3, 15.9 cm)

SHSP53 27 oz. (798.5 mL)
4 ¾" Dia. x 3" H
9 ¼" L with Handle
(12.1 x 7.6, 23.5 cm)

Fry Pans

SHSP20 2 ½ oz. (73.9 mL)
2 ¾" Dia. x 1" H
5 ½" L with Handle
(7 x 2.5, 14 cm)

SHSP40 7 ½ oz. (221.8 mL)
4" Dia. x 1 ¼" H
7 ½" L with Handle
(10.2 x 3.2, 19.1 cm)

SHSP41 13 oz. (384.5 mL)
4 ¾" Dia. x 1 ½" H
9 ⅛" L with Handle
(12.1 x 3.8, 23.2 cm)



SHSP40

SHSP41

SHSP20

A MEMORABLE WAY TO PRESENT INDIVIDUAL SERVINGS AND SHARED SIDES

Mini Induction-Ready Cookware

Induction cooking gets the kitchen-to-table treatment with these contemporary stainless steel pieces.

SHIP32 Pot
12 oz. (354.9 mL)
3 ½" Dia. x 2 ½" H
6 ¼" L with Handle
(8.9 x 6.3, 15.9 cm)

SHIP41 Fry Pan
13 oz. (384.5 mL)
4 ¾" Dia. x 1 ½" H
9 ⅛" L with Handle
(12.1 x 3.8, 23.2 cm)

Mini Roasting Pans

A customer favorite, these petite stainless steel roasting pans deliver practicality and pretty presentation.

MRPS45 14 oz. (414 mL)
4 ½" Sq. x 1 ¾" H
6 ⅞" L with Handles
(11.4 x 4.4, 15.6 cm)

MRP53 17 oz. (502.8 mL)
5 ¾" L x 3 ¾" W x 1 ¾" H
7 ¼" L with Handles
(14.5 x 9.5 x 4.4, 18.4 cm)

MRPS55 26 oz. (768.9 mL)
5 ½" Sq. x 2" H
7 ¼" L with Handles
(14 x 5.1, 18.4 cm)



Shown with HM11CMF fork and HM8TNG tongs



BD93

BD87

BD72



BD65

BD55

BD45

BD35

Stainless Steel Balti Dishes

It's easy to see your own creations making an impact with the help of the beautiful mirror finish on these pieces. Stylish handles make transport easy.

- BD35** 10 oz. (295.7 mL)
4 1/4" Dia. x 2 3/4" H, 4 3/4" W with Handles
(10.87 x 7, 12.1 cm)
- BD45** 16 oz. (473.2 mL)
5 1/8" Dia. x 2 1/2" H, 6 1/2" W with Handles
(13 x 6.4, 16.5 cm)
- BD55** 18 oz. (532.3 mL)
5 3/4" Dia. x 2 3/4" H, 7 1/4" W with Handles
(14.6 x 7, 18.4 cm)
- BD65** 32 oz. (946.4 mL)
6 5/8" Dia. x 3 1/4" H, 8" W with Handles
(16.9 x 8.3, 20.3 cm)
- BD72** 40 oz. (1.2 L)
7" Dia. x 4" H, 8 7/8" W with Handles
(17.8 x 10.2, 22.5 cm)
- BD87** 62 oz. (1.8 L)
8 1/8" Dia. x 4 1/4" H, 9 7/8" W with Handles
(20.6 x 10.8, 25.1 cm)
- BD93** 105 oz. (3.1 L)
9 3/8" Dia. x 4 3/4" H, 11" W with Handles
(23.8 x 12.1, 27.9 cm)

SMALLEST TO LARGEST:
BD35, BD45, BD55, BD65,
BD72, BD87, BD93



Sizzle Platters

Mirror finish on aluminum. Hardwood underliners are sold separately.

PLA710 Sizzle Platter
10 1/2" L x 7" W (26.7 x 17.8 cm)

PLA810 Sizzle Platter
11 1/2" L x 8" W (29.2 x 20.3 cm)

PLA912 Sizzle Platter
12 1/2" L x 9" W (31.8 x 22.9 cm)

WPU71 Wood Holder for PLA710
11 1/2" L x 8 1/4" W x 3/4" H (29.2 x 21 x 1.9 cm)

WPU81 Wood Holder for PLA810
12 1/2" L x 9 1/4" W x 3/4" H (31.8 x 23.5 x 1.9 cm)

WPU91 Wood Holder for PLA912
13 1/2" L x 9 3/4" W x 3/4" H (34.3 x 24.8 x 1.9 cm)

Stainless Steel Mussel Server

Elevate mussels and fish stews with this nautically elegant server.

SSMS9 64 oz. (1.9 L) Server with Lid
7" Dia. x 6 3/4" H, 9" W with Handles
(17.8 x 17.1, 22.9 cm)



PLA710 shown with WPU71



PLA810 shown with WPU81



PLA912 shown with WPU91



Shown with HMRT814 hammered tray

LID IS PERFECT FOR SHELL DISPOSAL

SSMS9



HOT

CAST IRON

Take our pre-seasoned cast iron pots, pans and casseroles out of the oven and onto the table. Larger sizes available on pg. 168-169.

Fry Pans and Casseroles **HOT**

CIPRT5336 9 ½ oz. (280.9 mL)
5 ¾" L x 3 ⅝" W x 1 ½" H, 7" L with Handles
(13.7 x 9.2 x 3.8, 17.8 cm)

CIPS61 9 ½ oz. (280.9 mL)
NEW 5 ¾" Sq. x ⅞" H, 7 ⅝" L with Handles
(14.6 x 2.2, 18.1 cm)

CIS41 3 ½ oz. (103.5 mL)
3 ⅞" Dia. x ¾" H, 6 ⅞" L with Handle
(9.8 x 1.9, 17.5 cm)

CIS51 8 ½ oz. (251.4 mL)
5" Dia. x 1 ½" H, 8 ¼" L with Handle
(12.7 x 3.8, 21 cm)

CIS61 15 ½ oz. (458.4 mL)
6 ¼" Dia. x 1 ¼" H, 10" L with Handle
(15.9 x 3.2, 25.4 cm)

Round Casseroles and Pots **HOT**

CIPR5125 8 ½ oz. (251.4 mL)
NEW 5" Dia. x 1 ¼" H, 6 ½" L with Handles
(12.7 x 3.2, 16.5 cm)

CIPR6250 19 oz. (561.9 mL)
6 ¼" Dia. x 1 ½" H, 8 ¾" L with Handles
(15.9 x 3.8, 22.2 cm)

CIPR7251 27 oz. (798.5 mL)
7 ¼" Dia. x 1 ⅝" H, 9 ⅝" L with Handles
(18.4 x 4.1, 24.5 cm)

CIPR42 9 oz. (266.2 mL)
4" Dia. x 1 ⅝" H, 5 ⅝" L with Handles, 3" H with Knob
(12.7 x 4.1, 14.3, 6 cm)

CIPR5500 19 oz. (561.9 mL)
5" Dia. x 2 ¼" H, 6 ½" L with Handles, 3 ¾" H with Knob
(12.7 x 5.7, 16.5, 9.5 cm)

CIPR5526 27 oz. (798.5 mL)
5 ½" Dia. x 2 ⅜" H, 7 ⅝" L with Handles, 4" H with Knob
(14 x 6 cm, 19.4, 10.2 cm)

Oval Casseroles and Pots

CIPOV856 27 oz. (798.5 mL)
8 ½" L x 6" W x 1 ¾" H, 10 ⅞" L with Handles
(21.6 x 15.2 x 4.5, 27.6 cm)

CIPOV9567 36 ½ oz. (1.1 L)
9 ½" L x 6 ⅜" W x 2" H, 12" L with Handles
(24.1 x 16.2 x 5.1, 30.5 cm)

CIPOV63 11 ½ oz. (340.1 mL)
5" L x 2 ⅝" W x 1 ¾" H, 6 ½" L with Handles, 3" H with Knob
(12.7 x 6.7 x 4.4, 16.5, 7.6 cm)

CIPOV6040 17 ½ oz. (517.5 mL)
6" L x 4" W x 2 ½" H, 7 ½" L with Handles, 3 ⅞" H with Knob
(15.2 x 10.2 x 6.4, 19.1, 9.8 cm)

CIPOV745 23 ½ oz. (695 mL)
7" L x 4 ½" W x 2 ¾" H, 8 ½" L with Handles, 4" H with Knob
(17.8 x 11.4 x 7, 21.6, 10.2 cm)

Mini Griddle **NEW**

CIG85 8 ¼" L x 5 ¾" W x ¾" H, 9 ½" L with Handles
(21 x 14.6 x 1.9, 24.1 cm)



HOT



NEW

FEATURES
DUAL-SIDED
SURFACE

CIG85

Mini Cast Iron Fondue Pot and Stand

- CIFD** Cast Iron Pot, 12 ½ oz. (369.7 mL)
4 ⅝" Dia. x 1 ¾" H, 7 ⅞" L with Handle
(11.7 x 4.5, 18.1 cm)
- CIFDR** Stainless Steel Stand
5" Dia. x 3 ¼" H
(12.7 x 8.3 cm) (Tea lights not included)



Silicone Trivets

- TRVR5** Round
5" Dia. x ¼" H
(12.7 x 0.6 cm)
- TRVR675** Round
6 ¾" Dia. x ¼" H
(17.1 x 0.6 cm)
- TRV053** Oval
5 ½" L x 3 ¾" W x ¼" H
(14 x 9.5 x 0.6 cm)
- TRV085** Oval
8 ¾" L x 5 ⅞" W x ¼" H
(22.2 x 14.9 x 0.6 cm)



Steak Knives

- KNF2** 5" L Blade, 9" L Overall
(12.7 x 22.9 cm)
Black Plastic Handle, Rounded Tip
- KNF7** 4 ½" L Blade, 8 ¾" L Overall
(11.4 x 22.2 cm)
Pom, Full Tang, Pointed Tip
- KNF6** 5" L Blade, 10" L Overall
(12.7 x 25.4 cm)
Jumbo Black Plastic, Rounded Tip
- KNF3** 5 ⅞" L Blade, 10" L Overall
(13 x 25.4 cm)
Hardwood Handle, Rounded Tip
- KNF4** 4 ¾" L Blade, 8" L Overall
(11.1 x 20.3 cm)
Pakkawood Handle, Pointed Tip
- KNF8** 5" L Blade, 10" L Overall
(12.7 x 25.4 cm)
Jumbo Black Pom, Full Tang, Rounded Tip
- SSKNF9** 5" L Blade, 9" L Overall
(12.7 x 22.9 cm)
Satin Finish
- SSKNF8** 5" L Blade, 9" L Overall
(12.7 x 22.9 cm)
Mirror Finish
- SSSK** 5 ⅞" L Blade, 10 ¼" L Overall
(13 x 26 cm)
Jumbo Black Pom, Full Tang





Melamine Cast Iron Pots

The rustic look of cast iron meets the lightweight of melamine in these serving dishes. They're easy to wash and even easier to carry. Not for oven or stove use.

MC61 Oval Casserole, 5 ¼ oz. (155.3 mL)
4 ¾" L x 3" W x 1 ¼" H
6" L with Handles
(12.1 x 7.6 x 3.2, 15.2 cm)

MC41 Round Casserole, 7 oz. (207 mL)
4 ¾" Dia. x 1 ¼" H
6" L with Handles
(11.1 x 3.2, 15.2 cm)

MFP41 Fry Pan, 7 oz. (207 mL)
4 ¾" Dia. x 1 ¼" H
6 ¼" L with Handle
(12.1 x 3.2, 15.9 cm)

MCR72 Round Casserole, 39 oz. (1.2 L)
7 ¾" Dia. x 2 ¾" H
9 ¾" L with Handles
(19.4 x 6, 25.1 cm)

MC81 Oval Casserole, 13 oz. (384.5 mL)
8 ¼" L x 5 ½" W x 1 ½" H
10 ¾" L with Handles
(21 x 14 x 3.4, 26.4 cm)

MFP81 Fry Pan, 24 oz. (709.8 mL)
8 ½" Dia x 1 ¼" H
12" L with Handles
(21.6 x 3.2, 30.5 cm)

MB93 Round Bowl, 82 oz. (2.4 L)
9 ¾" Dia. x 3 ¼" H
12 ½" L with Handles
(24.8 x 8.3, 31.8 cm)

Melamine Square Jars

Our most popular glass square jars are available in durable melamine! Organize, serve and store in these simple and nestable white melamine jars. Use alone or with our condiment racks, even top with a PET lid to keep food covered.

- MSJ3** 10 oz. (295.7 mL)
3" Sq. x 3" H (7.6 x 7.6 cm)
- MSJ4** 22 oz. (650.6 mL)
4" Sq. x 4" H (10.2 x 10.2 cm)
- MSJ5** 44 oz. (1.3 L)
4 7/8" Sq. x 5" H (12.4 x 12.7 cm)

Pet Lids

- LGJ8** 3" Sq. x 3/8" H (7.6 x 1 cm)
- LGJ24** 4" Sq. x 3/8" H (10.2 x 1 cm)
- LGJ40** 5" Sq. x 3/8" H (12.7 x 1 cm)



MSJ5 jars shown with BR15 multifunctional riser

Terra Cotta Melamine Pots

Customers everywhere are intrigued by these cleverly designed pieces. These pots pair the look of earthenware with the durability you've come to expect from our melamine collection. Bring al fresco color to whatever you serve in them.

- MELPOT2** 3 1/2 oz. (103.5 mL)
2 3/4" Dia. x 2 3/8" H (7 x 6 cm)
- MELPOT8** 8 oz. (236.6 mL)
3 1/2" Dia. x 3 1/8" H (8.9 x 7.9 cm)
- MELPOT14** 16 oz. (473.2 mL)
4 3/8" Dia. x 4" H (11.1 x 10.2 cm)
- MELPOT24** 28 oz. (828.1 mL)
5 1/4" Dia. x 4 3/4" H (13.3 x 12.1 cm)



MSJ4 shown with LGJ24 lid

MSJ3

MSJ5



MELPOT24

MELPOT14

MELPOT2

MELPOT8



Mini Apothecary Jars

Blending the trends of miniatures and jars, these rustic pieces are sure to please.

- HMMJ1** 1 ½ oz. (44.4 mL)
NEW 1 ¾" Dia. (2 ½" Dia. with Hinges) x 2 ½" H
 (4.4 (6.4) x 6.4 cm)
- HMMJ2** 2 ½ oz. (73.9 mL)
 1 ¾" Dia. (2 ½" Dia. with Hinges) x 3 ½" H
 (4.4 (6.4) x 8.9 cm)
- HMMJ3** 3 ½ oz. (103.5 mL)
 2 ¼" Dia. (3 ¼" Dia. with Hinges) x 2 ¾" H
 (5.7 (8.3) x 7 cm)
- HMMJ4** 4 oz. (118.3 mL)
 1 ¾" Dia. (2 ½" Dia. with Hinges) x 3 ¼" H
 (4.4 (6.4) x 8.3 cm)
- HMMJ5** 5 oz. (147.9 mL)
 2 ¼" Dia. (3 ¼" Dia. with Hinges) x 3" H
 (5.7 (8.3) x 7.6 cm)

Apothecary Jars

The full-size versions of our rustic apothecary jars are perfect for pickling and presentation alike.

- HMJ4** 16 oz. (473.2 mL)
 3 ½" Dia. (4 ½" Dia. with Hinges) x 4" H
 (8.9 (11.4) x 10.2 cm)
- HMJ5** 26 oz. (768.9 mL)
 3 ½" Dia. (4 ½" Dia. with Hinges) x 5 ½" H
 (8.9 (11.4) x 14 cm)
- HMJ6** 35 oz. (1 L)
 3 ½" Dia. (4 ¾" Dia. with Hinges) x 6 ½" H
 (8.9 (12.1) x 16.5 cm)



Mason Jars

With the popularity of pickling and fermentation, it's the ideal time to serve food or drinks in these classic glass pieces.

- MJ85** 8 ½" oz. (251.4 mL)
3" Dia. x 4" H (7.6 x 10.2 cm)
- MJ17** 17 oz. (502.8 mL)
3 ⅜" Dia. x 5 ⅜" H (8.6 x 13.7 cm)
- MJ16** 16 oz. (473.2 mL)
4 ⅜" Dia. x 4 ⅜" H (11.1 x 11.1 cm)
- MJ22** 22 oz. (650.6 mL)
4 ⅜" Dia. x 5 ½" H (11.1 x 14 cm)

PET Lids

- LMJ1785** MJ17 Lid and MJ85 Lid
2 ⅞" Dia. x ⅜" H (7.3 x 1 cm)
- LMJ1622** MJ16 Lid and MJ22 Lid
3 ⅞" Dia. x ⅜" H (9.8 x 1 cm)
(not shown)

Mason Jar Sanitizer Pump

Easily and safely dispense hand sanitizer with this stainless steel sanitizer pump. Compatible with glass mason jars (MJ17, MJ85) and plastic mason jars (PMJ16, PMJ26). Jar sold separately.

- MJP3** Mason Jar Lid with Pump
3" Dia. x 3" H (7.6 x 7.6 cm)





Glass Zipper Bags

Your customers will reach for their phones when they see these memorable, social media-worthy glass containers.

- GZB7** 7 oz. (207 mL)
3 1/2" Dia. x 3 1/2" H (8.9 x 8.9 cm)
- GZB22** 22 oz. (650.6 mL)
5" Dia. x 4 3/4" H (12.7 x 12 cm)

Round Glass Jars

These simple, versatile 4- and 6-oz. jars practically beg for imaginative uses.

- RGJ4** 4 oz. (118.3 mL)
2" Dia. x 2 7/8" H (5.1 x 7.3 cm)
- RGJ6** 6 oz. (177.4 mL)
2 5/8" Dia. x 3 1/8" H (6.7 x 7.9 cm)

Plastic Cap

- LRGJ6** RGJ4 and RGJ6 Lid
2 5/8" Dia. x 3/8" H (6.7 x 1 cm)

Square Glass Jars

Our trendy geometric jars are great for front- and back-of-house. Feeling adventurous? Use them to serve drinks.

- GJ6** 6 oz. (177.4 mL)
2 1/2" Sq. x 2 1/2" H (6.4 x 6.4 cm)
- GJ8** 8 oz. (236.6 mL)
3" Sq. x 3" H (7.6 x 7.6 cm)
- GJ24** 24 oz. (709.8 mL)
4" Sq. x 4" H (10.2 x 10.2 cm)
- GJ40** 40 oz. (1.2 L)
4 3/4" Sq. x 4 7/8" H (12.1 x 12.4 cm)
- GJ72** 72 oz. (2.1 L)
5 3/4" Sq. x 6" H (14.6 x 15.2 cm)

PET Lids

- LGJ6** GJ6 Lid, 2 5/8" Sq. x 3/8" H (6.7 x 1 cm)
- LGJ8** GJ8 Lid, 3" Sq. x 3/8" H (7.6 x 1 cm)
- LGJ24** GJ24 Lid, 4" Sq. x 3/8" H (10.2 x 1 cm)
- LGJ40** GJ40 Lid, 5" Sq. x 3/8" H (12.7 x 1 cm)
- LGJ72** GJ72 Lid, 6" Sq. x 3/8" H (15.2 x 1 cm)





Glass Milk Bottles

With a winsome combination of nostalgia and playfulness, these milk bottles will particularly please at brunches and catered events.

- GMB3** 3 oz. (88.7 mL)
1 3/4" Dia. x 4" H (4.5 x 10.2 cm)
- GMB6** 6 oz. (177.4 mL)
2" Dia. x 5" H (5.1 x 12.7 cm)
- GMB8** 8 oz. (233.6 mL)
2 1/4" Dia. x 5 1/2" H (5.7 x 14 cm)
- GMB16** 16 oz. (473.2 mL)
2 3/4" Dia. x 6 1/2" H (7 x 16.5 cm)
- GMB32** 32 oz. (946.4 mL)
3 1/4" Dia. x 8 1/4" H (8.3 x 21 cm)

PET Lids

- LGMB3** GMB3 Lid, 1 1/2" Dia. x 3/8" H (3.8 x 1 cm)
- LGMB68** GMB6 and GMB8 Lid
1 7/8" Dia. x 3/8" H (4.8 x 1 cm)
- LGMB16** GMB16 Lid, 2 1/4" Dia. x 3/8" H (5.7 x 1 cm)

Plastic Caps

- CAP3** GMB3 Lid, 1 1/2" Dia. x 3/8" H (3.8 x 1 cm)
- CAP6** GMB6 Lid, 1 3/4" Dia. x 3/8" H (4.4 x 1 cm)
- CAP8** GMB8 Lid, 2" Dia. x 3/8" H (5.1 x 1 cm)
- CAP16** GMB16 Lid, 2 3/8" Dia. x 3/8" H (6 x 1 cm)
- CAP32** GMB32 Lid, 2 3/8" Dia. x 1/2" H (6 x 1.3 cm)



Plastic Mason Jars

Love the look of a mason jar but the durability of plastic? We have the answer with our crystal clear, break-resistant plastic mason jars. Top it off for travel with our plastic lid option.

- PMJ16** 16 oz. (473.2 mL)
3 1/4" Dia. x 4 5/8" H (8.3 x 16.5 cm)
- PMJ26** 26 oz. (768.9 mL)
3 1/2" Dia. x 5 1/2" H (8.9 x 14 cm)
- PMJL** Silver Lid
Fits PMJ16, PMJ26, MJ85 and MJ17

Plastic Beverage Bottles

These clear PET one-time use beverage bottles make for ideal to-go drink options. Each bottle comes with an aluminum screw-on lid. **Sold in a pack of 12.**

- BV8** 8 oz. (236.6 mL)
 2 3/8" Dia. x 4 1/2" H (6 x 11.4 cm)
- BV12** 12 oz. (354.9 mL)
 3" Dia. x 4 3/4" H (7.6 x 12.1 cm)
- BV16** 16 oz. (473.2 mL)
3" Dia. x 5 3/4" H (7.6 x 14.6 cm)
- BV20** 20 oz. (591.5 mL)
3" Dia. x 6 3/4" H (7.6 x 17.1 cm)





FFHM37

FFC337



FFCS45

FFHM45



Shown with
FFHM37 fry cup,
HAMSC sauce cups and
MJ17 mason jar

FFC335

FFHM35

OVERSIZED DESIGN FOR
BIGGER BITES

Stainless Steel Fry Cups HOT

Among our most popular items, these pieces come in two different shapes and finishes to make your frites pop.

Straight-Sided

FFC337 Satin Finish
14 oz. (414 mL)
3 3/8" Dia. x 3 3/8" H (8.6 x 8.6 cm)

FFHM37 Hammered Finish
14 oz. (414 mL)
3 3/8" Dia. x 3 3/8" H (8.6 x 8.6 cm)

Angled

FFCS45 Satin Finish
12 oz. (354.9 mL)
2 7/8" Dia. x 4 1/2" H (7.3 x 11.4 cm)

FFHM45 Hammered Finish
12 oz. (354.9 mL)
2 7/8" Dia. x 4 1/2" H (7.3 x 11.4 cm)

Large Stainless Steel Fry Cups

Don't let fries have all the fun. Serve appetizers, snacks and other sides in these stainless steel beauties.

FFC335 Satin Finish
24 oz. (709.8 mL)
4" Dia. x 4 1/2" H (10.2 x 11.4 cm)

FFHM35 Hammered Finish
24 oz. (709.8 mL)
4" Dia. x 4 1/2" H (10.2 x 11.4 cm)

Square Hammered Fry Cups

Our popular stainless steel fry cups with a little more edge. (Four of them, to be exact.)

FCH35 12 oz. (354.9 mL)
3 1/4" Sq. x 3 1/2" H (8.3 x 8.9 cm)

FCH325 18 oz. (532.3 mL)
3 3/8" Sq. x 3 3/8" H (9.2 x 9.2 cm)



FCH325

FCH35



Round Stainless Steel Fry Cups

A new, shorter take on our popular fry cup design, these pieces are great for mixing up your side service.

SC9 Satin Finish, 9 oz. (266.2 mL)
2 5/8" Dia. x 2 3/4" H (77.6 x 81.3 cm)

SCH9 Hammered Finish, 9 oz. (266.2 mL)
2 5/8" Dia. x 2 3/4" H (77.6 x 81.3 cm)

Oval Stainless Steel Fry Cups

Oblong design gives these new fry cups a contemporary twist, and makes them ideal for wide sides like onion rings.

FCS55 Satin Finish, 5 1/2 oz. (162.7 mL)
2 5/8" L x 2 1/4" W x 2 3/4" H (6.7 x 5.7 x 7 cm)

FCH55 Hammered Finish, 5 1/2 oz. (162.7 mL)
2 5/8" L x 2 1/4" W x 2 3/4" H (6.7 x 5.7 x 7 cm)

FCS12 Satin Finish, 12 oz. (354.9 mL)
3 1/2" L x 2 7/8" W x 3 5/8" H (8.9 x 7.3 x 9.2 cm)

FCH12 Hammered Finish, 12 oz. (354.9 mL)
3 1/2" L x 2 7/8" W x 3 5/8" H (8.9 x 7.3 x 9.2 cm)

Copper Fry Cups

Our most popular fry cup designs are now available in upscale copper. Choose from brushed or hammered finishes in angled or straight-sided designs.

Straight-Sided

FFCCS337 Satin Finish, 14 oz. (414 mL)
3 3/8" Dia. x 3 3/8" H (8.6 x 8.6 cm)

FFCCH37 Hammered Finish, 14 oz. (414 mL)
3 3/8" Dia. x 3 3/8" H (8.6 x 8.6 cm)

Angled

FFCCS45 Satin Finish, 12 oz. (354.9 mL)
2 7/8" Dia. x 4 1/2" H (7.3 x 11.4 cm)

FFCCH45 Hammered Finish, 12 oz. (354.9 mL)
2 7/8" Dia. x 4 1/2" H (7.3 x 11.4 cm)





SCS3

SCSM



SCB3

SCBM

Stainless Steel Soup Cans

In black or silver, these cans elevate an easily overlooked object.

Silver

SCSM 12 oz. (354.9 mL)
2 3/4" Dia. x 3 3/4" H (7 x 9.5 cm)

SCS3 12 oz. (354.9 mL)
2 3/4" Dia. x 3 3/4" H (7 x 9.5 cm)

Black

SCBM 12 oz. (354.9 mL)
2 3/4" Dia. x 3 3/4" H (7 x 9.5 cm)

SCB3 12 oz. (354.9 mL)
2 3/4" Dia. x 3 3/4" H (7 x 9.5 cm)



Shown with SSP2 shakers and TMW13 serving tray

Classic Mint Julep Cups

Featuring elegant beading and a mirrored finish, these stunning cups will have your mint julep presentation off to the races.

- JC12** 12 oz. (354.9 mL)
3 3/8" Dia. x 4 1/2" H
(8.6 x 11.4 cm)
- JC16** 16 oz. (473.2 mL)
3 5/8" Dia. x 5 3/4" H
(9.2 x 14.6 cm)
- JC48** 48 oz. (1.4 L)
5 1/4" Dia. x 7 5/8" H
(13.3 x 19.4 cm)



Mint Julep Cups

Serve up Derby Day the other 364 days a year with these brushed stainless steel cups.

- JC8** 8 oz. (236.6 mL)
2 7/8" Dia. x 3 7/8" H
(7.4 x 9.8 cm)
- JC11** 11 oz. (325.3 mL)
3" Dia. x 4 1/4" H
(7.6 x 10.8 cm)
- JC14** 14 oz. (414 mL)
3 1/4" Dia. x 4 5/8" H
(8.3 x 11.8 cm)





FGS337

FGS335

Galvanized Soup Cans

A fun way to make finger food memorable. Not for use with acidic foods.

FGS335 10 oz. (295.7 mL)
3 3/8" Dia. x 3 3/4" H (8.6 x 9.5 cm)

FGS337 20 oz. (591.5 mL)
4" Dia. x 4 1/2" H (10.2 x 11.4 cm)

Galvanized Fry Cups

With a French bistro look, these cups are a chic way to serve fries and dainty desserts. Not for use with acidic foods.

GFC337 12 oz. (354.9 mL)
3 3/4" Dia. x 3 1/4" H (9.5 x 8.3 cm)

GFC45 Angled, 10 oz. (295.7 mL)
3 1/2" Dia. x 4 1/2" H (8.9 x 11.4 cm)

GFC335 24 oz. (709.8 mL)
4 1/4" Dia. x 4 1/2" H (10.8 x 11.4 cm)

Mini Galvanized Pails

Pair with our larger pails (pg. 68) to stylishly coordinate. Not for use with acidic foods.

GP2 3 oz. (88.7 mL)
2 1/2" Dia. x 2 3/4" H (6.4 x 7 cm)

GP3 8 1/2 oz. (251.4 mL)
3 1/2" Dia. x 3 7/8" H (8.9 x 9.8 cm)

GP4 26 oz. (768.9 mL)
4 1/2" Dia. x 5" H (11.4 x 12.7 cm)

Newspaper Fry Cups

A nod to traditional fish and chips presentation, retro newsprint is the inspiration for this press-worthy design. Sold in packs of 1000.

FFCP4 4 oz. (118.3 mL)
2 3/4" Dia. x 4 3/8" H (7 x 11.1 cm)

FFCP6 6 oz. (177.4 mL)
2 7/8" Dia. x 5 1/4" H (7.3 x 13.3 cm)



GFC45

GFC335

GFC337



GP3

GP4

GP2



FFCP6

FFCP4

Mini Stainless Steel Pails HOT

- SSP25** 6 oz. (177.4 mL)
2 1/2" Dia. x 2 3/4" H (6.4 x 7 cm)
- SSP35** 12 oz. (354.9 mL)
3 1/2" Dia. x 3 1/4" H (8.9 x 8.3 cm)
- SSP43** 1 qt. (946.4 mL)
5" Dia. x 4 5/8" H (12.7 x 11.7 cm)
- SSP61** 2 qt. (1.9 L)
6 1/4" Dia. x 5 3/4" H (15.9 x 14.6 cm)



SSP35R

HOT

MIRRORED
STAINLESS STEEL
WORKS IN ANY
SETTING



SSP35

SSP61

SSP43

SSP25

**Mini Dual Finish
Stainless Steel Pail**

- SSP35R** 12 oz. (354.9 mL)
3 1/2" Dia. x 3 1/4" H (8.9 x 8.3 cm)

Mini Stainless Steel Trash Cans

- OSCAR** Can, 14 oz. (414 mL)
3 3/4" Dia. x 3 1/2" H (9.5 x 8.9 cm)
- OLID** Lid for OSCAR
3 3/4" Dia. x 1 1/2" H (9.5 x 3.8 cm)
- OSCAR2** Can, 1 qt. (946.4 mL)
5" Dia. x 4 7/8" H (12.7 x 12.4 cm)
- OLID2** Lid for OSCAR2
5" Dia. x 1 5/8" H (12.7 x 4.1 cm)
- OSCAR3** Can, 2 qt. (1.9 L)
6" Dia. x 5 7/8" H (15.2 x 14.9 cm)
- OLID3** Lid for OSCAR3
6" Dia. x 1 7/8" H (15.2 x 4.8 cm)

Stainless Steel Milk Cans HOT

- MICH25** 2 1/2 oz. (73.9 mL)
2" Dia. x 2 1/4" H (5.1 x 5.7 cm)
- MICH5** 5 oz. (147.9 mL)
2" Dia. x 3" H (5.1 x 7.6 cm)
- MICH10** 10 oz. (285.7 mL)
3 1/8" Dia. x 4" H (7.9 x 10.2 cm)
- MICH15** 15 oz. (443.6 mL)
2 3/4" Dia. x 5" H (7 x 12.7 cm)



OLID3

OSCAR2

OSCAR3

OLID

OLID2

OSCAR



HOT

MICH15

MICH10

MICH5

MICH25

Shown with
SSP35R mini stainless steel pail

HOT



PPCN1212

PPCH3R

PPRW1212

PPRN2121

PPCH2N

PPCH1B

Fry and Basket Paper **HOT**

FDA-approved, biodegradable, compostable, food-safe paper. Sold in packs of 1000.

Flat 10" Square Paper (25.4 cm)

- PPRW1010 White (not shown)
- PPCN1010 Natural Newspaper (not shown)
- PPCH3N Natural (not shown)
- PPRN100 Newspaper (not shown)

Flat 12" Square Paper (30.5 cm)

- PPRW1212 White
- PPCN1212 Natural Newspaper
- PPCH2N Natural
- PPRN2121 Newspaper
- PPCH1B Black Checkerboard
- PPCH3R Red Checkerboard

Flat 16" Square Paper (40.6 cm)

- PPRW1616 White
- PPCH4N Natural
- PPCN1616 Natural Newspaper (not shown)
- PPRN1616 Newspaper

Preformed 7" L x 6" W Grease-Resistant Paper Bags (17.8 x 15.2 cm)

- PPRC76 Natural Newspaper
- PPRN76 Newspaper



PPRN1616

HOT

PPRW1616

PPCH4N

HOT



PPRN76

PPRC76



PPL12 shown with
CKNF2 knife

Leaf Cheese Paper

Conjure up a magical experience with your next cheese board or charcuterie. These clever, grease-resistant, food-safe papers are sure to surprise. **Sold in packs of 250.**

- PPL4** 4 ¼" L x 2 ½" W
(10.8 x 6.3 cm)
- PPL7** 7" L x 4 ½" W
(17.8 x 11.4 cm)
- PPL12** 12" L x 7" W
(30.5 x 17.8 cm)

Mini Snack Bags

Disposable and grease-resistant, these simple sacks aren't just for takeout. **Sold in packs of 250.**

Black

- SBB3** 3 ⅜" L x 1 ¾" W x 3 ½" H
(8.6 x 4.4 x 8.9 cm)
- SBB4** 4 ¼" L x 2 ½" W x 3 ¾" H
(10.8 x 6.3 x 9.5 cm)

White

- SBW3** 3 ⅜" L x 1 ¾" W x 3 ½" H
(8.6 x 4.4 x 8.9 cm)
- SBW4** 4 ¼" L x 2 ½" W x 3 ¾" H
(10.8 x 6.3 x 9.5 cm)

Natural

- SBN3** 3 ⅜" L x 1 ¾" W x 3 ½" H
(8.6 x 4.4 x 8.9 cm)
- SBN4** 4 ¼" L x 2 ½" W x 3 ¾" H
(10.8 x 6.3 x 9.5 cm)





Enamelware

Vintage enamelware is ultra-hot, and this collection is a perfect way to get in on the Americana-inspired craze. Each piece features blue trim on white, a timeless look your customers will love.

- EWM6** Mug, 6 oz. (177.4 mL)
2 7/8" Dia. x 2 3/4" H
(7.3 x 7 cm)
- EWB6** Bowl, 8 oz. (236.6 mL)
6 1/4" L x 4 7/8" W x 1 1/2" H
(15.9 x 12.4 x 3.8 cm)
- EWM16** Mug, 16 oz. (473.2 mL)
3 5/8" Dia. x 4" H
(9.2 x 10.2 cm)
- EWB8** Bowl, 16 oz. (473.2 mL)
7 7/8" L x 5 7/8" W x 1 1/2" H
(20 x 14.9 x 3.8 cm)
- EWB10** Bowl, 32 oz. (946.4 mL)
10" L x 7 5/8" W x 1 7/8" H
(25.4 x 19.4 x 4.8 cm)



Onyx Galvanized Wide Rim Pans

The days of using a standard aluminum pan for serving are over. You now have options! These dark galvanized pans are perfect for anything from pizza to burritos.

FROM SMALLEST
TO LARGEST:

- GTP10**
- GTP12**
- GTP14**
- GTP16**
- GTP18**

- GTP10** 10" Dia. x 3/8" H (25.4 x 1 cm)
- GTP12** 12" Dia. x 3/8" H (30.5 x 1 cm)
- GTP14** 14" Dia. x 3/8" H (35.6 x 1 cm)
- GTP16** 16" Dia. x 3/8" H (40.6 x 1 cm)
- GTP18** 18" Dia. x 3/8" H (45.7 x 1 cm)



Shown with
MJ17 mason jar and
HMMJ3 apothecary jar

Stainless Steel Pie Pans

- 918SS** 9 1/8" Top OD x 7 7/8" Top ID
x 6 7/8" Bottom ID x 1" Deep
(23.2 x 20 x 17.5 x 2.5 cm)
- 1187SS** 10 1/8" Top OD x 9" Top ID
x 8 1/8" Bottom ID x 3/4" Deep
(25.7 x 22.9 x 20.6 x 1.9 cm)
- 1300SS** 13 1/8" Top OD x 11 7/8" Top ID
x 10 3/4" Bottom ID x 7/8" Deep
(33.3 x 30.2 x 27.3 x 2.2 cm)

Aluminum Serving Pans USA

- 1188** 10" Top OD x 9" Top ID
x 7 3/4" Bottom ID x 1 1/4" Deep
(25.4 x 22.9 x 19.7 x 3.2 cm)
- 1190** 11 1/8" Top OD x 10" Top ID
x 8 1/4" Bottom ID x 1 5/16" Deep
(28.3 x 25.4 x 21 x 3.3 cm)
- 1200** 11 7/8" Top OD x 10 7/8" Top ID
x 9 9/8" Bottom ID x 1 1/4" Deep
(30.2 x 27.6 x 23.2 x 3.2 cm)
- 1300** 13 1/8" Top OD x 11 7/8" Top ID
x 10 3/4" Bottom ID x 7/8" Deep
(33.3 x 30.2 x 27.3 x 2.2 cm) (not shown)

Mini Aluminum Pie Pan USA

- 475** 4 3/8" Dia. x 1" Deep (11.1 x 2.5 cm)



1200

1190 shown with FFCS45 fry cup



475

PETITE DESIGN FOR
VERSATILE USE



Hammered Stainless Steel Tubs

These dishwasher-safe pieces are ideal for serving casual entrées like sandwiches and wraps.

- SHT9** Rectangle, 44 oz. (1.3 L)
9 1/8" L x 6 1/8" W x 2" H
(23.2 x 15.6 x 5.1 cm)
- SHT8** Square, 54 oz. (1.6 L)
8" Sq. x 2" H (20.3 x 5.1 cm)
- SHT17** Rectangle, 54 oz. (1.6 L)
10 1/8" L x 7 1/8" W x 2" H
(25.7 x 18.1 x 5.1 cm)
- SHT10** Square, 90 oz. (2.7 L)
10 1/4" Sq. x 2" H (26 x 5.1 cm)

Stainless Steel Pails and Tubs

A dual satin and mirror finish dresses up this collection.

- STUB63** Tub, 27 oz. (798.5 mL)
6 1/8" Dia. x 3" H (15.6 x 7.6 cm)
- STUB69** Oval Tub, 32 oz. (946.4 mL)
8 5/8" L x 5 1/2" W x 2 1/2" H
(21.9 x 14 x 6.3 cm)
- STUB83** Tub, 37 oz. (1.1 L)
8" Dia. x 3 1/8" H (20.3 x 7.9 cm)
- STUB93** Tub, 72 oz. (2.1 L)
8 7/8" Dia. x 3 1/8" H (22.5 x 7.9 cm)
- STUB10** Tub, 88 oz. (2.6 L)
9 3/4" Dia. x 3 1/4" H (24.8 x 8.3 cm)
- STUB12** Tub, 95 oz. (2.8 L)
11 5/8" Dia. x 3 1/4" H (29.5 x 8.3 cm)
- STUB87** Pail, 148 oz. (4.4 L)
8 1/4" Dia. x 7 3/8" H (21 x 18.7 cm)
- STUB20** Tub, 25 qt. (24 L)
20" L x 15" W x 11" H
(50.8 x 38.1 x 27.9 cm)



Natural Galvanized

Pails and Tubs HOT

Hand-wash only. Not for use with acidic foods.

- MTUB63** Tub, 27 oz. (798.5 mL)
6 1/8" Dia. x 3" H (15.6 x 7.6 cm)
- MTUB69** Oval Tub, 32 oz. (946.4 mL)
8 5/8" L x 5 1/2" W x 2 1/2" H
(21.9 x 14 x 6.3 cm)
- MTUB83** Tub, 37 oz. (1.1 L)
8" Dia. x 3 1/8" H (20.3 x 7.9 cm)
- MTUB93** Tub, 72 oz. (2.1 L)
8 7/8" Dia. x 3 1/8" H (22.5 x 7.9 cm)
- MTUB10** Tub, 88 oz. (2.6 L)
9 3/4" Dia. x 3 1/4" H (24.8 x 8.3 cm)
- MTUB12** Tub, 95 oz. (2.8 L)
11 5/8" Dia. x 3 1/4" H (29.5 x 8.3 cm)
- PTUB87** Pail, 148 oz. (4.4 L)
8 1/4" Dia. x 7 3/8" H (21 x 18.7 cm)
- GPTUB20** Tub, 25 qt. (24 L)
20" L x 15" W x 11" H
(50.8 x 38.1 x 27.9 cm)



Hammered Aluminum Entrée Baskets and Cups

In cool contemporary tones, these personal-sized tubs are perfect for presenting all kinds of entrées and sides. Your customers will love the artisanal aesthetic created by the individually hammered design.

Gold

ASPG Sugar Packet Holder/Sauce Cup
6 oz. (177.4 mL)
3 3/8" L x 2 3/8" W x 2" H
(8.3 x 6 x 5.1 cm)

ABHG46 25 oz. (739.3 mL)
6 1/2" L x 4 3/4" W x 2 1/4" H
(16.5 x 12.1 x 5.7 cm)

ABHG69 48 oz. (1.4 L)
9" L x 6" W x 2 1/4" H
(22.9 x 15.2 x 5.7 cm)

Copper

ASPC Sugar Packet Holder/Sauce Cup
6 oz. (177.4 mL)
3 3/8" L x 2 3/8" W x 2" H
(8.6 x 6 x 5.1 cm)

ABHC46 25 oz. (739.3 mL)
6 1/2" L x 4 3/4" W x 2 1/4" H
(16.5 x 12.1 x 5.7 cm)

ABHC69 48 oz. (1.4 L)
9" L x 6" W x 2 1/4" H
(22.9 x 15.2 x 5.7 cm)

Silver

ASPS Sugar Packet Holder/Sauce Cup
6 oz. (177.4 mL)
3 3/8" L x 2 3/8" W x 2" H
(8.6 x 6 x 5.1 cm)

ABHS46 25 oz. (739.3 mL)
6 1/2" L x 4 3/4" W x 2 1/4" H
(16.5 x 12.1 x 5.7 cm)

ABHS69 48 oz. (1.4 L)
9" L x 6" W x 2 1/4" H
(22.9 x 15.2 x 5.7 cm)

Black

ASPB Sugar Packet Holder/Sauce Cup
6 oz. (177.4 mL)
3 3/8" L x 2 3/8" W x 2" H
(8.6 x 6 x 5.1 cm)

ABHB46 25 oz. (739.3 mL)
6 1/2" L x 4 3/4" W x 2 1/4" H
(16.5 x 12.1 x 5.7 cm)

ABHB69 48 oz. (1.4 L)
9" L x 6" W x 2 1/4" H
(22.9 x 15.2 x 5.7 cm)



OUR POPULAR SQUOUND BOWLS NOW
AVAILABLE IN HAMMERED STAINLESS STEEL



Shown with MSTNG5 tongs

Squound Hammered Bowls

- SBH3** 40 oz. (1.2 L)
7" Dia. x 2 1/8" H (17.8 x 5.4 cm)
- SBH5** 67 oz. (2 L)
9" Dia. x 2 3/4" H (22.9 x 7 cm)
- SBH7** 126 oz. (3.7 L)
11" Dia. x 3" H (27.9 x 7.6 cm)

Squound Hammered Snack Bowls

- SBH325** 3 oz. (100 mL)
3 1/8" Dia. x 1 1/2" H (7.9 x 3.8 cm)
- SBH400** 5 1/2 oz. (200 mL)
3 1/4" Dia. x 1 1/2" H (8.3 x 3.8 cm)
- SBH450** 9 1/2 oz. (300 mL)
4 1/2" Dia. x 2 1/2" H (11.4 x 6.4 cm)
- SBH575** 15 oz. (400 mL)
5 3/4" Dia. x 2 1/2" H (14.6 x 6.4 cm)

Moroccan Hammered Bowls

These one-of-a-kind stainless steel bowls are great serving vessels for global cuisine and practically anything else.

- HB5** 16 oz. (473.2 mL)
5" Dia. x 2" H (12.7 x 5.1 cm)
- HB6** 27 oz. (798.5 mL)
6" Dia. x 2 1/2" H (15.2 x 6.4 cm)
- HB7** 38 oz. (1.1 L)
6 3/4" Dia. x 2 3/4" H (17.1 x 7 cm)



Shown with SPM4 S&P shakers



Squound Stainless Steel Bowls

Pair stainless steel with cutting-edge shapes, and you get some of the most contemporary serving bowls on the market.

- SB3** 40 oz. (1.2 L)
7" Dia. x 2 1/8" H (17.8 x 5.4 cm)
- SB5** 67 oz. (2 L)
9" Dia. x 2 3/4" H (22.9 x 7 cm)
- SB7** 126 oz. (3.7 L)
11" Dia. x 3" H (27.9 x 7.6 cm)

Squound Stainless Steel Snack Bowls

- SB325** 3 oz. (100 mL)
3 1/8" Dia. x 1 1/2" H (7.9 x 3.8 cm)
- SB400** 5 1/2 oz. (200 mL)
3 1/4" Dia. x 1 1/2" H (8.3 x 3.8 cm)
- SB450** 9 1/2 oz. (300 mL)
4 1/2" Dia. x 2 1/2" H (11.4 x 6.4 cm)
- SB575** 15 oz. (400 mL)
5 3/4" Dia. x 2 1/2" H (14.6 x 6.4 cm)





PWRB10

PWRB12



PWBB12

PWBB10

Rectangular Poplar Wood Boxes

Farm-to-table never looked so tempting. Use these boxes for baked goods, dry storage and produce for a hand-crafted aesthetic.

Natural

PWRB10 8 1/2" L x 5 3/4" W x 2 3/4" H
(21.6 x 14.6 x 7 cm)

PWRB12 12 3/8" L x 7 1/4" W x 2 3/4" H
(31.4 x 18.4 x 7 cm)

Black

PWBB10 8 1/2" L x 5 3/4" W x 2 3/4" H
(21.6 x 14.6 x 7 cm)

PWBB12 12 3/8" L x 7 1/4" W x 2 3/4" H
(31.4 x 18.4 x 7 cm)



Kraft Bags NEW

Paper bags that you can wash and reuse? It is now a reality with these innovative bread bags. Available in black and khaki colors with contrasting white stitching and foldable rims, each bag is machine washable for extended use.

Black

- KBB5** 5" Dia. x 4" H (12.7 x 10.2 cm)
- KBB7** 7" Dia. x 4" H (17.8 x 10.2 cm)
- KBB9** 9" Dia. x 10 3/8" H (22.9 x 26.4 cm)

Khaki

- KBK5** 5" Dia. x 4" H (12.7 x 10.2 cm)
- KBK7** 7" Dia. x 4" H (17.8 x 10.2 cm)
- KBK9** 9" Dia. x 10 3/8" H (22.9 x 26.4 cm)

Canvas Bags

These cream and gray canvas bags add a rustic feel to table settings. Pre-shrunk and machine-washable.

- TV3** 6 1/2" Dia. x 4 1/8" H (16.5 x 10.5 cm)
- TV4** 7 3/4" Dia. x 4 7/8" H (19.7 x 12.4 cm)
- TV6** 8" L x 6" W x 4" H (20.3 x 15.2 x 10.2 cm)
- TV8** 9 3/4" L x 7" W x 5" H (24.8 x 17.8 x 12.7 cm)
- TV9** 9" Dia. x 10 3/8" H (22.9 x 26.4 cm)

NEW

Canvas Pouch and Round Warming Stone

Heat up this terra cotta stone and insert into one of our canvas bags or pouches to cleverly and discreetly keep breads toasty.

- CWSP5** Canvas Pouch
5 1/2" Dia. (14 cm)
- TCWS5** Warming Stone
5 1/8" Dia. x 7/8" H (13 x 2.2 cm)

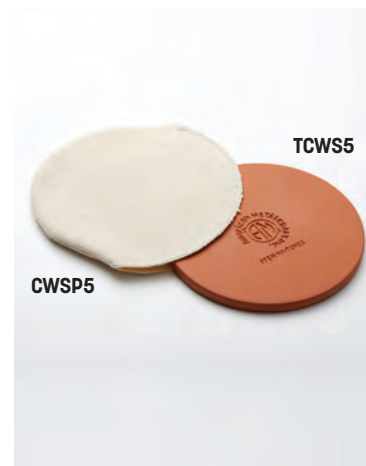



FBC92 shown with MRS300BL ramekins

FBS591 shown with MRS300BL ramekins

FFB59

Wrought Iron One-Cone Conical Baskets

- FFB59** One-Cone Basket
5" Dia. x 9" H (12.7 x 22.9 cm)
- FBS591** One-Cone Basket with One Ramekin Holder
(1) 3 oz. (88.7 mL) Ramekin included
5" Dia. x 9" H (12.7 x 22.9 cm)
- FBC92** One-Cone Basket with Two Ramekin Holders
(2) 3 oz. (88.7 mL) Ramekins included
5" Dia. x 9" H (12.7 x 22.9 cm)

Flat Coil Wrought Iron Conical Baskets

- FCD1** 5" Dia. x 6 ¾" H
(12.7 x 17.1 cm)
- FCD3** 8 ½" Dia. x 3 ¾" H
(21.6 x 9.5 cm)
- FCD2** 7" Dia. x 6" H
(17.8 x 15.2 cm)

Flat Coil Wrought Iron Slanted Conical Basket

- FWB4** 4 ½" Dia. x 7 ½" H
(11.4 x 19 cm)

Stainless Steel Conical Baskets

- SS59** One-Cone Basket
5" Dia. x 9" H (12.7 x 22.9 cm)
- SS92** One-Cone Basket with Two Ramekin Holders
(2) 3 oz. (88.7 mL) Ramekins included
5" Dia. x 9" H (12.7 x 22.9 cm)



FCD2

FCD3

FCD1



FWB4



SS92 shown with MRS300BL ramekins

SS59

Two-Tier Wrought Iron Basket

This seemingly hand-twisted basket would look as comfortable in an art museum as it will in your dining room.

TTDB2 Two-Tier Basket
13" Top Dia. x 15" Bottom Dia. x 19 5/8" H
(33 x 38.1 x 49.9 cm)

Square Fry Cone Holders and Cardboard Cones

SQFBSS Stainless Steel
2 1/2" Sq. Top x 3 5/8" Round Base x 5 1/4" H
(6.4 x 9.2 x 13.3 cm)

SQFBBL Black
2 1/2" Sq. Top x 3 5/8" Round Base x 5 1/4" H
(6.4 x 9.2 x 13.3 cm)

Square Cardboard Cones

SQFBCN10 10 oz. (295.7 mL)
4" Tapered Opening x 7 1/4" H
(10.2 x 18.4 cm)
Pack of 100

SQFBCN 15 oz. (443.6 mL)
4 3/4" Tapered Opening x 10 3/4" H
(12.1 x 27.3 cm)
Pack of 100

SQFBCN20 20 oz. (591.5 mL)
7 1/4" Tapered Opening x 12" H
(18.4 x 30.5 cm)
Pack of 100

Stainless Steel Conical Snack Holder

A smooth satin finish and sophisticated shape add a futuristic twist to this conical fry holder.

SSFC7 Standard
4 1/2" Dia. x 7" H (11.4 x 17.8 cm)

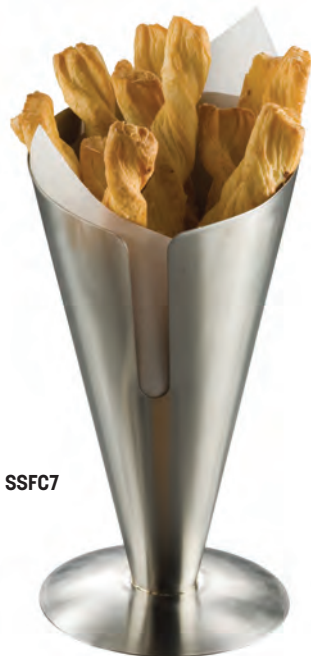

SSFC7



TTDB2



PREFOLDED
CONES FEATURE
A FOLDOUT
CONDIMENT
POCKET

SQFBSS
shown with
SQFBCN10 cone

SQFBSS
shown with
SQFBCN20 cone

SQFBBL shown
with SQFBCN cone



Mini Fry Baskets

Everyone loves the classic design and easy storage of our fry baskets. They're great for serving up any side, not just fried foods.

Black

FRYB433 Rectangular
4 1/8" L x 3 3/8" W x 3" H
with 4" Handle
(10.5 x 8.6 x 7.6, 10.2 cm)

FRYB443 Square
4" Sq. x 3" H
with 4" Handle
(10.2 x 7.6, 10.2 cm)

Stainless Steel

FRYT433 Rectangular
4 1/8" L x 3 3/8" W x 3" H
with 4" Handle
(10.5 x 8.6 x 7.6, 10.2 cm)

FRYS443 Square
4" Sq. x 3" H
with 4" Handle
(10.2 x 7.6, 10.2 cm)



Round Stainless Steel Fry Basket

FRYR375 Round
3 1/2" Dia. x 2 3/4" H
with 4" Handle
(8.9 x 7, 10.2 cm)





MSQBSKT

MFRYBSKT

Stainless Steel Fry Baskets

MSQBSKT Square
5" Sq. x 3" H
with 3 3/4" Handle
(12.7 x 7.6, 9.5 cm)

MFRYBSKT Rectangular
5" L x 4" W x 4" H
with 3 3/4" Handle
(12.7 x 10.2 x 10.2, 9.5 cm)

Mini Snack Baskets

Our popular fry baskets are now available without handles. In your choice of black or stainless steel.

Black

FBBR4 Rectangular
4 1/8" L x 3 3/8" W x 3" H
(10.5 x 8.6 x 7.6 cm)

FBBS44 Square
4" Sq. x 3" H
(10.2 x 7.6 cm)

Stainless Steel

FBSR43 Rectangular
4 1/8" L x 3 3/8" W x 3" H
(10.5 x 8.6 x 7.6 cm)

FBSS44 Square
4" Sq. x 3" H
(10.2 x 7.6 cm)



FBBR4

FBBS44



FBSS44

FBSR43



MRECBSKT shown with
PNS24 S&P shakers,
SSP35 pail and MBI
sauce cup

RMB59C



RMB95B shown with
FFC337 fry cup

SSRT962

Rectangular Fry Basket

MRECBSKT 9 1/2" L x 6" W x 1 1/2" H
with 4" Handle
(24.1 x 15.2 x 3.8, 10.2 cm)

Rectangular Grid Baskets

Small

RMB95B  Black
9" L x 6" W x 2 1/2" H
(22.9 x 15.2 x 6.4 cm)

RMB59C  Chrome
9" L x 6" W x 2 1/2" H
(22.9 x 15.2 x 6.4 cm)

SSRT962 Stainless Steel
9" L x 6" W x 2 1/2" H
(22.9 x 15.2 x 6.4 cm)

Large

GCRB2613  Black
13" L x 6" W x 2 1/2" H
(33 x 15.2 x 6.4 cm)

GCRC1362  Chrome
13" L x 6" W x 2 1/2" H
(33 x 15.2 x 6.4 cm)

GCSS6132 Stainless Steel
13" L x 6" W x 2 1/2" H
(33 x 15.2 x 6.4 cm)



GCRB2613

GCSS6132

GCRC1362 shown with
FRYR375 fry basket and
MRF350W ramekin



SQGS10 shown with
SSP35 mini pail and
MB1 sauce cup

SQGS6

SQGS8

SQGS12

Square Grid Baskets

The classic, squared. Our popular wire baskets now come in multiple square sizes. Think beyond the plate for burgers and fries, sandwiches or appetizers.

Stainless Steel

- SQGS6** 6" Sq. x 2" H
(15.2 x 5 cm)
- SQGS8** 8" Sq. x 2" H
(20.3 x 5 cm)
- SQGS10** 10" Sq. x 2" H
(25.4 x 5 cm)
- SQGS12** 12" Sq. x 2" H
(30.4 x 5 cm)

Black

- SQGB6** 6" Sq. x 2" H
(15.2 x 5 cm)
- SQGB8** 8" Sq. x 2" H
(20.3 x 5 cm)
- SQGB10** 10" Sq. x 2" H
(25.4 x 5 cm)
- SQGB12** 12" Sq. x 2" H
(30.4 x 5 cm)



SQGB10

SQGB12

SQGB8

SQGB6



WISS10

WISS8

WISS12 shown with SSFC7 cone



WIB100

WIB80

WIB120

Round Grid Baskets

In stainless steel or black, these grid-bottomed baskets can be dressed to look retro or futuristic.

Stainless Steel

WISS8 8" Dia. x 2" H
(20.3 x 5.1 cm)

WISS10 10" Dia. x 2" H
(25.4 x 5.1 cm)

WISS12 12" Dia. x 2" H
(30.5 x 5.1 cm)

Black

WIB80 8" Dia. x 2" H
(20.3 x 5.1 cm)

WIB100 10" Dia. x 2" H
(25.4 x 5.1 cm)

WIB120 12" Dia. x 2" H
(30.5 x 5.1 cm)



GOVB811 shown with PPRN2121 fry paper and HAMSC25 sauce cup

Oblong Grid Baskets

In your choice of black or stainless steel, these stylish baskets are perfect for serving casual entrées and appetizers with panache.

Black

GOVB69 9" L x 6" W x 2 1/2" H
(22.9 x 15.2 x 6.4 cm)

GOVB811 11" L x 8" W x 2 1/2" H
(27.9 x 20.3 x 6.4 cm)

Stainless Steel

GOVS69 9" L x 6" W x 2 1/2" H
(22.9 x 15.2 x 6.4 cm)

GOVS811 11" L x 8" W x 2 1/2" H
(27.9 x 20.3 x 6.4 cm)

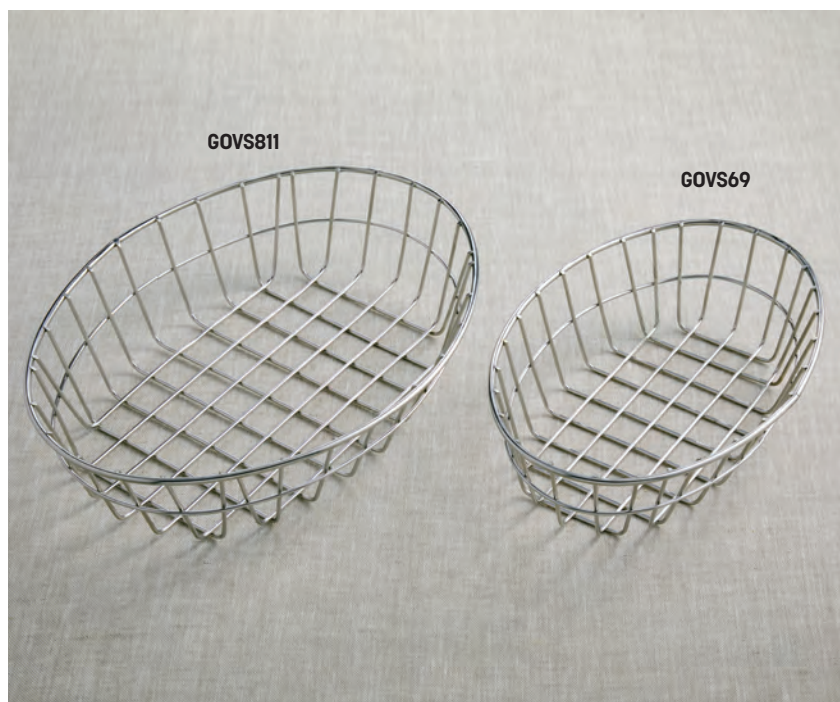



Zorro Baskets

Small

BZZ95B Black
9" L x 6" W x 2 1/2" H
(22.9 x 15.2 x 6.4 cm)

BZZ59C Chrome
9" L x 6" W x 2 1/2" H
(22.9 x 15.2 x 6.4 cm)

Large

ROB2613 Black
13" L x 6" W x 2 1/2" H
(33 x 15.2 x 6.4 cm)

ROC1362 Chrome
13" L x 6" W x 2 1/2" H
(33 x 15.2 x 6.4 cm)

Loop-D-Loop Baskets

Small

EBB59B Black
9" L x 6" W x 2 1/2" H
(22.9 x 15.2 x 6.4 cm)

EBB95C Chrome
9" L x 6" W x 2 1/2" H
(22.9 x 15.2 x 6.4 cm)

Large

LDLB2613 Black
13" L x 6" W x 2 1/2" H
(33 x 15.2 x 6.4 cm)

LDLC1362 Chrome
13" L x 6" W x 2 1/2" H
(33 x 15.2 x 6.4 cm)

IRONWORKS™ BASKETS

Whether you're serving breads, sandwiches or snacks, our Ironworks Collection twists hearty wrought iron and steel into artisanal showstoppers.

Oval Wrought Iron Bread Baskets

OSC9 Scroll, 6 ¾" L x 9" W
(17.1 x 22.9 cm)

OLB9 Leaf, 6 ¾" L x 9" W
(17.1 x 22.9 cm)

Round Wrought Iron Bread Baskets

BLLB81 Leaf, 8" Dia. x 3" H
(20.3 x 7.6 cm)

BLLB94 Leaf, 9" Dia. x 3 ⅝" H
(22.9 x 9.2 cm)

BLSB80 Scroll, 8" Dia. x 3" H
(20.3 x 7.6 cm)

BLSB93 Scroll, 9" Dia. x 3 ⅝" H
(22.9 x 9.2 cm)

Stainless Scroll Bread Baskets

SSLB83 Round, 8" Dia. x 3" H
(20.3 x 7.6 cm)

SSOC97 Oval, 6 ¾" L x 9" W x 3" H
(17.1 x 22.9 x 7.6 cm)

SSLB94 Round, 9" Dia. x 3 ⅞" H
(22.9 x 9.8 cm)

Rectangular Wrought Iron Scroll Baskets

SFBB5312 12" L x 5" W x 3" H
(30.5 x 12.7 x 7.6 cm)

SBBL13202 20" L x 13" W x 2" H
(50.8 x 33 x 5 cm)

Disposable Liner

PBSL3 Large PET Liner
19 ½" L x 12" W x 1 ½" H
(49.5 x 30.5 x 3.8 cm)

Wrought Iron Napkin Baskets

NDSL59 Leaf, 8 ¾" L x 5" W x 4 ½" H
(22.2 x 12.7 x 11.4 cm)

NDSS95 Scroll, 8 ¾" L x 5" W x 4 ½" H
(22.2 x 12.7 x 11.4 cm)





BNBC20132

BNBB13202

STACKABLE DESIGN FOR
EFFORTLESS STORAGE



FRUB9

FRUC7

Shown with PRSD3 sauce cup

BIRDNEST BASKETS

Our Birdnest Baskets feature a lightweight yet sturdy construction. Choose from a variety of shapes and styles in black or chrome.

Large Rectangular Baskets

BNBB13202 Black
20 1/2" L x 12 5/8" W x 1 3/4" H
(57.1 x 32.1 x 4.4 cm)

BNBC20132 Chrome
20 1/2" L x 12 5/8" W x 1 3/4" H
(57.1 x 32.1 x 4.4 cm)

Disposable Liner

PBSL3 PET Liner
19 1/2" L x 12" W x 1 1/2" H
(49.5 x 30.5 x 3.8 cm)

Round Baskets

FRUB9 Black, 7" Dia. x 5" H
(17.8 x 12.7 cm)

FRUC7 Chrome, 7" Dia. x 5" H
(17.8 x 12.7 cm)

Disposable Liner

WBCLINER PET Liner
for 7" Dia. baskets

Conical Baskets

BNB5 Black, 5" Dia. x 8 1/2" H
(12.7 x 21.6 cm)

BNB7 Black, 7" Dia. x 6" H
(17.8 x 15.2 cm)

BNB9 Black, 9" Dia. x 4" H
(22.9 x 10.2 cm)

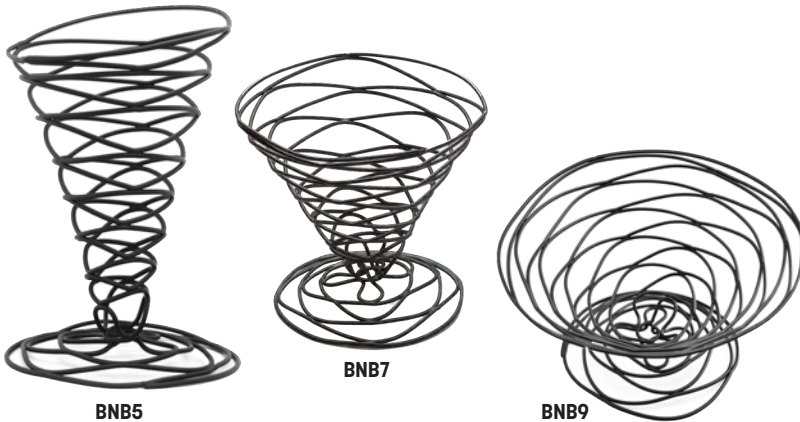

BNB5

BNB7

BNB9

Oval Baskets

FRUB18 Black, 9" L x 6" W x 3" H
(22.9 x 15.2 x 7.6 cm)

FRUC16 Chrome, 9" L x 6" W x 3" H
(22.9 x 15.2 x 7.6 cm)

Square Baskets/Risers

BNRB64B Black, 6" Sq. Top
x 4" Sq. Bottom x 4" H
(15.2 x 10.2 x 10.2 cm)

BNRB86B Black, 8" Sq. Top
x 6" Sq. Bottom x 4" H
(20.3 x 15.2 x 10.2 cm)

BNRB46C Chrome, 6" Sq. Top
x 4" Sq. Bottom x 4" H
(15.2 x 10.2 x 10.2 cm)

BNRB68C Chrome, 8" Sq. Top
x 6" Sq. Bottom x 4" H
(20.3 x 15.2 x 10.2 cm)





BSKB80 shown with
MRS200BL ramekin

BSKC08



BSKB96

BSKC69 shown with
MRS200W ramekins

Round Wire Baskets with Ramekin Holders

BSKB80 Black
8" Dia. x 3 3/4" H
(20.3 x 9.5 cm)

BSKC08 Chrome
8" Dia. x 3 3/4" H
(20.3 x 9.5 cm)

Oblong Wire Baskets with Ramekin Holders

BSKB96 Black
9" L x 6" W x 4" H
(22.9 x 15.2 x 10.2 cm)

BSKC69 Chrome
9" L x 6" W x 4" H
(22.9 x 15.2 x 10.2 cm)

HOT



BSKB811 shown with
MRS200BL ramekins

BSKC118

Oval Wire Baskets with Ramekin Holders-Mesh Bottom HOT 🍳

With stylishly retro curves and your choice of finish, these durable baskets are great for sandwich and entrée service.

BSKB811 Black
11" L x 8" W x 3 1/4" H
(27.9 x 20.3 x 8.3 cm)

BSKC118 Chrome
11" L x 8" W x 3 1/4" H
(27.9 x 20.3 x 8.3 cm)

Smooth Ramekins

MRS200W White, 2 oz. (59.1 mL)

MRS200BL Black, 2 oz. (59.1 mL)

Fluted Ramekins

MRF250W White, 2 oz. (59.1 mL)

MRF250BL Black, 2 oz. (59.1 mL)

Onion Ring Spindles 🍳

Take your onion ring and bagel presentation to new heights with these stainless steel spindles. Fits round and oval baskets (sold separately).

ORHC1 Round Base
5 1/4" Dia. x 9" H
(13.3 x 22.9 cm)

ORH02 Oval Base
6 1/4" L x 4" W x 9" H
(15.9 x 10.2 x 22.9 cm)



ORHC1 shown with
BSKC08 basket and
MRF250BL ramekins

ORH02 shown with
BSKC69 basket and
MRF250BL ramekins





WBBR80 shown with
RGJ4 glass jar and
PPCH4N natural paper

WBBV90

Black Wire Baskets

These essential baskets set the stage for entrées and appetizers alike. Elegant, sleek and absolutely eye-catching.

WBBV90 Oval
9" L x 6" W x 2 ¾" H
(22.9 x 15.2 x 7 cm)

WBBR80 Round
8" Dia. x 2 ¾" H
(20.3 x 7 cm)

Bronze Wire Baskets

A beautiful bronze finish on an attractive wire design, perfect for presenting rolls, breads and biscuits.

Round

WBBS 5" Dia. x 3 ⅛" H
(12.7 x 7.9 cm)

WBBM 7" Dia. x 4 ¼" H
(17.8 x 10.8 cm)

Oval

WBB9 9" L x 6" W x 2 ¼" H
(22.9 x 15.2 x 5.7 cm)

WBB11 11" L x 8" W x 2 ½" H
(27.9 x 20.3 x 6.4 cm)



WBBM shown with
PPCH2N natural paper

WBBS



WBB11

WBB9

Black Mesh Bottom Baskets

These simple, functional wrought iron baskets come in your choice of size and design.

- SSB28** Straight-Sided Round
8" Dia. x 2 ½" H
(20.3 x 6.4 cm)
- SSB96** Straight-Sided Oval
9" L x 6" W x 2 ½" H
(22.9 x 15.2 x 6.4 cm)
- WSB82** Wavy-Sided Round
8" Dia. x 2 ½" H
(20.3 x 6.4 cm)
- WSB69** Wavy-Sided Oval
9" L x 6" W x 2 ½" H
(22.9 x 15.2 x 6.4 cm)

Chix Wire Baskets

In black or chrome, these rustic baskets bring homey authenticity to your presentation.

- WIR4** Black Oval
9 ½" L x 6 ½" W x 2 ½" H
(24.1 x 16.5 x 6.4 cm)
- WIR3** Chrome Oval
9 ½" L x 6 ½" W x 2 ½" H
(24.1 x 16.5 x 6.4 cm)

Go-Go Baskets

- WCW69** Silver Oval
9" L x 6" W x 3" H
(22.9 x 15.2 x 7.6 cm)
- WCW81** Silver Round
8" Dia. x 2 ⅞" H
(20.3 x 7.3 cm)
- WBW96** Black Oval
9" L x 6" W x 3" H
(22.9 x 15.2 x 7.6 cm)
- WBW80** Black Round
8" Dia. x 2 ⅞" H
(20.3 x 7.3 cm)

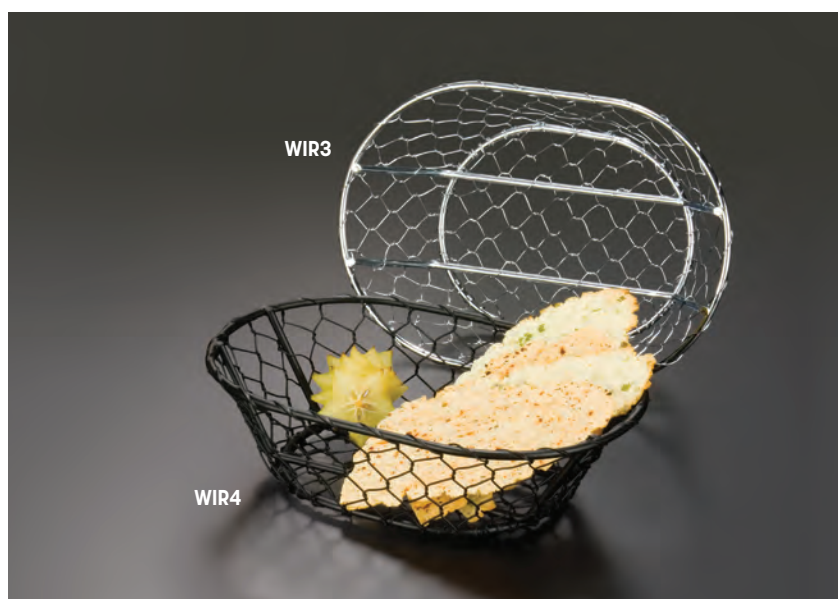



Stainless Steel Baskets

Available in oval and round shapes and three different sizes.

Oval

OBS58 7 7/8" L x 5 5/8" W x 3" H
(20 x 14.3 x 7.6 cm)

OBS69 9 1/8" L x 7" W x 3" H
(23.2 x 17.8 x 7.6 cm)

OBS913 13 3/8" L x 9 3/8" W x 4 1/2" H
(34 x 23.8 x 11.4 cm)

Round

BSS7 6 5/8" Dia. x 2 3/4" H
(16.8 x 7 cm)

BSS8 8" Dia. x 2 7/8" H
(20.3 x 7.3 cm)

BSS11 11" Dia. x 4 1/4" H
(27.9 x 11 cm)

Whirly Baskets/Risers

Versatility and eye-catching elegance are the calling cards of these stainless steel creations. Use them as baskets, or flip them over for stunning pedestal displays.

FR8 8" Dia. x 5" H
(20.3 x 12.7 cm)

FR12 12" Dia. x 6" H
(30.5 x 15.2 cm)



Space/Time Continuum Chrome Baskets

Retro-futurism is timeless, and these chic baskets are proof.

SCB480 Square Web
8 ¼" Sq. x 4 ½" H (21 x 11.4 cm)

BAS1 Checker
8" Sq. x 2 ¾" H (20.3 x 7 cm)

Round Wire Baskets

Available in chrome or black wire. A plastic liner is also available.

BWB750 Black
7" Dia. x 5" H (17.8 x 13 cm)

WBC705 Chrome
7" Dia. x 5" H (17.8 x 13 cm)



Disposable Liner

WBCLINER PET Liner for 7" Dia. Baskets (not shown)

Round Thatch Baskets

These unique baskets are ideal for serving baked goods in an intimate setting, or even for a memorable sandwich presentation.

FRUB12 Black
8" Dia. x 3 ⅝" H (20.3 x 9.2 cm)

FRUC10 Chrome
8" Dia. x 3 ⅝" H (20.3 x 9.2 cm)

FRU11 Brushed Copper
8" Dia. x 3 ⅝" H (20.3 x 9.2 cm)



CRL86 shown with BHM2 S&P shakers and BEE606 shaker



FLAT-BACK DESIGN FOR PLACEMENT AGAINST A WALL



Semi-Round Wrought Iron Condiment Racks

- CRL86** Leaf
8 ¼" L x 6 ¼" W x 9" H
(21 x 15.9 x 22.9 cm)
- CRS68** Scroll
8 ¼" L x 6 ¼" W x 9" H
(21 x 15.9 x 22.9 cm)

Wrought Iron Condiment Racks

Leaf Design

- LDCC16** 6 ¼" Dia. x 9" H (15.9 x 22.9 cm)
- LDCC17** 7 ½" Dia. x 9" H (19.1 x 22.9 cm)
- LDCC18** 7 ¾" Dia. x 9" H (19.7 x 22.9 cm)

Scroll Design

- WBCC6** 6 ¼" Dia. x 9" H (15.9 x 22.9 cm)
- WBCC7** 7 ½" Dia. x 9" H (19.1 x 22.9 cm)
- WBCC8** 7 ¾" Dia. x 9" H (19.7 x 22.9 cm)

Stainless Steel Condiment Racks with Scroll Design

- SSCC6** 6 ¼" Dia. x 9" H (15.9 x 22.9 cm)
- SSCC7** 7 ½" Dia. x 9" H (19.1 x 22.9 cm)
- SSCC8** 7 ¾" Dia. x 9" H (19.7 x 22.9 cm)



Flat Coil Wrought Iron Condiment Racks HOT  

- FWC69** 6" Dia. x 9 1/2" H
(15.2 x 24.1 cm)
- FWC89** 7 7/8" Dia. x 9 1/8" H
(20 x 23.2 cm)
- FWC68** 8" L x 5 7/8" W x 9 1/4" H
(20.3 x 14.9 x 23.5 cm)

Birdnest Semi-Round Condiment Racks  

- SRBNB1** Black
5 5/8" L x 8" W x 9 1/8" H
(14.3 x 20.3 x 23.2 cm)
- SRBNC2** Chrome
5 5/8" L x 8" W x 9 1/8" H
(14.3 x 20.3 x 23.2 cm)

Birdnest Condiment Racks  

- Small**
- RBNB16** Black
6" Dia. x 9 1/8" H
(15.2 x 23.2 cm)
 - RBNC26** Chrome
6" Dia. x 9 1/8" H
(15.2 x 23.2 cm)

- Large**
- RBNB17** Black
7 3/4" Dia. x 9 1/8" H
(19.7 x 23.2 cm)
 - RBNC27** Chrome
7 3/4" Dia. x 9 1/8" H
(19.7 x 23.2 cm)



FWC68 shown with BHM2 S&P shakers

FWC89 shown with 3309 shaker

FWC69



SRBNC2

SRBNB1



RBNC26

RBNB16



RBNB17 shown with BEE319 shaker and PNS13 S&P shakers

RBNC27



CSM2 shown with
OWP13 olive wood peel

CSM3

CSM40 shown with 4406
and GLADT6 shakers



SCH7

SCH6

SCH8



SCHB8

SCHB7

SCHB6

Jumbo Stainless Steel Soup Cans

Whether you use them as risers or condiment holders, these rustic cans offer versatile solutions with a memorable twist.

CSM40 40 oz. (1.2 L)
6 ¼" Dia. x 3" H (15.9 x 7.6 cm)

CSM2 2 qt. (1.8 L)
5 ½" Dia. x 6" H (13.3 x 15.2 cm)

CSM3 3 ¼ qt. (3.1 L)
6 ¼" Dia. x 7" H (15.9 x 17.8 cm)

Contemporary Condiment Racks

These brushed stainless steel and black condiment holders feature a laser-cut design for a modern, upscale look.

Stainless Steel

SCH6 6 ¼" Dia. x 9 ¼" H
(15.9 x 23.5 cm)

SCH7 7 ¾" Dia. x 9 ½" H
(19.7 x 24.1 cm)

SCH8 8" L x 5 ⅞" W x 9 ½" H
(20.3 x 14.9 x 24.1 cm)

Black

SCHB6 6 ¼" Dia x 9 ¼" H
(15.9 x 23.5 cm)

SCHB7 7 ¾" Dia x 9 ½" H
(19.7 x 24.1 cm)

SCHB8 8" L x 5 ⅞" W x 9 ½" H
(20.3 x 14.9 x 24.1 cm)

Salt & Pepper Racks

In black or chrome, each rack features a slot on top to hold order numbers or menus.

WSPR2B Black
5 3/4" L x 2 1/4" W x 12" H
(14.6 x 6.4 x 30.5 cm)

WSPR3C Chrome
5 3/4" L x 2 1/4" W x 12" H
(14.6 x 6.4 x 30.5 cm)

Rectangular Shopping Baskets

Ditch the empty six-pack, and keep condiments and napkins handy with these charming double-handled baskets.

RBHB975 Black
9" L x 7" W x 5" H
(22.9 x 17.8 x 12.7 cm)

RBHC759 Chrome
9" L x 7" W x 5" H
(22.9 x 17.8 x 12.7 cm)

Rectangular Condiment Racks

Though we designed them for condiments, these racks double as stages for sandwiches.

BWC9 9" L x 6" W x 3 1/2" H
(22.9 x 15.2 x 8.9 cm)

BWC12 12 3/4" L x 4 3/8" W x 3 1/2" H
(32.4 x 11.1 x 8.9 cm)

Galvanized Condiment Caddy

We made these metallic caddies extra deep to make topper-proof transport a cinch.

MTUB7 7" L x 5 3/4" W x 4" H
(17.8 x 14.6 x 10.2 cm)





GC36

GC34



GCH28

GSC2

GCD28

GSB2

GSF2

Glass Carafes

These elegantly curved carafes are a stylish addition to any brunch or dinner service.

GC36 36 oz., 34 oz. to Shoulder (1.1 L, 1 L)
4" Dia. x 9 1/2" H (10.2 x 24.1 cm)

GC34 34 oz., 16 oz. to Shoulder (1 L, 473.2 mL)
4" Dia. x 9 1/2" H (10.2 x 24.1 cm)

Glass Water Bottles and Stoppers

In-house water filtration is in, and these elegant pieces are the perfect accompaniment to the trend. Mix and match two styles of carafes and three styles of stoppers to elevate your H₂O. Stopper sold separately.

Glass Water Bottles

GCD28 Diamond
29 oz., 28 oz. to Shoulder (0.9 L, 0.8 L)
3 1/8" Dia. x 10 1/4" H (7.9 x 26 cm)

GCH28 Pebbled
29 oz., 28 oz. to Shoulder (0.9 L, 0.8 L)
3 1/8" Dia. x 10 1/4" H (7.9 x 26 cm)

Glass Bottle Stoppers

GSB2 Blue Marble
1 3/4" Dia. x 2 3/4" H (4.4 x 7 cm)

GSC2 Clear
1 3/4" Dia. x 2 3/4" H (4.4 x 7 cm)

GSF2 Frosted
1 3/4" Dia. x 2 3/4" H (4.4 x 7 cm)



Hinged Acrylic Water Bottles

Our original take on a popular style, these gasketed bottles are designed to keep out contaminants.

- WBC34** Clear, 34 oz. (1 L)
4 1/8" Dia. x 11 5/8" H (10.5 x 29.5 cm)
- WBC36** Clear, 36 oz. (1.1 L)
3 3/8" Dia. x 11 1/8" H (8.6 x 28.3 cm)

Clear Acrylic Water Bottles

In a quartet of distinct styles, these one-liter acrylic bottles make even simple beverages photogenic. Cap included.

- WB32** Clear, 34 oz. (1 L)
3 1/2" Dia. x 11 1/4" H (8.9 x 28.6 cm)
- WB33** Fluted, 34 oz. (1 L)
3 1/2" Dia. x 11 1/4" H (8.9 x 28.6 cm)
- WB34** Pebbled, 34 oz. (1 L)
3 1/2" Dia. x 11 1/4" H (8.9 x 28.6 cm)
- WB35** Diamond, 34 oz. (1 L)
3 1/2" Dia. x 11 1/4" H (8.9 x 28.6 cm)
- WBCAP** Replacement Cap
1 5/8" Dia. x 1" H (4.1 x 2.5 cm)



TURN CLEAR ACRYLIC WATER BOTTLES INTO A JUMBO MIXER BOTTLE WITH A STAINLESS STEEL POURER ON PG. 332





Pebbled Acrylic Water Bottle

Inspired by our pebbled glass water bottle, this piece is made from plastic for extra durability. Cap included.

WBP34 Clear, 34 oz. (1 L)
3 7/8" Dia. x 11 5/8" H (8.9 x 29.5 cm)

WBPCAP Replacement Cap
2 1/4" Dia. x 5/8" H (5.7 x 1.6 cm)

Clear Acrylic Water Carafes with Cup

Durable and designed with ease in mind, these cup-carafe combos are crafted for daily use.

WC40 Round Carafe with Cup
40 oz. (1.2 L)
3 1/2" Dia. x 10" H (8.9 x 25.4 cm)

Replacement Cup

WCC1 Plastic Cup for WC40
18 oz. (532.3 mL)
3 1/2" Dia. x 3 3/4" H (8.9 x 9.5 cm)



Freshly Squeezed

WC40

CUP AND CARAFE FIT TOGETHER FOR EASY TRANSPORT AND STORAGE



Bell Pitchers

Available in stainless steel mirror finish.

Stainless Steel

- WP68** 68 oz. (2 L)
5" Dia. x 8 1/4" H
8 1/4" W with Handle
(12.7 x 21, 21 cm)
- WP100** 100 oz. (3 L)
5 1/4" Dia. x 9" H
9 3/4" W with Handle
(13.3 x 22.9, 24.8 cm)
- BPG67** 68 oz. (2 L)
5" Dia. x 8 1/2" H
8 1/4" W with Handle
(12.7 x 21.6, 21 cm)
with Ice Guard
- BPG101** 100 oz. (3 L)
5" Dia. x 9 1/4" H
9 3/4" W with Handle
(12.7 x 23.5, 24.8 cm)
with Ice Guard





Long Neck Bell Pitchers

Available in a hammered or brushed stainless steel finish.

Single-Wall

BWP84 Satin Finish
84 oz. (2.5 L)
5" Dia. x 9 1/4" H, 8 3/4" W with Handle
(12.7 x 23.5, 22.2 cm)
(Not Shown, Includes Ice Guard)

BWPH84 Hammered Finish
84 oz. (2.5 L)
5" Dia. x 9 1/4" H, 8 3/4" W with Handle
(12.7 x 23.5, 22.2 cm)
(Not Shown, Includes Ice Guard)

Double-Wall

SDWP64 Satin Finish
64 oz. (1.9 L)
5" Dia. x 10 3/4" H, 8 3/4" W with Handle
(12.7 x 27.3, 22.2 cm)

DWPH64 Hammered Finish
64 oz. (1.9 L)
5" Dia. x 10 3/4" H, 8 3/4" W with Handle
(12.7 x 27.3, 22.2 cm)

Gold Long Neck Bell Pitchers

Featuring beautiful hammered and satin finishes, these gold pitchers are très fashionable.

Single-Wall

BWPG84 Satin Finish
84 oz. (2.5 L)
5" Dia. x 9 1/4" H, 8 3/4" W with Handle
(12.7 x 23.5, 22.2 cm)

BWPHG84 Hammered Finish
84 oz. (2.5 L)
5" Dia. x 9 1/4" H, 8 3/4" W with Handle
(12.7 x 23.5, 22.2 cm)





Double-Wall Bell Pitchers

These double-walled pitchers are cleverly crafted to reduce condensation and drippage.

Mirror Finish

DWP44 44 oz. (1.3 L)
4 ½" Dia. x 8 ⅛" H, 8 ½" W with Handle
(11.4 x 20.6, 21.6 cm)

DWP64 64 oz. (1.9 L)
5" Dia. x 9" H, 10" W with Handle
(12.7 x 22.9, 25.4 cm)
(not shown)

Hammered Finish

HMWP44 44 oz. (1.3 L)
4 ½" Dia. x 8 ⅛" H, 8 ½" W with Handle
(11.4 x 20.6, 21.6 cm)

HMWP64 64 oz. (1.9 L)
5" Dia. x 9" H, 10" W with Handle
(12.7 x 22.9, 25.4 cm)
(not shown)

Satin Finish

DWPS44 44 oz. (1.3 L)
4 ½" Dia. x 8 ⅛" H, 8 ½" W with Handle
(11.4 x 20.6, 21.6 cm)

DWPS64 64 oz. (1.9 L)
5" Dia. x 9" H, 10" W with Handle
(12.7 x 22.9, 25.4 cm)
(not shown)



Hammered Bell Water Pitchers

Add a touch of artistry to your cold beverage service with these hammered stainless steel pitchers. Perfect for water, iced tea or lemonade.

HMWP85 68 oz. (2 L)
5" Dia. x 8 ¼" H, 8 ¼" W with Handle
(12.7 x 21, 21 cm)

HMWP97 100 oz. (3 L)
6" Dia. x 9" H, 9 ¾" W with Handle
(15.2 x 22.9, 24.8 cm)



OWPIT54

OWPIT30

Angled Water Pitchers

Stylishly sleek, these satin-finished stainless steel pitchers are simple, elegant and practical.

OWPIT30 30 oz. (887.2 mL)
5 ¼" Dia. x 9 ¾" H, 7" W with Handle
(13.3 x 23.8, 17.8 cm)

OWPIT54 54 oz. (1.6 L)
4 ½" Dia. x 11" H, 6 ¼" W with Handle
(11.4 x 27.9, 15.9 cm)

Double-Wall Pitcher with Lid

Durable stainless steel pitcher features double-wall styling and hinged lid.

DWCP48 52 oz. (1.5 L)
4 ½" Dia. x 9" H, 6 ¼" W with Handle
(10.8 x 22.9, 15.9 cm)



HINGED LID

DWCP48

Contemporary Pitchers HOT

Our most modern pitchers, these stainless steel pieces feature slim design and ice guards for a brilliant blend of functionality and style.

- WPSF33** 33 oz. (1 L)
3 1/8" Dia. x 8 7/8" H, 5 3/8" W with Handle
(7.9 x 22.5, 13.7 cm)
- WPSF67** 67 oz. (2 L)
4 1/2" Dia. x 9 1/4" H, 6 3/4" W with Handle
(11.4 x 23.5, 17.1 cm)

Elegance™ Double-Wall Beverage Service

Style via consistency. This five-piece stainless steel line includes coffee pots in two sizes, a water pitcher, a sugar bowl and a creamer.

- DWS5** Sugar Bowl, 5 oz. (147.9 mL)
3 1/4" Dia. x 3" H (8.3 x 7.6 cm)
- DWC5** Creamer, 5 oz. (147.9 mL)
3 1/2" L x 2" W x 5" H (8.9 x 5.1 x 12.7 cm)
- DWCP16** Coffee Pot, 16 oz. (473.2 mL)
3" L x 5 1/4" W x 7 1/4" H (7.6 x 13.3 x 18.4 cm)
- DWWP50** Water Pitcher, 50 oz. (1.5 L)
4 3/8" L x 7" W x 8" H (11.1 x 17.8 x 20.3 cm)
- DWCP50** Coffee Pot, 50 oz. (1.5 L)
4 3/8" L x 7" W x 10" H (11.1 x 17.8 x 25.4 cm)

WPSF67

WPSF33

HOT

DWWP50

DWCP50

DWS5

DWC5

DWCP16



Porcelain Creamers

These simple, round creamers bring a friendly touch to coffee service.

PCR25 2 ½ oz. (73.9 mL)
2 ½" L x 3 ¼" W x 2 ¾" H
(6.4 x 8.3 x 6 cm)

PCR55 5 ½ oz. (162.7 mL)
3" L x 4 ¾" W x 3" H
(7.6 x 11.1 x 7.6 cm)

Porcelain Bell Creamers

A quintessential design that's sure to invoke nostalgia.

PBC25 2 oz. (59.1 mL)
2 ½" L x 3" W x 3" H
(5.4 x 7.6 x 7.6 cm)

PBC45 4 oz. (118.3 mL)
3 ¼" L x 2 ¼" W x 3 ¼" H
(8.3 x 5.7 x 8.3 cm)

Ceramic Milk Carton Creamer

A surprising spin on a cafeteria classic, this design is a customer favorite.

CMCC5 5 oz. (147.9 mL)
2 ½" L x 4 ½" W x 3 ¼" H
(5.4 x 10.5 x 8.3 cm)

Black Artisanal Porcelain

With a rustic two-tone glazed finish, our black collection brings a handcrafted look to coffee and dinner service alike.

Bell Creamers

PBBL2 2 ½ oz. (73.9 mL)
2 ½" L x 3 ¼" W x 2 ¾" H
(6.3 x 8.3 x 6 cm)

PBBL4 4 oz. (118.3 mL)
3 ¼" L x 2 ¼" W x 2 ¼" H
(8.3 x 5.7 x 5.7 cm)

Bowl and Sugar Packet Holder

PBL7 Bowl, 7 oz. (207 mL)
3 ⅞" Dia. x 2 ¼" H (9.8 x 5.7 cm)

PSBL Sugar Packet Holder, 5 oz. (147.9 mL)
3 ½" L x 2 ½" W x 2" H
(8.9 x 6.3 x 5.1 cm)





Evolution™ Creamers

Silver

- SCM3** 2 ½ oz. (73.9 mL)
2" Dia. x 2" H (5.1 x 5.1 cm)
- SCM4** 4 ½ oz. (133.1 mL)
2" Dia. x 3 ½" H (5.1 x 8.9 cm)
- SCM6** 6 oz. (177.4 mL)
2" Dia. x 4 ¾" H (5.1 x 12.1 cm)

Black

- SCMB3** 2 ½ oz. (73.9 mL)
2" Dia. x 2" H (5.1 x 5.1 cm)
- SCMB4** 4 ½ oz. (133.1 mL)
2" Dia. x 3 ½" H (5.1 x 8.9 cm)
- SCMB6** 6 oz. (177.4 mL)
2" Dia. x 4 ¾" H (5.1 x 12.1 cm)

Gold

- SCMG3** 2 ½ oz. (73.9 mL)
2" Dia. x 2" H (5.1 x 5.1 cm)
- SCMG4** 4 ½ oz. (133.1 mL)
2" Dia. x 3 ½" H (5.1 x 8.9 cm)
- SCMG6** 6 oz. (177.4 mL)
2" Dia. x 4 ¾" H (5.1 x 12.1 cm)

Milk Carton Creamers

Silver

- MCC300** 3 oz. (88.7 mL)
2 ¾" L x 2" W x 2 ¼" H (7 x 5.1 x 5.7 cm)
- MCC500** 5 oz. (147.9 mL)
2 ¾" L x 2" W x 3" H (7 x 5.1 x 7.6 cm)

Gold

- MCG300** 3 oz. (88.7 mL)
2 ¾" L x 2" W x 2 ¼" H (7 x 5.1 x 5.7 cm)
- MCG500** 5 oz. (147.9 mL)
2 ¾" L x 2" W x 3" H (7 x 5.1 x 7.6 cm)

Black

- MCB300** 3 oz. (88.7 mL)
2 ¾" L x 2" W x 2 ¼" H (7 x 5.1 x 5.7 cm)
- MCB500** 5 oz. (147.9 mL)
2 ¾" L x 2" W x 3" H (7 x 5.1 x 7.6 cm)





HOT

SSPT5

SSBV1

Shown with
ST10 stainless steel tray

MCC500

SSPH2

SCM2

SSPT3

SSPH4

SSPT3



HOT

RSSPH2

SQSSPH2

SSPT3

RTSSPH3

**Satin Finish Stainless Coffee/
Tabletop Accessories** HOT

Straight-Sided Sugar Packet/Cube Holders

- SSPH2 2" Dia. x 2 3/4" H (5.1 x 7 cm)
- SSPT5 2" Sq. x 2 3/4" H (5.1 x 7 cm)
- SSPH4 3 1/4" L x 2 3/4" W x 1 3/4" H (8.3 x 7 x 4.4 cm)

Angled Sugar Packet/Cube Holders

- RSSPH2 2" Dia. x 2 3/4" H (5.1 x 7 cm)
- SQSSPH2 2" Sq. x 2 3/4" H (5.1 x 7 cm)
- RTSSPH3 3 1/8" L x 2 1/2" W x 1 3/4" H (7.9 x 6.4 x 4.4 cm)

Tray

- SSPT3 4 1/4" L x 2 1/4" W x 1" H (10.8 x 5.7 x 2.5 cm)

Bud Vase

- SSBV1 1 3/4" Sq. x 5 1/4" H (4.4 x 13.3 cm)

Creamers

- SCM2 4 oz. (118.3 mL)
2" Dia. x 2 3/4" H (5.1 x 7 cm)
- MCC500 5 oz. (147.9 mL)
2 3/4" L x 2" W x 3" H (7 x 5.1 x 7.6 cm)



**Hammered Finish Stainless Coffee/
Tabletop Accessories**

Angled Sugar Packet/Cube Holders

HMSRSPH2 2" Dia. x 2 3/4" H (5.1 x 7 cm)

HMSSQPH2 2" Sq. x 2 3/4" H (5.1 x 7 cm)

HMSRSPH3 3 1/8" L x 2 1/2" W x 1 3/4" H (7.9 x 6.6 x 4.5 cm)

Straight-Sided Sugar Packet/Cube Holders

HMSPH2 2" Dia. x 2 3/4" H (5.1 x 7 cm)

HMSPT5 2" Sq. x 2 3/4" H (5.1 x 7 cm)

HMSPH4 3 1/4" L x 2 3/4" W x 1 3/4" H (8.3 x 7 x 4.4 cm)

Tray

HMSPT3 4 1/4" L x 2 1/4" W x 1" H (10.8 x 5.7 x 2.5 cm)

Bud Vase

HMBV1 1 3/4" Sq. x 5 1/4" H (4.4 x 13.3 cm)

Creamer

HMCM2 4 oz. (118.3 mL)
2" Dia. x 2 3/4" H (5.1 x 7 cm)





Stainless Steel Coffee Accessories

Contemporary, luxe and undeniably striking, this collection of tabletop accessories draws attention with cosmopolitan flair.

Black

- BSPH2** Cylinder
2" Dia. x 2 ¾" H
(5.1 x 7 cm)
- BPT3** Tray
4 ¼" L x 2 ¼" W x 1" H
(10.8 x 5.7 x 2.5 cm)
- BSPT5** Square
2" Sq. x 2 ¾" H
(5.1 x 7 cm)
- BCM2** Creamer
4 oz. (118.3 mL)
2" Dia. x 2 ¾" H
(5.1 x 5.1 x 7 cm)
- BSPH4** Rectangular
3 ¼" L x 2 ¾" W x 1 ¾" H
(8.3 x 7 x 4.4 cm)

Gold

- GSPH2** Cylinder
2" Dia. x 2 ¾" H
(5.1 x 7 cm)
- GPT3** Tray
4 ¼" L x 2 ¼" W x 1" H
(10.8 x 5.7 x 2.5 cm)
- GSPT5** Square
2" Sq. x 2 ¾" H
(5.1 x 7 cm)
- GCM2** Creamer
4 oz. (118.3 mL)
2" Dia. x 2 ¾" H
(5.1 x 7 cm)
- GSPH4** Rectangular
3 ¼" L x 2 ¾" W x 1 ¾" H
(8.3 x 7 x 4.4 cm)



Hammered Bell Creamers

Just try and resist these adorable creamers in copper, gold or natural stainless steel. Your customers will be charmed by their sleek hammered design and petite frame.

Copper

- CHC2** 2 oz. (59.1 mL)
2 ¼" L x 2" W x 2 ¼" H
(5.7 x 5.1 x 5.7 cm)
- CHC4** 4 oz. (118.3 mL)
3" L x 2 ¼" W x 2 ¾" H
(7.6 x 5.7 x 7 cm)

Gold

- CHG2** 2 oz. (59.1 mL)
2 ¼" L x 2" W x 2 ¼" H
(5.7 x 5.1 x 5.7 cm)
- CHG4** 4 oz. (118.3 mL)
3" L x 2 ¼" W x 2 ¾" H
(7.6 x 5.7 x 7 cm)

Silver

- CHS2** 2 oz. (59.1 mL)
2 ¼" L x 2" W x 2 ¼" H
(5.7 x 5.1 x 5.7 cm)
- CHS4** 4 oz. (118.3 mL),
3" L x 2 ¼" W x 2 ¾" H
(7.6 x 5.7 x 7 cm)



Hammered Aluminum Sugar Packet Holders

In your choice of super sleek colors, these aluminum sugar packet holders are sure to sweeten your coffee and tea presentation.

- ASPC** Copper, 6 oz. (177.4 mL)
3 ⅜" L x 2 ⅜" W x 2" H
(8.6 x 6 x 5.1 cm)
- ASPB** Black, 6 oz. (177.4 mL)
3 ⅜" L x 2 ⅜" W x 2" H
(8.6 x 6 x 5.1 cm)
- ASPS** Silver, 6 oz. (177.4 mL)
3 ⅜" L x 2 ⅜" W x 2" H
(8.6 x 6 x 5.1 cm)
- ASPG** Gold, 6 oz. (177.4 mL)
3 ⅜" L x 2 ⅜" W x 2" H
(8.6 x 6 x 5.1 cm)



SPC2

SPC3

Stainless Steel Sugar Packet Milk Crates

- SPC2** Cylinder
2" Dia. x 2 3/4" H
(5.1 x 6.9 cm)
- SPC3** Rectangular
3 1/2" L x 2 1/2" W x 1 1/2" H
(8.9 x 6.4 x 3.8 cm)

Stainless Steel Sugar Packet Crates

- SPC** Satin
3 1/2" L x 2 1/2" W x 1 1/2" H
(8.9 x 6.4 x 3.8 cm)
- SPH** Hammered
3 1/2" L x 2 1/2" W x 1 1/2" H
(8.9 x 6.4 x 3.8 cm)

Galvanized Sugar Packet Holders

- GSP35** 5" L x 3" W x 2" H
(12.7 x 7.6 x 5.1 cm)
- DGSP35** 5" L x 3" W x 2" H
(12.7 x 7.6 x 5.1 cm)

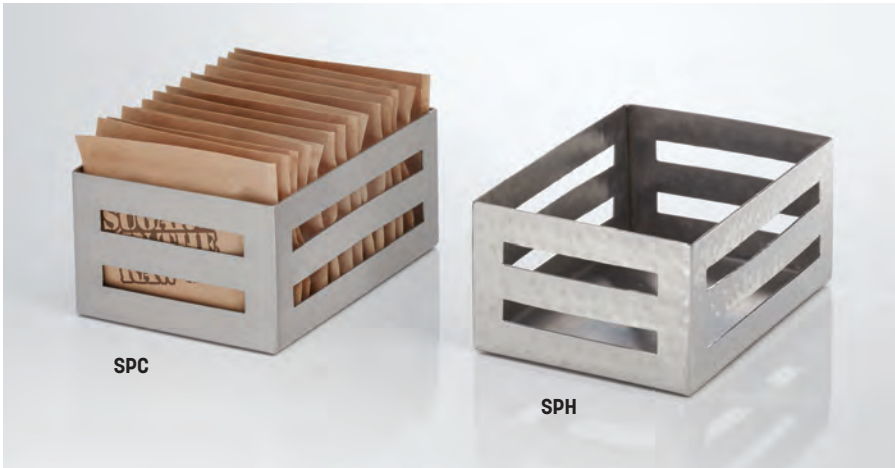

SPC

SPH



DGSP35

GSP35

Ceramic Sugar Packet Holder

SPP326 3 1/2" L x 2 1/2" W x 2" H
(8.9 x 6.4 x 5.1 cm)

Porcelain Sugar Packet Holders

PSPH3 3 1/4" L x 2 1/2" W x 1 7/8" H
(8.3 x 6.4 x 4.8 cm)

PSPH4 4" L x 2 1/4" W x 1 3/4" H
(10.2 x 5.7 x 4.4 cm)

Wrought Iron Sugar Packet Baskets  

SBL353 Leaf
3 3/4" L x 2 3/4" W x 2 1/2" H
(9.5 x 7 x 6.4 cm)

SBS533 Scroll
3 3/4" L x 2 3/4" W x 2 1/2" H
(9.5 x 7 x 6.4 cm)

Birdnest Sugar Packet Baskets  

BNSB3 Black
4 1/2" L x 2 1/4" W x 1 3/4" H
(11.4 x 5.7 x 4.4 cm)

BNSC3 Chrome
4 1/2" L x 2 1/4" W x 1 3/4" H
(11.4 x 5.7 x 4.4 cm)



SPP326



PSPH4

PSPH3



SBS533

SBL353

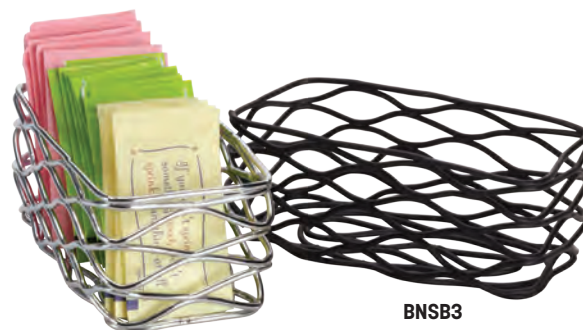

BNSC3

BNSB3



BNCB84

BNCC48



BARS5

HMBAR9



BARC7

BARC5

Birdnest Coffee Caddies

BNCB84 Black
8 1/2" L x 4 3/8" W x 3 1/8" H
(21.6 x 11.1 x 7.9 cm)

BNCC48 Chrome
8 1/2" L x 4 3/8" W x 3 1/8" H
(21.6 x 11.1 x 7.9 cm)

Stainless Steel Coffee Caddies

BARS5 Satin
8" L x 4" W x 4 1/8" H
(20.3 x 10.2 x 10.5 cm)

HMBAR9 Hammered
8" L x 4" W x 4 1/8" H
(20.3 x 10.2 x 10.5 cm)

Antique Copper Caddies

From nooks for your spoons to places to stash your sugar packets, these rustic caddies have everything a barista or barkeep needs.

BARC5 Coffee Caddy
8" L x 4" W x 4 1/8" H
(20.3 x 10.2 x 10.5 cm)

BARC7 Bar Caddy
9 1/8" L x 5 7/8" W x 4 1/8" H
(23.2 x 14.9 x 10.5 cm)

Black Metal Caddies

Our most versatile bar caddies yet, this pair of stylishly functional pieces is perfect for just about any bar setting.

BARB5 8" L x 4" W x 4 1/8" H
(20.3 x 10.2 x 10.5 cm)

BARB7 9 1/8" L x 5 7/8" W x 4 1/8" H
(23.2 x 14.9 x 10.5 cm)



BARB7

BARB5



MELWB

Tabletop Waste Bin

Miniature waste bins are an easy way to improve your customer experience and simplify cleanup.

MELWB 5" Dia. x 6" H
(12.7 x 15.2 cm)

Stainless Steel Swing Waste Bins HOT

TIM3 4" Dia. x 5" H
(10.2 x 12.7 cm)

TIM1 4 ¾" Dia. x 6 ⅝" H
(12.1 x 16.8 cm)

TIM2 4 ¾" Dia. x 9" H
(12.1 x 22.9 cm)

Stainless Steel Mini Trash Cans

OSCAR Can, 3 ¾" Dia. x 3 ½" H
(9.5 x 8.9 cm)

OLID Lid for OSCAR
3 ¾" Dia. x 1 ½" H (9.5 x 3.8 cm)

OSCAR2 Can, 5" Dia. x 4 ⅞" H
(12.7 x 12.4 cm)

OLID2 Lid for OSCAR2
5" Dia. x 1 ⅝" H (12.7 x 4.1 cm)

OSCAR3 Can, 6" Dia. x 5 ⅞" H
(15.2 x 14.9 cm)

OLID3 Lid for OSCAR3
6" Dia. x 1 ⅞" H (15.2 x 4.8 cm)

Sugar and Ice Tongs

IT400 Sugar Tongs
4" L (10.2 cm)

IT700 Hammered Ice Tongs
6 ½" L (16.5 cm)





Shown with GLADT6 glass shaker, PNS24 glass S&P set and MSTNG5 stainless steel tongs

PRODUCTS PWBB45 AND PWBB3 STACK FOR SIMPLE STORAGE

PWBC8

PWBS4

PWBC7

PWBB45

PWBB3



PWC8

PWC7

PWS4

PWB45

PWB3

Poplar Wood Caddies

This five-piece collection provides function and stylish coordination. Choose from rustic natural wood or sleek black.

Black

PWBS4 4" L x 3 5/8" W x 1 5/8" H
(12.1 x 12.7 x 9.5 cm)

PWBB3 3 5/8" L x 3 7/8" W x 3 1/2" H
(19.1 x 16.5 x 13 cm)

PWBB45 4 5/8" L x 5" W x 3 3/4" H
(16.8 x 16.5 x 18.4 cm)

PWBC7 7 1/2" L x 6 1/2" W x 5 1/8" H
(9.2 x 9.8 x 8.9 cm)

PWBC8 6 5/8" L x 6 1/2" W x 7 1/4" H
(10.2 x 9.2 x 4.1 cm)

Natural

PWS4 4" L x 3 5/8" W x 1 5/8" H
(12.1 x 12.7 x 9.5 cm)

PWB3 3 5/8" L x 3 7/8" W x 3 1/2" H
(19.1 x 16.5 x 13 cm)

PWB45 4 5/8" L x 5" W x 3 3/4" H
(16.8 x 16.5 x 18.4 cm)

PWC7 7 1/2" L x 6 1/2" W x 5 1/8" H
(9.2 x 9.8 x 8.9 cm)

PWC8 6 5/8" L x 6 1/2" W x 7 1/4" H
(10.2 x 9.2 x 4.1 cm)



WCV4 shown with BWC12 condiment rack

SEE OUR MATCHING WOOD CRATES ON PG. 271-273

WCV7



WCBA4 shown with TASSM stand, BEE316 shaker and TIM1 waste bin

WCBA7

Wood Caddies

Our crates in vintage, bamboo and black wood are so popular that we have expanded into matching caddies.

Vintage

WCV4 3 7/8" Sq. x 4 3/4" H
(9.8 x 12.1 cm)

WCV7 7 1/2" L x 6 1/4" W x 4 3/4" H
(19.1 x 15.9 x 12.1 cm)

Bamboo

WCBA4 3 7/8" Sq. x 4 3/4" H
(9.8 x 12.1 cm)

WCBA7 7 1/2" L x 6 1/4" W x 4 3/4" H
(19.1 x 15.9 x 12.1 cm)

Black

WCBL4 3 7/8" Sq. x 4 3/4" H
(9.8 x 12.1 cm)

WCBL7 7 1/2" L x 6 1/4" W x 4 3/4" H
(19.1 x 15.9 x 12.1 cm)



PERFECT FOR COFFEE STATIONS



WCBL7

WCBL4



Porcelain Sauce/Fry Cups

You might start calling your french fries "pomme frites" after elevating them with these elegant porcelain cups.

White

- PCWH2** 2 oz. (59.1 mL)
2" Dia. x 1 1/2" H (5.1 x 3.8 cm)
- PCWH4** 4 oz. (118.3 mL)
2 3/4" Dia. x 2" H (7 x 5.1 cm)
- PCWH10** 10 oz. (295.7 mL)
3 1/8" Dia. x 3" H (7.9 x 7.6 cm)

Gray

- PCG2** 2 oz. (59.1 mL)
2" Dia. x 1 1/2" H (5.1 x 3.8 cm)
- PCG4** 4 oz. (118.3 mL)
2 3/4" Dia. x 2" H (7 x 5.1 cm)
- PCG10** 10 oz. (295.7 mL)
3 1/8" Dia. x 3" H (7.9 x 7.6 cm)



Porcelain Three-Compartment Sauce Dish

Try serving sauces, tiny desserts, hors d'oeuvres and more in this elegant, low-profile triptych.

- PORS3R** 1 1/2 oz. (44.4 mL)
5 3/4" L x 3 1/8" W x 1" H
(14.6 x 7.9 x 2.5 cm)

Mini Ceramic Fry Pan

The pouring spout and handle on this petite piece make it exceptionally versatile.

- CFP4** 4 oz. (118.3 mL)
3 1/2" Dia. x 1 1/2" H
5 1/8" W with Handle
(13 x 8.9 x 3.8, 13 cm)





Round and Square Porcelain Sauce Cups

Originally designed for sauces, these beauties also set the stage for salts, oils, condiments and more.

- PRSD3** 1 ½ oz. (44.4 mL)
3" Dia. x ¾" H (7.6 x 1.9 cm)
- PSLT17** ½ oz. (14.8 mL)
1 ¾" Dia. x ¾" H (4.4 x 1.9 cm)
- PSLT2** 1 oz. (29.6 mL)
2 ⅞" Dia. x 1" H (5.4 x 2.5 cm)

Squavy™ Porcelain Sauce Cups

- SQVY1** 1 ½ oz. (44.4 mL)
2 ¼" Dia. x 1 ½" H (5.7 x 3.8 cm)
- SQVY2** 2 ½ oz. (73.9 mL)
2 ½" Dia. x 1 ⅝" H (6.4 x 4.1 cm)
- SQVY3** 5 oz. (147.9 mL)
3 ½" Dia. x 1 ⅞" H (8.9 x 4.8 cm)
- SQVY4** 15 oz. (443.6 mL)
4 ½" Dia. x 2 ½" H (11.4 x 6.6 cm)

Squound™ Ceramic Sauce Cups

- SQSC15** 1 ½ oz. (44.4 mL)
2 ¾" Dia. x 1" H (7 x 2.5 cm)
- SQSC20** 2 oz. (59.1 mL)
2 ¾" Dia. x 1" H (7 x 2.5 cm)
- SQSC30** 3 oz. (88.7 mL)
3 ½" Dia. x 1 ¼" H (8.9 x 3.2 cm)
- SQSC40** 4 oz. (118.3 mL)
4" Dia. x 1 ½" H (10.2 x 3.8 cm)





Ceramekins™

- CRMK1** 1 oz. (29.6 mL)
2 ¼" Dia. x 1 ¼" H (5.7 x 3.2 cm)
- CRMK2** 2 oz. (59.1 mL)
2 ¾" Dia. x 1 ¼" H (7 x 3.2 cm)
- CRMK275** 2 ¾ oz. (81.3 mL)
2 ¾" Dia. x 1 ¼" H (7 x 3.2 cm)
- CRMK3** 4 oz. (118.3 mL)
3 ⅜" Dia. x 1 ⅝" H (8.6 x 4.1 cm)
- CRMK4** 4 oz. (118.3 mL)
3 ½" Dia. x 1 ⅝" H (8.9 x 4.1 cm)
- CRMK45** 5 oz. (147.9 mL)
3 ⅝" Dia. x 1 ⅝" H (9.2 x 4.1 cm)
- CRMK6** 6 oz. (177.4 mL)
3 ⅝" Dia. x 1 ⅝" H (9.5 x 4.1 cm)

Square Porcelain Sauce Cups

When a culinary experience consists of a single bite, these porcelain cups are the perfect solution.

- CSC15** 1 ½ oz. (44.4 mL)
1" Sq. x 1 ⅞" H (2.5 x 2.9 cm)
- CSC20** 2 oz. (59.1 mL)
2 ½" Sq. x 1 ⅜" H (6.4 x 3.5 cm)
- PORD39** 2 oz. (59.1 mL)
3" Sq. x 1" H (7.6 x 2.5 cm)
- PORB29** 4 oz. (118.3 mL)
3" Sq. x 2" H (7.6 x 5.1 cm)
- PORB30** 6 ½ oz. (192.2 mL)
3 ¼" Sq. x 2 ¼" H (8.3 x 5.7 cm)



BEAUTIFUL SATIN FINISH
MEETS FUN FLARED DESIGN

Flared Stainless Steel Sauce Cups

- FT15** 2 oz. (59.1 mL)
2 5/8" Dia. x 1 1/4" H (6.7 x 3.2 cm)
- FT25** 3 oz. (88.7 mL)
3" Dia. x 1 1/2" H (7.6 x 3.8 cm)
- FT40** 4 oz. (118.3 mL)
3 3/8" Dia. x 1 7/8" H (8.6 x 4.8 cm)

Double-Wall Stainless Steel Sauce Cups

- DWSC3** 3 oz. (88.7 mL)
2 1/2" Dia. x 2 3/8" H (6.5 x 6 cm)
- DWSC7** 7 oz. (207 mL)
3 3/8" Dia. x 2 5/8" H (8.6 x 6.7 cm)
- DWSC85** 8 1/2 oz. (251.4 mL)
3 5/8" Dia. x 3" H (9.3 x 7.5 cm)



SATIN FINISH DELIVERS
EASY ELEGANCE

HOT

STAINLESS STEEL MAKES THIS COLLECTION SHINE



Stainless Steel Sauce Cups HOT

- MB3** 1 ½ oz. (44.4 mL)
2 ½" Dia. x 1" H (6.4 x 2.5 cm)
- MB1** 2 ½ oz. (73.9 mL)
2 ¼" Dia. x 1 ¾" H (5.7 x 4.4 cm)
- MB4** 4 oz. (118.3 mL)
3" Dia. x 2" H (7.6 x 5.1 cm)
- SSC15** 1 ½ oz. (44.4 mL)
2 ¾" Sq. x 1" H (6 x 2.5 cm)
- D404** 1 ½ oz. (44.4 mL)
2 ¾" L x 2" W x 1 ½" H (7 x 5.1 x 1.3 cm)
- D405** 2 ½ oz. (73.9 mL)
3 ⅞" L x 3" W x 7 ⅞" H
(9.8 x 7.6 x 2.2 cm)
- SSC25** 2 ½ oz. (73.9 mL)
2 ¾" Sq. x 1 ⅜" H (6 x 3.5 cm)
- D406** 4 oz. (118.3 mL)
4 ⅝" L x 3 ¾" W x 7 ⅞" H
(11.7 x 9.5 x 2.2 cm)
- B34** 3 ½ oz. (103.5 mL)
3 ¼" Dia. x 1 ¼" H (8.3 x 3.2 cm)

Large Capacity Stainless Steel Sauce Cups

- B31** Mirror Finish
8 oz. (236.6 mL)
3 ⅝" Dia. x 2 ¼" H (9.2 x 5.7 cm)
- BS31** Satin Finish
8 oz. (236.6 mL)
3 ⅝" Dia. x 2 ¼" H (9.2 x 5.7 cm)
- BH31** Hammered
8 oz. (236.6 mL)
3 ⅝" Dia. x 2 ¼" H (9.2 x 5.7 cm)



Fluted Stainless Steel Sauce Cups

RB15 1 ½ oz. (44.4 mL)
2 ½" Dia. x 7⁄8" H (6.4 x 2.2 cm)

RB25 2 ½ oz. (73.9 mL)
2 ¾" Dia. x 1 ⅝" H (6 x 4.1 cm)

Ribbed Stainless Steel Sauce Cups

RSC3 1 ½ oz. (44.4 mL)
2 ½" Dia. x 1" H (6.4 x 2.5 cm)

RSC1 2 ½ oz. (73.9 mL)
2 ¼" Dia. x 1 ¾" H (5.7 x 4.4 cm)

RSC4 4 oz. (118.3 mL)
3" Dia. x 2" H (7.6 x 5.1 cm)



Round Hammered Stainless Steel Sauce Cups HOT

HAMSC3 1 ½ oz. (44.4 mL)
2 ¼" Dia. x 1" H (5.7 x 2.5 cm)

HAMSC 2 ½ oz. (73.9 mL)
2 ¼" Dia. x 1 ¾" H (5.7 x 4.4 cm)

HAMSC4 4 oz. (118.3 mL)
2 ½" Dia. x 2" H (6.4 x 5.1 cm)

Square Hammered Stainless Steel Sauce Cups

HAMSC15 1 ½ oz. (44.4 mL)
2" Sq. x 1" H (5.1 x 2.5 cm)

HAMSC25 2 ½ oz. (73.9 mL)
2 ¼" Sq. x 1 ¼" H (5.7 x 3.2 cm)





Straight-Sided Stainless Steel Mini Bowls

- SMB3** Satin Finish, 4 oz. (118.3 mL)
3" Dia. x 1" H (7.6 x 2.5 cm)
- SMB4** Satin Finish, 8 oz. (236.6 mL)
4" Dia. x 1 1/4" H (10.2 x 3.2 cm)
- SMB5** Satin Finish, 15 oz. (443.6 mL)
5" Dia. x 1 1/4" H (12.7 x 3.2 cm)

Double-Wall Stainless Steel Angled Mini Bowls

Satin Finish

- DWS2** 2.5 oz. (73.9 mL)
3" Dia. x 2 3/4" H (7.6 x 7 cm)
- DWSS5** 5 oz. (147.9 mL)
3 1/2" Dia. x 3" H (8.9 x 7.6 cm)

Hammered

- HDWS2** 2.5 oz. (73.9 mL)
3" Dia. x 2 3/4" H (7.6 x 7 cm)
- HDWS5** 5 oz. (147.9 mL)
3 1/2" Dia. x 3" H (8.9 x 7.6 cm)





Oval Hammered Sauce Cups

These tiny oval sauce cups dress up any dish in need of an accompaniment. Available in two sleek finishes and multiple sizes.

Stainless Steel

- HS2** 2 oz. (59.1 mL)
2 ½" L x 2" W x 1 ¼" H
(6.3 x 5 x 3.1 cm)
- HS3** 3 oz. (88.7 mL)
2 ¾" L x 2" W x 1 ¼" H
(6.9 x 5 x 3.1 cm)
- HS4** 4 oz. (118.3 mL)
3 ¼" L x 2 ¾" W x 1 ½" H
(8.2 x 6.9 x 3.8 cm)
- HS8** 8 oz. (236.5 mL)
3 ¾" L x 3" W x 2" H
(9.5 x 7.6 x 5 cm)

Copper

- HSC2** 2 oz. (59.1 mL)
2 ½" L x 2" W x 1 ¼" H
(6.3 x 5 x 3.1 cm)
- HSC3** 3 oz. (88.7 mL)
2 ¾" L x 2" W x 1 ¼" H
(6.9 x 5 x 3.1 cm)
- HSC4** 4 oz. (118.3 mL)
3 ¼" L x 2 ¾" W x 1 ½" H
(8.2 x 6.9 x 3.8 cm)
- HSC8** 8 oz. (236.5 mL)
3 ¾" L x 3" W x 2" H
(9.5 x 7.6 x 5 cm)





NEW

MMP8

MMP6

Mini Melamine Serving Dishes NEW

Let's face it. Cute sells and these mini melamine bowls and plates are the epitome of adorable! Use as a small dish to plate up small bites or to creatively serve sauces and condiments. The mini platters can be used for anything from a dessert dish to a check presenter! These guys may be small, but they pack a powerful punch in versatility.

Rectangular Plates

- MMP6** 6 5/8" L x 4 3/8" W x 7/8" H
(16.8 x 11.1 x 2.2 cm)
- MMP8** 8 1/2" L x 5 3/4" W x 1" H
(21.6 x 14.6 x 2.5 cm)

Round Bowls

- MMB3** 3 oz. (88.7 mL)
3 3/4" Dia. x 1 1/8" H
(9.5 x 2.9 cm)
- MMB6** 6 oz. (177.4 mL)
4 1/2" Dia. x 1 1/4" H
(11.4 x 3.2 cm)
- MMB9** 9 oz. (266.2 mL)
5 1/2" Dia. x 1 3/8" H
(14 x 3.5 cm)

Handled Bowls

- MMBH3** 3 oz. (88.7 mL)
4" L x 3 5/8" W x 2 1/4" H
(10.2 x 2.9 x 5.7 cm)
- MMBH7** 7 oz. (207 mL)
4 1/4" L x 4 3/4" W x 3" H
(10.8 x 12.1 x 7.6 cm)

Shaped Bowls

- MMOB1** 1 1/2 oz. (44.4 mL)
4 5/8" L x 2 5/8" W x 2 1/8" H
(11.7 x 6.7 x 5.4 cm)
- MMOB2** 2 oz. (59.1 mL)
4 1/4" L x 3 3/8" W x 1" H
(10.8 x 8.6 x 2.5 cm)
- MMOB25** 2 1/2 oz. (73.9 mL)
4 1/4" L x 2 1/2" W x 1 5/8" H
(10.8 x 6.4 x 4.1 cm)
- MMOB3** 3 oz. (88.7 mL)
5 1/2" L x 3" W x 1 1/4" H
(14 x 7.6 x 3.2 cm)



MMB6

NEW

MMB9

MMB3



NEW

MMBH7

MMBH3



MMOB1

NEW

MMOB3

MMOB25

MMOB2

Unity Collection Sauce Cups NEW

Round

USCR2GE Graphite
2 oz. (59.1 mL)
2 1/2" Dia. x 1 5/8" H
(6.4 x 4.1 cm)

USCR2MO Mocha
2 oz. (59.1 mL)
2 1/2" Dia. x 1 5/8" H
(6.4 x 4.1 cm)

Square

USCS2GE Graphite
2 oz. (59.1 mL)
2" Sq. x 1 5/8" H
(5.1 x 4.1 cm)

USCS2MO Mocha
2 oz. (59.1 mL)
2" Sq. x 1 5/8" H
(5.1 x 4.1 cm)



Crave Collection Sauce Cups NEW

CSC4SH Shadow
4 1/2 oz. (133.1 mL)
3 1/4" Dia. x 2" H
(8.3 x 5.1 cm)

CSC4CL Cloud
4 1/2 oz. (133.1 mL)
3 1/4" Dia. x 2" H
(8.3 x 5.1 cm)

CSC4ST Storm
4 1/2 oz. (133.1 mL)
3 1/4" Dia. x 2" H
(8.3 x 5.1 cm)
(not shown)



Jane Collection Sauce Cups

DSC1WH 1 oz. (29.6 mL)
2 3/4" Dia. x 7/8" H
(7 x 2.2 cm)

DSC3WH 2 3/4 oz. (81.3 mL)
3 1/2" Dia. x 1" H
(8.9 x 2.5 cm)

MSC8 8 oz. (236.6 mL)
3 5/8" Dia. x 2 1/8" H
(9.2 x 5.4 cm)



Shown with THW8 taco holder



MSCSB3

MSCRW2

STYLISHLY STACKABLE
FOR PRESENTATION AND
STORAGE

MSCRB2

MSCSW3



MELBPH

Matte Finish Melamine Stackable Sauce Cups

Round

MSCRB2 Black, 2 ½ oz. (73.9 mL)
2 ¾" Dia. x 1 ¾" H (6 x 4.5 cm)

MSCRW2 White, 2 ½ oz. (73.9 mL)
2 ¾" Dia. x 1 ¾" H (6 x 4.5 cm)

Square

MSCSB3 Black, 3 oz. (88.7 mL)
2 ¾" Sq. x 1 ¾" H (6 x 4.5 cm)

MSCSW3 White, 3 oz. (88.7 mL)
2 ¾" Sq. x 1 ¾" H (6 x 4.5 cm)

Melamine Butter Dish

MELBPH 1 oz. (29.6 mL)
2 ½" Dia. x 1 ⅞" H (6.4 x 2.9 cm)



CRAFTED TO BE DURABLE
AND DISHWASHER-SAFE

TSCB2

TSCB4

TSCB15

Black Triangular Bamboo Fiber Sauce Cups

TSCB15 1 ½ oz. (44.4 mL)
2 ½" Triangle x 1 ⅜" H (6.4 x 3.5 cm)

TSCB2 2 oz. (59.1 mL)
2 ⅝" Triangle x 1 ½" H (6.7 x 3.8 cm)

TSCB4 4 oz. (118.3 mL)
3 ¼" Triangle x 1 ½" H (8.3 x 3.8 cm)

Melamine Ramekins**White with Smooth Sides**

MRS150W	1 ½ oz. (44.4 mL) 2 ¾" Dia. x 1 ½" H (6 x 3.8 cm)
MRS200W	2 oz. (59.1 mL) 2 7/8" Dia. x 1 ½" H (7.3 x 3.8 cm)
MRS300W	3 oz. (88.7 mL) 3 ¼" Dia. x 1 7/8" H (8.3 x 4.8 cm)
MRS400W	4 oz. (118.3 mL) 3 ¼" Dia. x 2" H (8.3 x 5.1 cm)
MRS600W	6 oz. (177.4 mL) 3 7/8" Dia. x 2" H (9.8 x 5.1 cm)

Black with Smooth Sides

MRS150BL	1 ½ oz. (44.4 mL) 2 ¾" Dia. x 1 ½" H (6 x 3.8 cm)
MRS200BL	2 oz. (59.1 mL) 2 7/8" Dia. x 1 ½" H (7.3 x 3.8 cm)
MRS300BL	3 oz. (88.7 mL) 3 ¼" Dia. x 1 7/8" H (8.3 x 4.8 cm)
MRS400BL	4 oz. (118.3 mL) 3 ¼" Dia. x 2" H (8.3 x 5.1 cm)
MRS600BL	6 oz. (177.4 mL) 3 7/8" Dia. x 2" H (9.8 x 5.1 cm)

White with Fluted Sides

MRF150W	1 ½ oz. (44.4 mL) 2 ½" Dia. x 1 ½" H (6.4 x 3.8 cm)
MRF250W	2 oz. (59.1 mL) 2 ¾" Dia. x 1 ½" H (7 x 3.8 cm)
MRF350W	3 oz. (88.7 mL) 3 ½" Dia. x 1 5/8" H (7.9 x 4.1 cm)
MRF450W	4 oz. (118.3 mL) 3 ¼" Dia. x 2" H (8.3 x 5.1 cm)

Black with Fluted Sides

MRF150BL	1 ½ oz. (44.4 mL) 2 ½" Dia. x 1 ½" H (6.4 x 3.8 cm)
MRF250BL	2 oz. (59.1 mL) 2 ¾" Dia. x 1 ½" H (7 x 3.8 cm)
MRF350BL	3 oz. (88.7 mL) 3 ½" Dia. x 1 5/8" H (7.9 x 4.1 cm)
MRF450BL	4 oz. (118.3 mL) 3 ¼" Dia. x 2" H (8.3 x 5.1 cm)

Square Melamine Sauce Cups**White**

MELSC15	1 oz. (29.6 mL) 2" Sq. x 1 3/8" H (5.1 x 3.5 cm)
MELSC20	2 oz. (59.1 mL) 2 ½" Sq. x 1 5/8" H (6.4 x 4.1 cm)

Black

MELSCB51	1 oz. (29.6 mL) 2" Sq. x 1 3/8" H (5.1 x 3.5 cm)
MELSCB21	2 oz. (59.1 mL) 2 ½" Sq. x 1 5/8" H (6.4 x 4.1 cm)





Porcelain Gravy Boats

This classic design comes in three different sizes.

- GB3** 3 oz. (88.7 mL)
6" L x 1 3/4" W x 3 1/2" H
(15.2 x 4.5 x 8.9 cm)
- GB8** 9 oz. (266.2 mL)
8" L x 2 3/4" W x 5" H
(20.3 x 7 x 12.7 cm)
- GB16** 16 oz. (473.2 mL)
9" L x 3 1/2" W x 5 1/4" H
(22.9 x 8.9 x 13.3 cm)

Porcelain Sauce Server

Creamer by day and gravy boat by night, this modern piece features organic curves and a unique handle-free design.

- CM4** 4 oz. (118.3 mL)
3 3/4" L x 2 3/4" W x 2" H
(9.5 x 7 x 5.1 cm)



GB1600



GB1000



GB500



GB300

Stainless Steel Gravy Boats

Perfect for gravy or salad dressings.

GB300 3 oz. (88.7 mL)
5 7/8" L x 2 5/8" W x 2 7/8" H (14.9 x 6.7 x 7.3 cm)

GB500 5 oz. (147.9 mL)
7 1/8" L x 3" W x 2 3/4" H (18.1 x 7.6 x 7.9 cm)

GB1000 10 oz. (295.7 mL)
8 3/4" L x 3 3/4" W x 3 1/4" H (22.2 x 9.5 x 8.3 cm)

GB1600 16 oz. (473.2 mL)
9 1/4" L x 4 3/4" W x 4 3/4" H (23.5 x 12.1 x 12.1 cm)

Stainless Steel Bell Creamers/Syrup Servers

Stainless steel with mirror finish.

CP300 3 oz. (88.7 mL)
2 1/8" L x 3 3/4" W x 2 3/8" H (5.4 x 9.5 x 6 cm)

CP500 5 oz. (147.9 mL)
2 1/2" L x 4 1/4" W x 2 7/8" H (6.4 x 10.8 x 7.3 cm)

CP300



CP500



Ceramic Bud Vases

These simple black and white vases are designed to make the flowers inside pop with color.

BVJGB5 Black Jug
2 1/8" W x 3 7/8" H (5.4 x 9.8 cm)

BVTB7 Black Tower
1 1/2" W x 4" H (3.8 x 10.2 cm)

BVJGG4 White Jug
2" W x 3 7/8" H (5.1 x 9.8 cm)

BVTG6 White Tower
1 1/2" W x 4" H (3.8 x 10.2 cm)





2 oz. Contemporary Glass Shakers

With glass bodies and a variety of stainless steel tops, these shakers feature eye-catching contemporary design. 2" Dia. x 3 1/8" H (5.1 x 7.9 cm).

GLACT2 Shaker with Cheese Top

GLAST2 Shaker with Slotted Top

GLADT2 Shaker with Adjustable Dial Top

GLBASE Shaker Base Only

Replacement Shaker Tops

CT2 Cheese Round

ST2 Spice Slotted

DT2 Adjustable Dial Top

CAP2 Plastic Cover for Top

6 oz. Contemporary Glass Shakers

This stylishly modern line of glass shakers is an instant classic. Each measures in at 2 3/8" Dia. x 4 1/2" H (6 x 11.4 cm).

4406 Shaker with Cheese Top

4407 Shaker with Slotted Top

GLADT6 Shaker with Adjustable Dial Top

GLA600 Shaker Base Only

Replacement Shaker Tops

4406T Cheese Round
2 3/4" Dia. x 1 1/8" H (7 x 2.9 cm)

4407T Spice Slotted
2 3/4" Dia. x 1 1/8" H (7 x 2.9 cm)

DT6 Adjustable Dial Top
2 3/4" Dia. x 1 1/8" H (7 x 2.9 cm)

CAP25 Plastic Cover for Top



6 oz. Vintage Glass Shakers

Part of the Vintage Collection that includes the salt & pepper shakers on pg. 135, these cheese and spice shakers feature stainless steel caps and are dishwasher-safe.

GSC6 Shaker with Cheese Top
6 oz. (177.4 mL)
2 5/8" Sq. x 3 3/4" H (6.7 x 9.5 cm)

GSS6 Shaker with Slotted Top
6 oz. (177.4 mL)
2 5/8" Sq. x 3 3/4" H (6.7 x 9.5 cm)

GSD6 Shaker with Adjustable Dial Top
6 oz. (177.4 mL)
2 5/8" Sq. x 3 3/4" H (6.7 x 9.5 cm)



4 oz. Mason Jar Salt & Pepper Shaker Set

For a fun alternative use of these shakers, remove the caps and pair them with our flight boards (pg. 325) for craft beer tastings.

MSP4 4 oz. (118.3 mL)
5" L x 4 3/4" W x 4" H
(12.7 x 12.1 x 10.2 cm)

MMJS [4] Shaker Bases Only, 4 oz. (118.3 mL)
5" L x 4 3/4" W x 4" H
(12.7 x 12.1 x 10.2 cm)

6 oz. Swirl Jar Shakers

Our take on classic pizzeria styling. 6 oz. (177.4 mL) capacity. 2 5/8" Dia. x 3 1/2" H (6.7 x 8.9 cm).

Glass

3306 Shaker with Cheese Top

3307 Shaker with Spice Top

PET

LX306 Shaker with Cheese Top
(not shown)

LX307 Shaker with Spice Top
(not shown)

Shipped complete with tops.

8 oz. Glass Shakers

Ideal for condiments such as red pepper, oregano and parmesan cheese. 8 oz. (236.6 mL) capacity. 2 3/4" Dia. x 3 7/8" H (7 x 9.8 cm).

3308 Shaker with Cheese Top

3309 Shaker with Spice Top

16 oz. Satin Finish Stainless Steel Shakers

In stainless steel, these shakers feature fine or coarse holes for different seasonings. 16 oz (473.2 mL) capacity. 3" Dia. x 7" H (7.6 x 17.8 cm).

TSF7 Shaker with Fine Holes

TSC7 Shaker with Coarse Holes





BEE312

BEE317

BEE319

BEE318

BEE316



BHM2

BEE607

BEE606



12 oz. Glass Beehive Shakers

Our line of stylishly ridged beehive shakers begins with these standard 12 oz. (354.9 mL) pieces. 3" Dia. x 5 3/8" H (7.6 x 13.7 cm).

- BEE312** Shaker with Cheese Top
- BEE316** Shaker with Sugar Top
- BEE317** Shaker with Spice Top
- BEE318** Shaker with Dredge Top
- BEE319** Shaker with Extra Large Holes Cheese Top
- BEE300** Shaker Base Only

2 oz. and 6 oz. Glass Beehive Shakers

These 6 oz. (177.4 mL) and 2 oz. (59.1 mL) beehive shakers feature a charming pear-shaped design.

- BHM2** Salt & Pepper Shakers
2 oz. (59.1 mL)
2" Dia. x 4" H (5.1 x 10.2 cm)
- BEE606** Shaker with Cheese Top
- BEE607** Shaker with Spice Top
- BEE600** Shaker Base Only
6 oz. (177.4 mL)



12 oz. Shakers

These 12 oz. (354.9 mL) fluted shakers are stain-proof, dishwasher-safe and crafted from nearly indestructible SAN plastic or crystal clear glass. Sugar top has a self-closing flap. 3" Dia. x 5 3/8" H (7.6 x 13.7 cm).

Glass

- GLA312** Shaker with Cheese Top
- GLA316** Shaker with Sugar Top
- GLA317** Shaker with Spice Top
- GLA318** Shaker with Dredge Top
- GLA319** Shaker with Extra Large 1/4" Holes Cheese Top
- GLA300** Shaker Base Only

SAN Plastic

- SAN312** Shaker with Cheese Top
- SAN316** Shaker with Sugar Top
- SAN317** Shaker with Spice Top
- SAN318** Shaker with Dredge Top
- SAN319** Shaker with Extra Large 1/4" Holes Cheese Top
- SAN300** Shaker Base Only

12 oz. Plastic Shakers

These 12 oz. (354.9 mL) paneled shakers are stain-proof, dishwasher-safe and crafted from nearly indestructible plastic. Sugar top has a self-closing flap.

3" Dia. x 5 3/8" H (7.6 x 13.7 cm).

- 3312** Shaker with Cheese Top
- 3316** Shaker with Sugar Top
- 3317** Shaker with Spice Top
- 3318** Shaker with Dredge Top
- 3319** Shaker with Extra Large 1/4" Holes Cheese Top
- 3300** Shaker Base Only



BSD64



Beehive Syrup Dispenser

The breakfast-ready accompaniment to our beehive shakers.

- BSD64** Syrup Dispenser with Side Spring Flap Lid
6 oz. (177.4 mL)
4" Dia. x 4 1/8" H (10.2 x 10.5 cm)

SGL106 Chrome Syrup Lid

Mini Glass Shakers and Caddy

This stainless steel rack and its matching glass shakers are a fraction of the size of regular shakers.

MGLA3 2 oz. (59.1 mL) Jar
1 5/8" Dia. x 3 5/8" H (4.1 x 9.2 cm)

MCADDY Caddy
4 1/2" L x 2 1/4" W x 5 1/2" H (11.4 x 5.7 x 14 cm)

MGLCS Set (Includes Caddy and Cheese and Spice Shakers)

Replacement Shaker Tops

M30SP Salt and Pepper

M312T Cheese

M316T Sugar Top Flap

M317T Spice

Shaker Tops

6 oz. and 8 oz. Tops

3307T Spice Slotted

3306T Cheese Round

12 oz. Tops

3312T Cheese

3316T Sugar Top Flap

3317T Slotted Spice

3319T Cheese Shaker with Extra Large Holes (1/4" Hole)

3318T Dredge with Small Round Holes



MGLCS



Glass Lightbulb Salt & Pepper Shaker Sets

A shaker and conversation piece, all in one. These eclectic shakers look just like the real thing, come in three sizes and feature stainless steel caps.

- SPLB6** 1 ½ oz. (44.4 mL)
1 ¾" Dia. x 3" H (4.4 x 7.6 cm)
- SPLB7** 4 oz. (118.3 mL)
2 ½" Dia. x 4" H (5.4 x 10.2 cm)
- SPLB9** 8 oz. (236.6 mL)
2 ½" Dia. x 5" H (6.4 x 12.7 cm)
- SPLBCAP** Replacement Caps
1" Dia. x ¾" H (2.5 x 1.9 cm)



Vintage Glass Salt & Pepper Sets

A timeless way to keep the essentials on hand, these salt & pepper sets add a dash of retro style to diner booths and dinner tables.

- GSPR** Ribbed Round
2 oz. (59.1 mL)
1 ½" Dia. x 4 ½" H (3.8 x 11.4 cm)
- GSPC** Round
2 oz. (59.1 mL)
1 ½" Dia. x 4 ½" H (3.8 x 11.4 cm)
- GSPSR** Ribbed Square
2 oz. (59.1 mL)
2" Sq. x 2 ½" H (5.1 x 6.3 cm)
- GSPS** Square
2 oz. (59.1 mL)
2" Sq. x 2 ½" H (5.1 x 6.3 cm)
- GR2** Replacement Caps
1 ½" Dia. x ½" H (3.8 x 1.3 cm)



Vintage Salt & Pepper Caddies

Specifically designed to go with our Vintage Salt & Pepper Shakers, this beautiful caddy is crafted from your choice of acacia or stainless steel for a timeless look. Shakers sold separately.

Acacia Wood

- CADDYW** Fits GSPR and GSPC S&P Shakers
5" L x 2 ½" W x 6 ¾" H
(12.7 x 6.4 x 17.1 cm)

Stainless Steel

- CADDYSS** Fits GSPR and GSPC S&P Shakers
4 ¾" L x 2 ½" W x 6 ½" H
(12.1 x 6.4 x 16.5 cm)





Glass Salt & Pepper Shakers

These classically shaped shakers feature paneled glass and chrome or stainless steel tops. Your choice of top style: Petite, Eiffel Tower, Mushroom Cap or Bullet.

- SP125** Petite
½ oz. (14.8 mL)
2" H (5 cm)
- SP126** Eiffel Tower
1 ¼ oz. (37 mL)
4 ½" H (11.4 cm)
- PNS13** Mushroom Cap
1 oz. (29.6 mL)
3" H (7.6 cm)
- PNS24** Mushroom Cap
2 oz. (59.1 mL)
4" H (10.2 cm)
- BPNS115** Bullet
1 ½ oz. (44.4 mL)
3" H (7.6 cm)
- TOPPNS1** Replacement Tops for PNS24



Acrylic Salt & Pepper Combo

Save table space with this rectangular two-in-one shaker.

- CPM62** 3 ½ oz. (103.5 mL)
1 ½" Sq. x 6 ½" H
(3.8 x 16.5 cm)



Ceramic Triangular Salt & Pepper Shaker Set

Simple, elegant and unadorned, these shakers fit in any setting.

CTSP3 Triangle
2 oz. (59.1 mL)
3 ¼" H (9.5 cm)

Ceramic Mason Jar Salt & Pepper Shaker Set

Bring farm-to-table charm to your presentation with these Mason jar-inspired shakers.

CMSP 2 oz. (59.1 mL)
1 ½" Dia. x 3" H
(3.8 x 7.6 cm)



Ceramic Classic Salt & Pepper Shaker Set

A modern take on classic shaker styling, this set impresses with pure white design.

CSP 2 oz. (59.1 mL)
1 ½" Sq. x 4" H
(3.8 x 10.2 cm)



Ceramic Bottle Salt & Pepper Shaker Set

Mimicking lidded bottles, these one-piece shakers are subtly clever in their design.

CSPW 2 oz. (59.1 mL)
1 ⅞" Dia. x 2 ⅜" H
(7.3 x 6 cm)





Ceramic Salt & Pepper Shaker Sets

In your choice of three contemporary shapes, these simple shakers deliver graphic simplicity.

- CSPT2** Round Tapered, 2 ½ oz. (73.9 mL)
1 ¾" Dia. x 3" H (4.4 x 7.6 cm)
- CSPS3** Square, 2 ½ oz. (73.9 mL)
3 ¼" Sq. x 3 ⅝" H (8.3 x 8.6 cm)
- CSPR1** Round, 2 ½ oz. (73.9 mL)
3 ¼" Dia. x 3 ⅝" H (8.3 x 8.6 cm)
- CCPLUGS** Replacement Stoppers

Porcelain Salt & Pepper Set

The artful simplicity of these teardrop-shaped shakers complements even the most refined table settings.

- PSP2** 2 oz. (59.1 mL)
2" Dia. x 2 ¼" H (5.1 x 5.7 cm)

Porcelain Salt & Pepper Dishes

Incorporate a tactile element into your dinner service by replacing "shake" with "pinch."

- PSLT17** ½ oz. (14.8 mL)
1 ¾" Dia. x ¾" H (4.4 x 1.9 cm)
- PSLT2** 1 oz. (29.6 mL)
2 ⅝" Dia. x 1" H (5.4 x 2.5 cm)



Stainless Steel Salt & Pepper Shaker Sets

This contemporary design can read as futuristic, industrial or just plain stylish depending on the setting.

SSP2 Brushed Finish, 2 oz. (59.1 mL)
1 3/4" Dia. x 2 3/4" H (4.4 x 7 cm)

HMSP2 Hammered Finish, 2 oz. (59.1 mL)
1 3/4" Dia. x 2 3/4" H (4.4 x 7 cm)

HMPLUGS Clear Replacement Stoppers

Copper Salt & Pepper Shaker Sets

The copper trend is here to stay. Keep up by choosing from these two styles of salt & pepper shaker sets.

CSP2 Brushed Finish, 2 oz. (59.1 mL)
1 3/4" Dia. x 2 3/4" H (4.4 x 7 cm)

CHSP2 Hammered Finish, 2 oz. (59.1 mL)
1 3/4" Dia. x 2 3/4" H (4.4 x 7 cm)

HMPLUGS Clear Replacement Stoppers

Hammered Salt & Pepper Shaker Sets

Crafted from hammered metal, these salt & pepper shakers feature a beautiful, rich texture along with a touch of color.

BHSP2 Black, 2 oz. (59.1 mL)
1 3/4" Dia. x 2 3/4" H (4.4 x 7 cm)

BHMPLUGS Black Replacement Stoppers

GHSP2 Gold, 2 oz. (59.1 mL)
1 3/4" Dia. x 2 3/4" H (4.4 x 7 cm)

WHSP2 White, 2 oz. (59.1 mL)
1 3/4" Dia. x 2 3/4" H (4.4 x 7 cm)

HMPLUGS Clear Replacement Stoppers



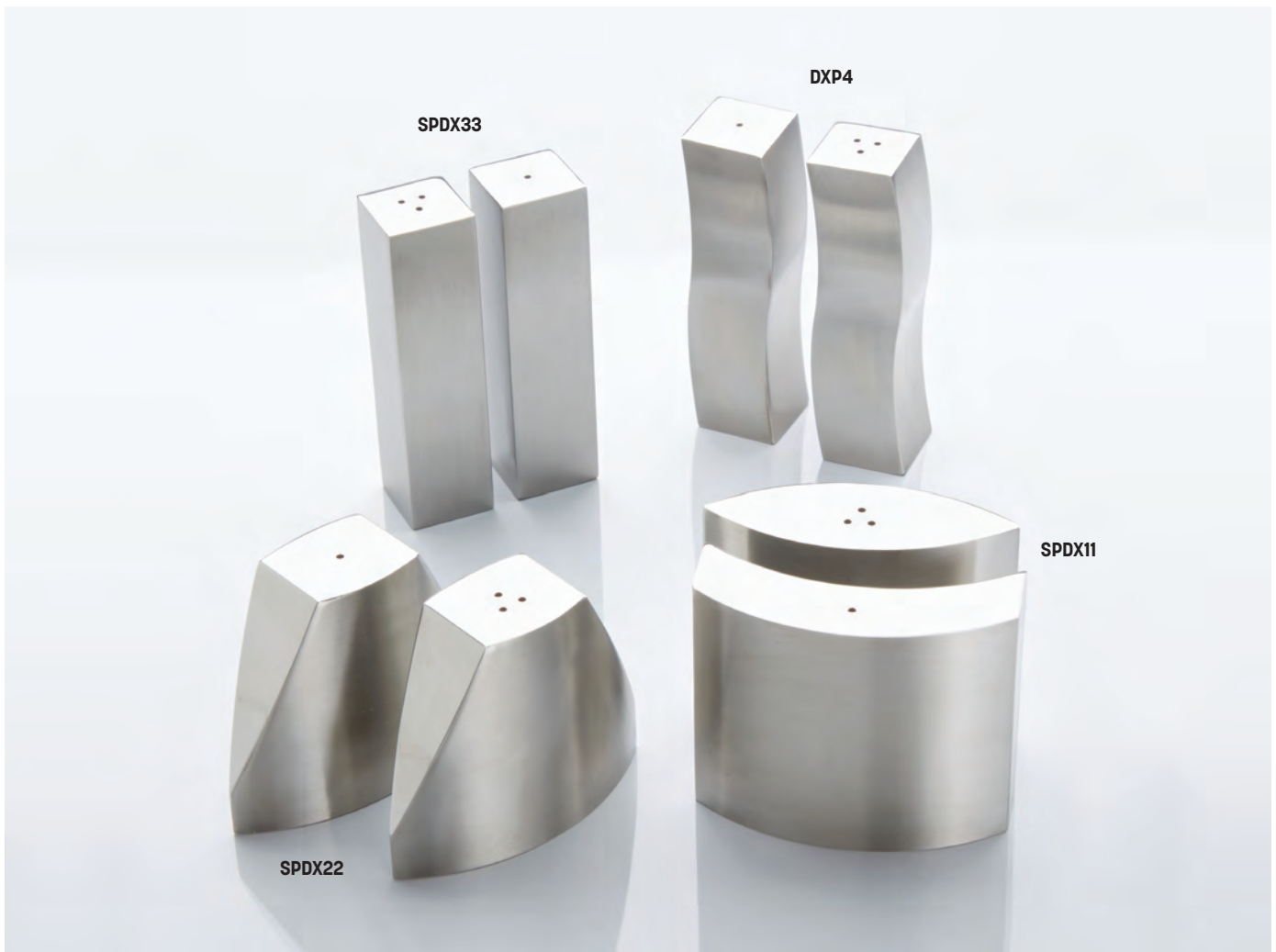

Modern Stainless Steel Salt & Pepper Shaker Sets

Choose from funky, whimsical styles in satin-finished stainless steel. Now available in black and gold options.

Silver

- SPDX33** 3 oz. (88.7 mL)
1" Sq. x 3 3/4" H
(2.5 x 9.5 cm)
- DXP4** 2 oz. (59.1 mL)
1" Sq. x 4" H
(2.5 x 10.2 cm)
- SPDX11** 4 oz. (118.3 mL)
3 1/8" L x 2 5/8" H
(7.9 x 6.7 cm)
- SPDX22** 3 oz. (88.7 mL)
3 1/4" W x 2 5/8" H
(8.3 x 6.7 cm)

Gold

- SPDG33** 3 oz. (88.7 mL)
1" Sq. x 3 3/4" H
(2.5 x 9.5 cm)
- SPDG11** 4 oz. (118.3 mL)
3 1/8" L x 2 5/8" H
(7.9 x 6.7 cm)

Black

- SPDB33** 3 oz. (88.7 mL)
1" Sq. x 3 3/4" H
(2.5 x 9.5 cm)
- SPDB11** 4 oz. (118.3 mL)
3 1/8" L x 2 5/8" H
(7.9 x 6.7 cm)
- SPPLUGS** Replacement Stoppers

Satin Finish Stainless Steel Salt & Pepper Shaker Set

A stainless steel set for the contemporary scene, these shakers deliver just the right amount of flash.

- SPM4** 3 oz. (88.7 mL)
1 3/4" Dia. x 4" H
(4.4 x 10.2 cm)

Brushed Stainless Steel Salt & Pepper Shaker Sets HOT

Give your tabletops a contemporary upgrade with these brushed stainless steel shakers.

- SP29** Round
1 oz. (29.6 mL)
3" H (7.6 cm)
- SP4** Rectangular
2 oz. (59.1 mL)
2 1/2" H (6.4 cm)
- SP35** Round
1 1/2 oz. (44.4 mL)
3 1/2" H (8.9 cm)
- SP6** Round with Caddy
1 oz. (29.6 mL)
3 1/4" H (8.3 cm)





Pepper Mills

Black Wood

- PMSBL62** Salt & Pepper Set
6" H (15.2 cm)
- PMBL8** Pepper Mill
8" H (20.3 cm)
- PMBL12** Pepper Mill
12" H (30.5 cm)
- PMKNOB** Replacement Screw

Bamboo

- PMSBA62** Salt & Pepper Set
6" H (15.2 cm)
- PMBA8** Pepper Mill
8" H (20.3 cm)
- PMBA12** Pepper Mill
12" H (30.5 cm)
- PMKNOB** Replacement Screw

Acrylic

- PMSA62** Salt & Pepper Set
6" H (15.2 cm)
- PMA8** Pepper Mill
8" H (20.3 cm)
- PMA12** Pepper Mill
12" H (30.5 cm)
- PMKNOB** Replacement Screw

Stainless Steel

- PMSS62** Salt & Pepper Set
6" H (15.2 cm)
- PMSS8** Pepper Mill
8" H (20.3 cm)
- PMSS12** Pepper Mill
12" H (30.5 cm)
- PMSKNOB** Replacement Screw

Red 

- PMSR62** Salt & Pepper Set
6" H (15.2 cm)
- PMR12** Pepper Mill
12" H (30.5 cm)
- PMKNOB** Replacement Screw

White Wood 

- PMSW62** Salt & Pepper Set
6" H (15.2 cm)
- PMW8** Pepper Mill
8" H (20.3 cm)
- PMW12** Pepper Mill
12" H (30.5 cm)
- PMKNOB** Replacement Screw

Mahogany

- WPMS62** Salt & Pepper Set
6" H (15.2 cm)
- WPM8** Pepper Mill
8" H (20.3 cm)
- WPM12** Pepper Mill
12" H (30.5 cm)
- WPM18** Pepper Mill
18" H (45.7 cm)
- WPMKNOB** Replacement Screw





DISPENSE SALT OR PEPPER WITH THE PUSH OF A BUTTON

PMG6



Shown with WB33 water bottle

USE WITH CLEAR ACRYLIC WATER BOTTLES ON PG. 332

PRS2

Presto-Push Salt & Pepper Mill

PMG6 6" H (15.2 cm)

Stainless Steel Salad Dressing Pourer

This easy-to-clean stainless steel pourer is a brilliant way to repurpose our Acrylic Water Bottles. Just fit the plastic cork into the neck and use the bottle to dispense salad dressing or oil. **Sold in a pack of 12.**

PRS2 Fits WB32, WB33, WB34, WB35
2" Dia. x 3 1/4" H (5.1 x 8.3 cm)

Oil & Vinegar Set

Classic glass bodies with stainless steel tops.

VWB26 Bottles, 6 oz. (177.4 mL)
2" Sq. x 6" H (5.1 x 15.2 cm)

VBR1 Chrome Oil and Vinegar Rack
5 1/4" L x 2 1/2" W x 9" H
(13.3 x 6.4 x 22.9 cm)

Oil & Vinegar Cruets

For something your customers have never seen before, these hand-blown glass designs feature an inner chamber for vinegar and an outer chamber for oil. An ideal accessory for keeping up with the gastronomic fad.

OVJ1 Inner Capacity, 2 oz. (59.1 mL)
Outer Capacity, 10 1/2 oz. (310.5 mL)
2 1/2" Dia. x 6 1/4" H (6.3 x 15.9 cm)

OVJ2 Inner Capacity, 3 oz. (88.7 mL)
Outer Capacity, 13 1/2 oz. (399.2 mL)
3 3/4" Dia. x 5 3/4" H (9.5 x 14.6 cm)

OVJS Replacement Stoppers



COMES COMPLETE WITH A CARRYING RACK

VBR1

VWB26



OVJ1

OVJ2

Mason Jar Sanitizer Pump

Easily and safely dispense hand sanitizer with this stainless steel sanitizer pump. Compatible with glass mason jars (MJ17, MJ85) and plastic mason jars (PMJ16, PMJ26). Jar sold separately.

MJP3 Mason Jar Lid with Pump
3" Dia. x 3" H (7.6 x 7.6 cm)

Plastic Sanitizer Dispensers

Serve up safety with these simple sanitizer dispensers. Made of clear polystyrene and topped with brushed stainless steel pumps, these reusable dispensers provide a fresh, unobtrusive way to keep hands clean. Sanitizer sold separately.

DPPS24 24 oz. (709.8 mL)
3" Sq. x 9 1/2" H
(7.6 x 24.1 cm)

DPRC17 17 oz. (502.8 mL)
2 1/4" L x 4 3/8" W x 8" H
(5.7 x 11.1 x 20.3 cm)

DPPR20 20 oz. (591.5 mL)
3 1/2" Dia. x 8 3/4" H
(8.9 x 22.2 cm)

DPS17 17 oz. (502.8 mL)
2 7/8" Sq. x 8" H
(7.3 x 20.3 cm)

Stainless Steel Sanitizer Dispensers

Sanitizing your hands has never looked so stylish. With a sleek and contemporary design, these refillable satin-finished stainless steel sanitizer dispensers serve as a welcome accessory to any counter or tabletop. Sanitizer sold separately.

DPSS16 16 oz. (473.2 mL)
3 1/2" Dia. x 5" H
(8.9 x 12.7 cm)

DPSS10 10 oz. (295.7 mL)
2" Dia. x 8 1/4" H
(5.1 x 21 cm)



Shown with MJ17 mason jar





Curved Wire Paper Towel Holders

A normally ordinary product made extraordinary with modern, unique styling.

PTCC Stainless Steel
7" Dia. x 13" H (17.8 x 33 cm)

PTBC Black
7" Dia. x 13" H (17.8 x 33 cm)

Contemporary Paper Towel Holders

Two classic table pieces in one smartly designed product.

PTCR Stainless Steel
7" Dia. x 13" H (17.8 x 33 cm)

PTBR Black
7" Dia. x 13" H (17.8 x 33 cm)

Wrought Iron Paper Towel Holder

Durable wrought iron meets a playful wavy design.

THN61 6" Dia. x 12" H (15.2 x 30.5 cm)

Straw Dispenser

Crafted from stainless steel and plastic, this retro straw dispenser is fun to look at and easy to use.

SD3511 3 ½" Dia. x 10 ¾" H (8.9 x 27.3 cm)

Cake Stand & Cover

Stand is constructed from bright-finished stainless steel. Cover is made of break-resistant heavy clear plastic. Shipped in three pieces.

19SET Base & Cover Set

19001 Stand Only
13 ½" Dia. x 7 ½" H (34.3 x 19.1 cm)

19004 Cover Only
12" Dia. x 6" H (30.5 x 15.3 cm)

Stainless Steel Snail Plate, Tong and Fork

SNF700 Snail Fork
7" L (17.8 cm)

SN60 Six-Compartment Plate

SNT612 Satin Finish Snail Tong

Lobster/Nut Crackers

LNC602 Cast Iron, 6 ¾" L (16.2 cm)

LN722 Chrome, 6 ¾" L (16.2 cm)





Stainless Steel Au Gratin Dishes

In seven sizes, these serving dishes feature timeless design and subtle metalwork.

Round

- AR060** 6 oz. (177.4 mL)
6 ¾" Dia. x 5 ½" Top ID (14.9 x 12.7 cm)
- AR080** 8 oz. (236.6 mL)
7 ¼" Dia. x 5 ⅝" Top ID (17 x 14.6 cm)
- AR100** 10 oz. (295.7 mL)
6 ⅞" Dia. x 6" Top ID (20.3 x 16.2 cm)

Oval

- A0080** 8 oz. (236.6 mL)
8" L x 4 ½" W x 1" H (20.3 x 11.4 x 2.5 cm)
- A0120** 12 oz. (354.9 mL)
9" L x 5" W x 1" H (22.9 x 12.7 x 2.5 cm)
- A0150** 15 oz. (443.6 mL)
10" L x 5" W x 1" H (25.4 x 12.7 x 2.5 cm)
- A0200** 20 oz. (591.5 mL)
11" L x 6" W x 1" H (27.9 x 15.2 x 2.5 cm)

Footed Sherbet Dishes

These stainless steel dishes bring an ice cream parlor aesthetic to any table they touch.

- 3500** 3 ½ oz. (103.5 mL)
3 ¾" Dia. x 1 ⅜" H (9.5 x 3.5 cm)
- 5000** 5 oz. (147.9 mL)
4 ¼" Dia. x 1 ¾" H (10.8 x 4.5 cm)
- 9000** 9 oz. (266.2 mL)
5 ⅜" Dia. x 2 ½" H (13.7 x 6.4 cm)



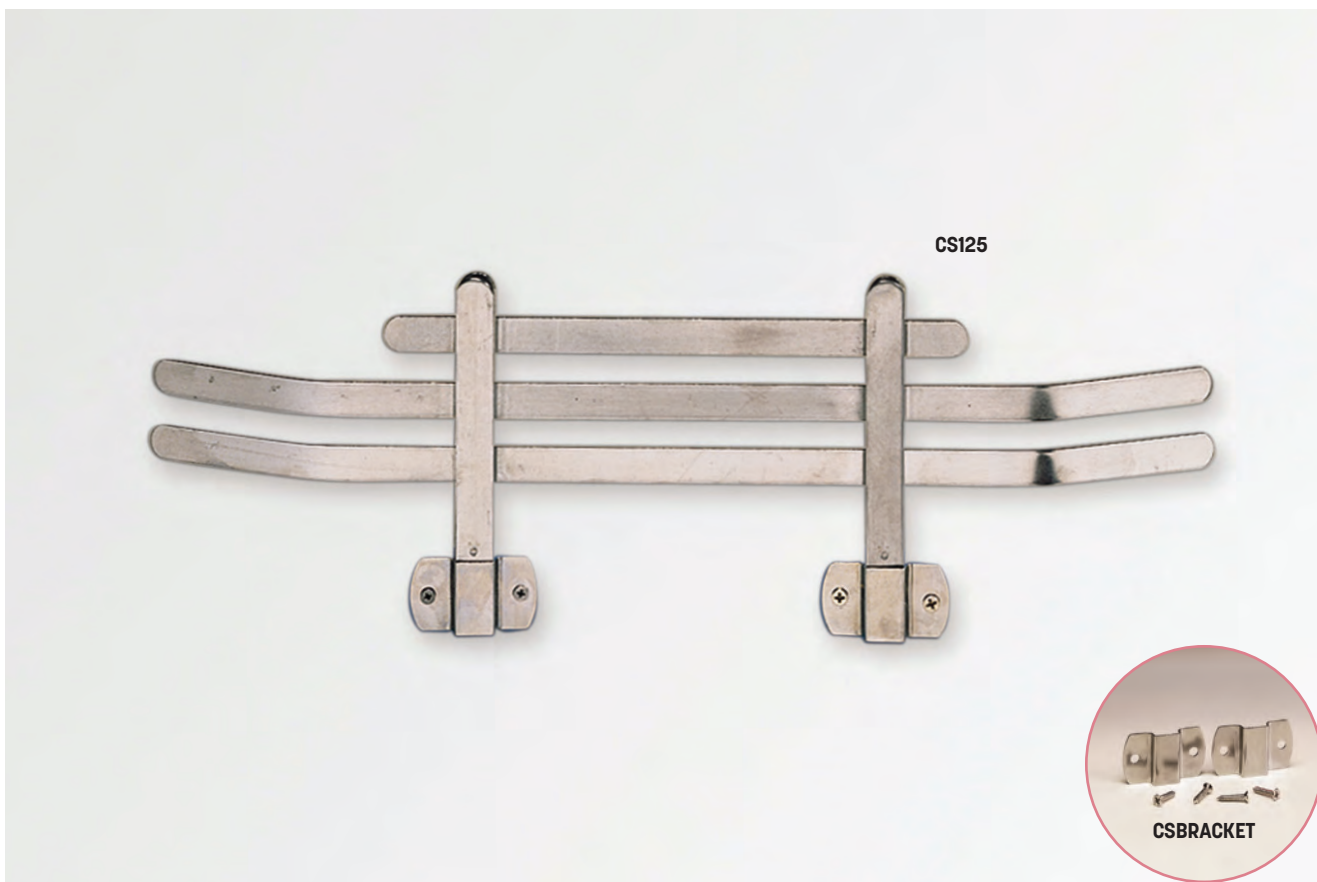

Counter Setup and Menu Holder

Polished heavy-gauge stainless steel. Screws and bracket included.

CS125 Holder
15 1/2" L x 5" H (39.4 x 12.7 cm)

CSBRACKET Extra Brackets and Screws

Butter Warmers

BWR34 Ceramic Ramekin
4 oz. (118.3 mL)
Stand
3 1/4" Dia. x 3 7/8" H (8.3 x 9.8 cm)

RAM1 Replacement
4 oz. (118.3 mL)
Ramekin for BWR34

BWPC35 Stainless Cup
3 1/2 oz. (103.5 mL)
Stand
3 1/4" Dia. x 5 1/4" H (8.3 x 13.3 cm)



AVAILABLE IN TWO SIZES AND
IN THREE COLORS



WTSM31

WTSW32

WTSB33



HOT

CTS31

TRSD1815

Wood Tray Stands

Your servers will appreciate that these elegant tray stands open with one hand, fold for easy storage and hold heavy loads. Featuring nylon straps and real wood.

Mahogany

WTSM31 17" W x 31" H (43.2 x 78.7 cm)

WTSM38 18" W x 38" H (45.7 x 96.5 cm)
(not shown)

Walnut

WTSW32 17" W x 31" H (43.2 x 78.7 cm)

WTSW39 18" W x 38" H (45.7 x 96.5 cm)
(not shown)

Black Finish

WTSB33 17" W x 31" H (43.2 x 78.7 cm)

WTSB40 18" W x 38" H (45.7 x 96.5 cm)
(not shown)

Deluxe Metal Tray Stands HOT

Choose from polished chrome or black chrome plate tubular steel with black nylon straps. Black plastic feet prevent damage to floors.

CTS31 Black Chrome
19" L x 15 5/8" W x 31" H
(48.3 x 39.7 x 78.7 cm)

TRSD1815 Polished Chrome
19" L x 15 5/8" W x 31" H
(48.3 x 39.7 x 78.7 cm)



FITS OVER 27" OVAL TRAYS
AND INSIDE 29" OVAL TRAYS

ATCU

Antimicrobial Oval Tray Cover

Protect an entire tray of food with just one cover. Ingeniously designed to work with the most popular 27" and 29" oval serving trays, this cover helps deliver food safely from kitchen to table while keeping meals warm and free from contaminants. Made of antimicrobial, dishwasher-safe ABS plastic, this cover not only minimizes germs on its surface but also can be safely sanitized after use. The ideal companion for any server.

ATCU 27 7/8" L x 22 1/2" W x 5 5/8" H
(70.8 x 57.2 x 14.3 cm)

Plastic Plate Cover HOT

Made of durable and dishwasher-safe ABS plastic, this plate cover provides full coverage (no finger or steam hole) for safely delivering food to the table. Universal crown on top of cover allows for quick and easy stacking while innovative inside sizing system allows for fit on plates 10 to 11 1/2" (25.4 to 29.2 cm) in diameter.

APCU 11 7/8" Dia. x 2 7/8" H
(30.2 x 7.3 cm)



HOT

APCU

Shown with MCBPBSS bill presenter and
PORSD3R sauce dish

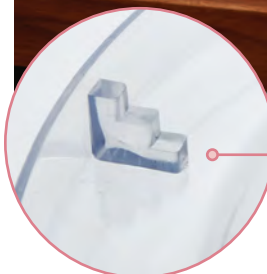

CAN COVER AND STACK ON PLATES
10 TO 11 1/2" IN DIAMETER



STANDARD STOCKED PLATE COVERS

Need to please a crowd in a pinch? Our most popular plate covers are now available for rapid turnaround. Made of durable satin-finished stainless steel, these covers feature top-of-the-line heat retention and odor resistance. A well in the top of each cover fits the foot of many different plates. Just measure the diameter of the plate and note the design of the foot to determine the best option. We can also help guide you to the right cover choice with key details about the plate (manufacturer, model and/or size) or by sending a sample plate. All covers are 2" in height and include a finger hole. For help ordering, call 800-333-9133 or email platecovers@amnow.com.





Round Standard Stocked Stainless Steel Plate Covers HOT

- NEW **PC0825S** Fits plates 8 1/16" to 8 1/4" Dia. (20.5 to 21 cm) with Standard or Wide Foot
- NEW **PC0875S** Fits plates 8 3/8" to 8 1/2" Dia. (21.3 to 22.4 cm) with Standard or Wide Foot
- NEW **PC0900S** Fits plates 8 15/16" to 9 1/8" Dia. (22.7 to 23.2 cm) with Standard or Wide Foot
- PC0950R** Fits plates 9 1/4" to 9 1/2" Dia. (23.5 to 24.1 cm) with Standard Foot
- PC0988S** Fits plates 9 5/8" to 9 7/8" Dia. (24.4 to 25.1 cm) with Standard or English-Style Foot
- PC1025S** Fits plates 10" to 10 1/4" Dia. (25.4 to 26 cm) with Standard or English-Style Foot
- PC1062E** Fits plates 10 3/8" to 10 5/8" Dia. (26.4 to 27 cm) with English-Style or Wide Foot
- PC1068R** Fits plates 10 3/8" to 10 5/8" Dia. (26.4 to 27 cm) with Standard or Narrow Foot
- PC1093R** Fits plates 10 1/2" to 10 7/8" Dia. (26.7 to 27.6 cm) with Standard or Narrow Foot
- PC1093E** Fits plates 10 1/2" to 10 7/8" Dia. (26.7 to 27.6 cm) with English-Style or Wide Foot
- PC1112S** Fits plates 11" to 11 1/8" Dia. (27.9 to 28.3 cm) with Standard or Wide Foot
- PC1112R** Fits plates 11" to 11 1/8" Dia. (27.9 to 28.3 cm) with Standard or Narrow Foot

- PC1150S** Fits plates 11 1/8" to 11 1/2" Dia. (28.3 to 29.2 cm) with Standard or English-Style Foot
- PC1175R** Fits plates 11 5/8" to 11 3/4" Dia. (29.5 to 29.8 cm) with Standard Foot
- PC1206R** Fits plates 11 13/16" to 12 1/16" Dia. (30 to 30.6 cm) with Standard Foot
- NEW **PC1244R** Fits plates 12 1/8" to 12 7/16" Dia. (30.8 to 31.6 cm) with Standard Foot
- NEW **PC1250S** Fits plates 12 3/16" to 12 9/16" Dia. (31 to 31.9 cm) with Standard, Narrow or Wide Foot



STOCKED AND READY TO SHIP



CUSTOM PLATE COVERS

For more information or to receive a quote, call 800.333.9133 or email platecovers@amnow.com. Sample of plate may be required for evaluation.

Plate Cover Cart

Aluminum base with five casters. Comes with a steel screw-in bar. Holds up to 175 covers.

SCRACK5 40 ¼" H x 20" Dia. Overall
 (102.2 x 50.8 cm)
 Pole 37 ¼" H x 5/8" Dia.
 (94.6 x 1.6 cm)
 Base 4" H (10.2 cm)

Condiment or Relish Jar Covers

Stainless steel with a deluxe finish. Comes with a heavy riveted stainless knob. Slotted to accommodate dauber spoon.

RD412 Standard size
 3 ½" ID (7.94 cm)



RD412

Buffet & Display





SLOW-RELEASE GLASS LID

REVLRD20 shown with REVLRD20BASE

INCLUDES A CONVENIENT SPOON HOLDER

THE EVOLUTION™ COLLECTION

The sharpest, most contemporary designs in the restaurant world need not be limited to the dinner table. The Evolution Collection from American Metalcraft features simple, elegant designs in stainless steel for today's buffets.

Evolution Round Chafer

Chafer features an induction base and comes complete with a stainless steel spoon holder. Stand sold separately.

REVLRD20 7 qt. (6.6 L)
20 ½" L x 20" W x 12" H
(52.1 x 50.8 x 30.5 cm)

Note: For use on induction units greater than 1800 watts.

Replacement Parts

REVLRD20BASE Stand with Fuel Holder
14 ½" L x 17" W x 5 ¾" H
(36.8 x 43.2 x 14.6 cm)

CSR26 Spoon Holder

RFP18RD Round Food Pan

Evolution Rectangular Chafer

Chafer features an induction base and comes complete with a stainless steel spoon holder. Stand sold separately.

REVLRT26 9 qt. (8.5 L)
26" L x 18" W x 12" H
(66 x 45.7 x 30.5 cm)

Note: For use on induction units greater than 1800 watts.

Replacement Parts

REVLRT26BASE Stand with Fuel Holders
22" L x 16" W x 5 ¾" H
(55.9 x 40.6 x 14.6 cm)

CSR26 Spoon Holder

CDFP88 Rectangular Food Pan



REVLRT26 shown with REVLRT26BASE



REVLJUICESQ12



REVLOSCU12

Evolution Juice Dispenser

Give brunch a dose of elegance. The polycarbonate body features an offset ice reservoir for easier dispensing and refilling. Legs, lid and frame crafted from sleek stainless steel.

REVLJUICESQ12 12 qt. (11.4 L)
 11" L x 12" W x 23 1/8" H
 (27.9 x 30.5 x 58.7 cm)



Replacement Parts

- JFAUC8** Faucet
- JTUBE6** Stainless Steel Ice Tube
- JCOV6** Stainless Steel Cover
- JREP6** Polycarbonate Body



Evolution Coffee Urn

A simple, futuristic design makes this all-stainless steel piece shine. With high-quality faucet and fuel holder.

REVLOSCU12 12 qt. (11.4 L)
 11" L x 13 3/8" W x 21 1/4" H
 (27.9 x 34 x 54 cm)

Replacement Parts

- AFAUC1** Faucet

WARNING: This product can expose you to chemicals including Bisphenol A (BPA), which is known to the State of California to cause birth defects or other reproductive harm. For more information, go to <http://www.P65warnings.ca.gov>. Warning applies to State of California only.

Evolution Beverage Urn

Serve ice-cold juice by day and piping-hot coffee by night with this versatile stainless steel urn. Includes a fuel holder and ice reservoir.

REVLURN12 12 qt. (11.4 L)
 10 1/4" L x 12 5/8" W x 20 7/8" H
 (26 x 32.1 x 53 cm)

Replacement Parts

- AFAUC1** Faucet

Drip Trays

These stainless steel drip trays keep buffet space clean without sacrificing aesthetics.

- DT3** 5 1/2" Dia. x 1/2" H
(14 x 1.3 cm)
- DT4** 6" Sq. x 1/2" H
(15.2 x 1.3 cm)

REVLURN12 shown with MICH25 and MICH5 milk cans



COMPLETE THE LOOK WITH EVOLUTION CREAMERS ON PG.105



DT3



DT4

OUR MESA COLLECTION LENDS CLASSIC STYLE TO ALL KINDS OF BUFFETS

MESA19

MESA27

MESABUSS13



THE MESA™ COLLECTION

Equally elegant and eye-catching, the Mesa Collection is a fabulous way to make your buffet service memorable. Featuring a classic combination of wrought iron and hammered copper or stainless steel, each of these items works independently or as a cohesive collection.

Mesa Stainless Steel Roll-Top Chafers

These 180° roll-top chafers are adorned with beautiful wrought iron trim and convenient built-in spoon holders. A locking mechanism allows the lid to remain open at 90° for stunning presentation. Each chafers comes with a 22-gauge food pan, water pan, fuel holder and spoon.

MESA19 Round
6 qt. (5.7 L)
19 1/2" L x 21" W x 19 1/2" H
(49.3 x 53.3 x 49.3 cm)

MESA27 Rectangular
8 qt. (7.6 L)
27 1/8" L x 21 1/4" W x 19 1/2" H
(68.9 x 54 x 49.3 cm)

Replacement Parts for Mesa Chafers

CDFP44 Round Food Pan
CDWPM19 Round Water Pan
CDFP33 Rectangular Food Pan
CDWPM27 Rectangular Water Pan
CUP1 Stainless Steel Spoon Holder

Mesa Coffee Urns

The most stylish way to serve hot beverages, this new addition to our Mesa Collection is designed to be paired with our Mesa Roll-Top Chafers.

Stainless Steel

MESABUSS13 13 qt. (12.3 L)
14 1/8" Dia. x 23 1/2" H
(35.9 x 60.1 cm)

Hammered

MESABUSH13 13 qt. (12.3 L)
14 1/8" Dia. x 23 1/2" H
(35.9 x 60.1 cm)

Copper

MESABUCH13 13 qt. (12.3 L)
14 1/8" Dia. x 23 1/2" H
(35.9 x 60.1 cm)

Replacement Parts for Mesa Coffee Urns

AFAUC1 Faucet

MESABUSH13



MESABUCH13



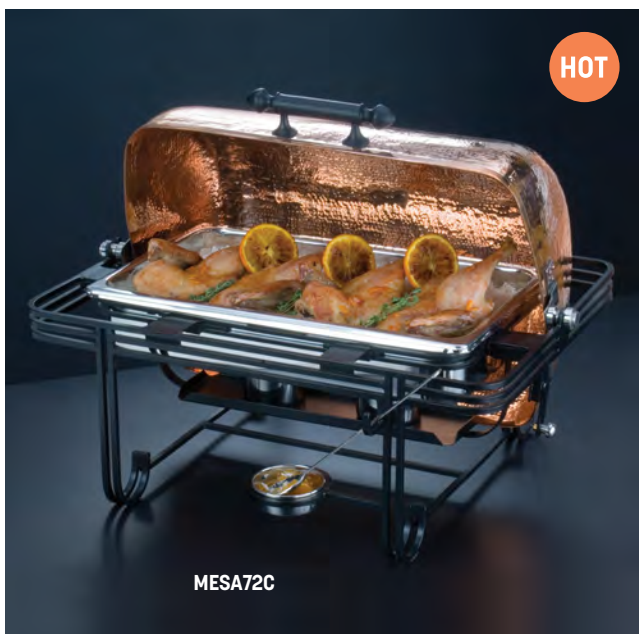

MESA72C



MESA72H



MESA91C



MESA91H

Mesa Hammered Copper Roll-Top Chafers HOT 🔥

MESA91C Round
6 qt. (5.7 L)
19 1/2" L x 21" W x 19 1/2" H
(49.3 x 53.3 x 49.3 cm)

MESA72C Rectangular
8 qt. (7.6 L)
27 1/8" L x 21 1/4" W x 19 1/2" H
(68.9 x 54 x 49.3 cm)

Mesa Hammered Stainless Steel Roll-Top Chafers

MESA91H Round
6 qt. (5.7 L)
19 1/2" L x 21" W x 19 1/2" H
(49.3 x 53.3 x 49.3 cm)

MESA72H Rectangular
8 qt. (7.6 L)
27 1/8" L x 21 1/4" W x 19 1/2" H
(68.9 x 54 x 49.3 cm)



HYDRAULIC
HINGE FOR
EASY OPENING

ADAGIORT26



ADAGIORD18



GOLDAGR18



GOLDAGR26



MACD3

Adagio™ Chafers

These stainless steel roll-top chafers can be kept open at any angle. Choose the gold-handled option for an extra luxe flair. Comes complete with a food pan, water pan and fuel holder(s).

Silver-Handled

ADAGIORD18 Round, 7 qt. (6.6 L)
18" L x 18 1/2" W x 18" H
(45.7 x 47 x 45.7 cm)

ADAGIORT26 Rectangular, 9 qt. (8.5 L)
26 1/2" L x 19 1/2" W x 17 1/2" H
(67.3 x 49.3 x 44.5 cm)

Gold-Handled

GOLDAGR18 Round, 7 qt. (6.6 L)
18" L x 18 1/2" W x 18" H
(45.7 x 47 x 45.7 cm)

GOLDAGR26 Rectangular, 9 qt. (8.5 L)
26 1/2" L x 19 1/2" W x 17 1/2" H
(67.3 x 49.3 x 44.5 cm)

Replacement Parts

RFP18RD	Round Food Pan
CDWP18	Round Water Pan
CDFP88	Rectangular Food Pan
CDWP26	Rectangular Water Pan

Applause™ Chafer

Your crowds will go wild over the satin-finished stainless steel, 90° roll-top rectangular chafer. Comes with standard water pan, food pan and two fuel holders.

MACD3 8 qt. (7.6 L)
24 1/2" L x 13 3/4" W x 15 1/4" H
(62.2 x 37.9 x 38.7 cm)

Replacement Parts

MACTOP	Lid
---------------	-----

Chafers Frames

All frames fit standard-sized chafers pans and feature slots for fuel holders. Choose the ornate option for extra style and functionality with spoon holders and side handles. Chafers kits sold separately.

Stackable

SCF2 Wrought Iron Full-Size Frame
24 1/2" L x 16 1/2" W x 8 1/4" H
(62.2 x 41.9 x 21 cm)

Ornate

CF1 Wrought Iron Full-Size Frame & Cup
24" L x 13" W x 11" H
(61 x 33 x 27.9 cm)

Chafers Frame Accessories

CFKIT Food Pan, Water Pan, Lid, Fuel Holders

CUP1 Stainless Steel Spoon Holder

CDFP55 Food Pan

CDWP66 Water Pan

CDCV77 Lid

Fuel Holder

FH1 Stainless Steel
3 3/4" Dia. x 2 1/2" H, 6 3/4" with Handle
(9.5 x 6.4, 17.1 cm)

Adapter Bars

For dividing water pans into sections.

AB131 12 1/2" L (31.8 cm)

AB211 20 1/2" L (52.1 cm)

Stackable Storage Crate

This large container is especially practical for back-of-house storage. See amnow.com for fit options.

SCBL 21 1/4" L x 17 5/8" W x 18 1/8" H
(54 x 44.8 x 46 cm)



SCF2 shown with CFKIT

STACKABILITY MAKES STORAGE A CINCH



CF1 shown with CFKIT and SSP120 spoon

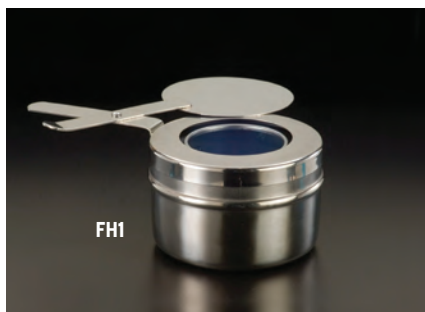

FH1



AB211

AB131

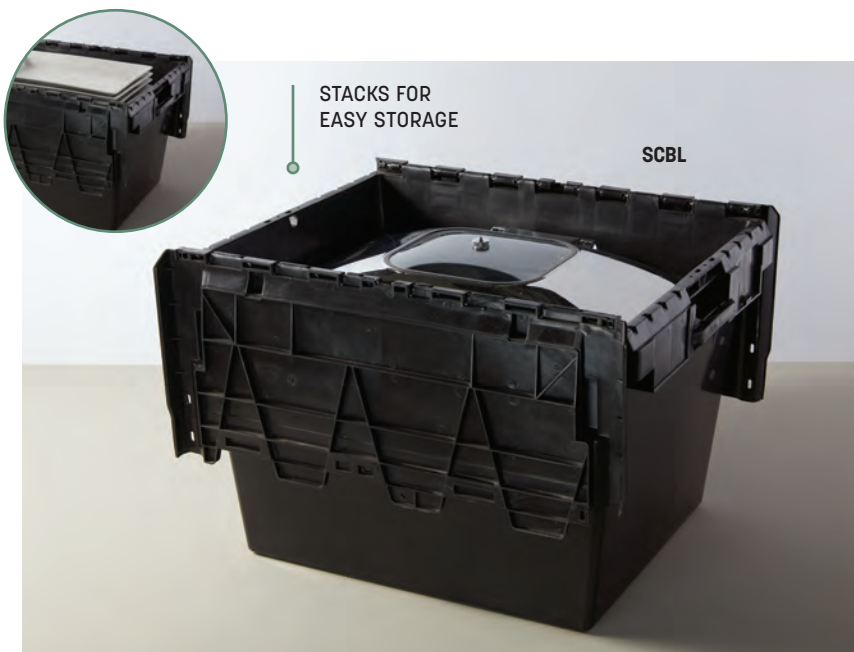

STACKS FOR EASY STORAGE

SCBL

Shown with CFKIT Chafer Kit, SVHSP solid spoon, WLD15 porcelain platter and PMSS62 S&P set

USE AS A CHAFER WITH FULL-SIZE FOOD PANS

KBC10 shown with IBT125 insert



Folding Beverage Frames

Upgrade buffets in an instant with these collapsible frames. Use with food pans or beverage inserts, and then fold and stack for easy storage. In your choice of size and style.

Black Twilight Crates

- KBC6** 1/6-Size
6 1/4" L x 5 3/4" W x 6 1/2" H
(15.9 x 14.6 x 16.5 cm)
- KBC12** 1/3-Size
12" L x 6 1/8" W x 6 3/8" H
(30.5 x 15.6 x 16.2 cm)
- KBC10** Half-Size
12 1/8" L x 10" W x 8 1/8" H
(30.8 x 25.4 x 20.6 cm)
- KBC20** Full-Size
20 3/8" L x 12 3/8" W x 8 1/4" H
(51.8 x 31.4 x 21 cm)

Stainless Steel Milk Crates

- KSMC6** 1/6-Size
6 1/4" L x 5 3/4" W x 6 1/2" H
(15.9 x 14.6 x 16.5 cm)
- KSMC12** 1/3-Size
12" L x 6 1/8" W x 6 3/8" H
(30.5 x 15.6 x 16.2 cm)
- KSMC10** Half-Size
12 1/8" L x 10" W x 8 1/8" H
(30.8 x 25.4 x 20.6 cm)
- KSMC20** Full-Size
20 3/8" L x 12 3/8" W x 8 1/4" H
(51.8 x 31.4 x 21 cm)



Shown with G30, G21 and G17 griddles, BLHT1 and BLHT2 tongs, and MPL8 mini pots



Black Twilight Griddle Stands

Elevate your brunch presentation with this trio of griddle stands. All three are crafted from iron so they can stand the heat in style. Tapered for easy storage.

- GSC16** Half-Size
16" L x 8" W x 4 1/2" H
(40.6 x 20.3 x 11.4 cm)
- GSC17** Round
17" Dia. x 4 1/2" H
(43.2 x 11.4 cm)
- GSC26** Full-Size
26 1/4" L x 14" W x 4 1/2" H
(66.7 x 35.6 x 11.4 cm)

Black Twilight Market Trays

Give your deli case an easy, stylish upgrade. A striking angular design gives these dishwasher-safe market trays a contemporary flair.

- MTB156** Rectangular
15" L x 6" W x 2" H
(38.1 x 15.2 x 5.1 cm)
- MTB159** Rectangular
15" L x 9" W x 2" H
(38.1 x 22.9 x 5.1 cm)
- MTB1512** Rectangular
15" L x 12" W x 2" H
(38.1 x 30.5 x 5.1 cm)
- SBBL** Rectangular
16 3/8" L x 8 1/4" W x 2" H
(41.6 x 21 x 5.1 cm)
- SBBS** Square
8 1/8" Sq. x 2" H
(20.6 x 5.1 cm)



Shown with COLDB cold cell and POR9 bowl



G30 shown on
GSST2514 stand

G17 shown on
GSSS20 stand

Marinated
Vegetables



G30

HAMMERED STAINLESS STEEL GRIDDLES AND STANDS

These gorgeous pieces lend a sparkling touch to any buffet. Each of these warming griddles is individually hammered, making no two alike. Pair them with matching contemporary stainless steel stands to complete the exquisite look.

Large Rectangular Griddle and Stand

G30 Griddle
30 3/4" L x 16 1/4" W x 1 3/4" H
(78.2 x 41.3 x 1.5 cm)

GSST2514 Stand
26 1/4" L x 14" W x 4 1/4" H
(66.7 x 35.6 x 10.8 cm)

Round Griddle and Stand

G17 Griddle
18" Dia. x 2" H
(45.7 x 5.1 cm)

GSSS20 Stand
17" Dia. x 4 1/4" H
(43.2 x 10.8 cm)



G17



Oval Griddle and Stand

G23 Griddle
23 3/4" L x 13 3/4" W x 1 3/4" H
(60.3 x 34.9 x 1.5 cm)

GSOVL Stand
20" L x 14" W x 4 3/4" H
(50.8 x 35.6 x 12.1 cm)

Small Rectangular Griddle and Stand

G21 Griddle
21 3/4" L x 9" W x 1 1/2" H
(55.2 x 22.9 x 3.8 cm)

GSREC Stand
17 1/4" L x 9 1/4" W x 5" H
(43.8 x 23.5 x 12.7 cm)

Paella Pan and Stand

GP21 Paella Pan
21 3/4" Dia. x 4 3/4" H
(55.2 x 12.1 cm)

GSSS20 Stand
17" Dia. x 4 1/4" H
(43.2 x 10.8 cm)





GSST17 shown with GSSS20 stand

Stainless Steel Griddles and Stands

Round Griddle and Stand

GSST17 Griddle
17 1/2" Dia. x 2 1/8" H
(44.5 x 5.4 cm)

GSSS20 Stand
17" Dia. x 4 1/4" H
(43.2 x 10.8 cm)

Rectangular Griddle and Stand

GSSS1526 Griddle
32 5/8" L x 16 1/2" W x 2 1/8" H
(82.9 x 41.9 x 5.4 cm)

GSST2514 Stand
26 1/4" L x 14" W x 4 1/4" H
(66.7 x 35.6 x 10.8 cm)

Flat Coil Fuel Holder

WIFH2 3 3/4" Dia. x 2 3/8" H
6 3/4" L with Handle
(9.5 x 6.3, 17.1 cm)

Flame Guards

FGRS7 6 7/8" Dia. x 3 1/2" H
(17.5 x 8.9 cm)

FGRS10 10" Dia. x 3 1/2" H
(25.4 x 8.9 cm)



GSSS1526 shown with GSST2514 stand



FGRS10 shown with GSSS1526 griddle and GSST2514 stand

FGRS7 shown with GS1775 paella pan and GSS17 stand

LASER-CUT FLAMES EMBELLISH THESE BRUSHED STAINLESS STEEL GUARDS THAT PROTECT FUEL CANS FROM WIND



GS1775 shown with
GSS17 stand and
WIFH2 fuel holder

Wrought Iron Griddles and Stands

These griddles and stands are perfect for self-served breakfast, Mexican-inspired fare, tempting desserts and more.

Round Paella Pan and Stand

GS1775 Paella Pan
21 3/4" Dia. x 4 3/4" H
(55.3 x 12 cm)

GSS17 Stand
17" Dia. x 4 1/4" H
(43.2 x 10.8 cm)

Round Griddle and Stand

GS18 Round Griddle with Stand
18" Dia. x 4 1/4" H
(45.7 x 10.8 cm)

GS81 Griddle
18" Dia. x 1" H
(45.7 x 2.5 cm)

GSS17 Stand
17" Dia. x 4 1/4" H
(43.2 x 10.8 cm)

Rectangular Griddles and Stands

GS27 Full-Size Griddle with Stand
27" L x 16" W x 5" H
(68.6 x 40.6 x 12.7 cm)

GS16 Half-Size Griddle with Stand (not shown)
16" L x 13 1/2" W x 5" H
(40.6 x 34.3 x 12.7 cm)

G72 Full-Size Griddle
27" L x 16" W x 1" H
(68.6 x 40.6 x 2.5 cm)

G61 Half-Size Griddle (not shown)
16" L x 13 1/2" W x 1" H
(40.6 x 34.3 x 2.5 cm)



GS18 shown with
WIFH2 fuel holder



GS27



Ultra-Chill Cold Cell

Keep food colder for longer. These cells freeze at 10° F and maintain cold temperatures up to four hours. Recharge in freezer for 24 hours.*

COLD8 8" Sq. x 1 7/8" H
(20.3 x 4.8 cm)

CAST IRON

Heavy-duty cast iron goes straight from oven to table and looks great at stations and buffets. In a variety of styles and sizes to accommodate the trendy rustic look.

Cast Iron Griddles

No kitchen is complete without a cast iron griddle, and the handles on this piece also make it ideal for easy buffet service. Check out amnow.com for pairing options.

CIG17 Half-Size Griddle
18 1/4" L x 10" W x 1 1/4" H
20 3/4" with Handles
(46.4 x 25.4 x 3.2, 52.7 cm)

CIG26 Full-Size Griddle
25 1/2" L x 14 1/2" W x 1 1/4" H
28 1/8" with Handles
(64.8 x 36.8 x 3.2, 71.4 cm)

COLD CELL MUST MAINTAIN SURFACE-TO-SURFACE CONTACT FOR BEST PERFORMANCE

COLD8 shown with SBS crate



TWO SURFACES IN ONE!

CIG26

CIG17

Shown with WIFH2 fuel holders, GSST2514 stand, CP7CL coupe plates, SBL crate and TGS9 tongs

*The performance of the cold cell will vary based on food types, environmental temperature and humidity and other external variables.

Round Cast Iron Fry Pans

- CIS8** 48 oz. (1.4 L)
8" Dia. x 2 ¼" H
13 ¾" L with Handle
(20.3 x 5.7, 35 cm)
- CIS10** 64 oz. (1.9 L)
10" Dia. x 2 ¼" H
15 ¾" L with Handle
(25.4 x 5.7, 40 cm)
- CIS12** 96 oz. (2.8 L)
12" Dia. x 2 ¼" H
19" L with Handle
(30.5 x 5.7, 48.3 cm)
- CIS14** 128 oz. (3.8 L)
14" Dia. x 3 ½" H
20" L with Handle
(35.6 x 8.9, 50.8 cm)

Large Cast Iron Casseroles

- CIP03** 96 oz. (2.8 L)
10 ⅝" L x 8 ⅞" W x 4 ½" H
12 ½" L with Handles, 6 ½" H with Knob
(27 x 20.6 x 11.4, 31.8, 16.5 cm)
- CIP04** 128 oz. (3.8 L)
11 ⅝" L x 8 ⅞" W x 4 ½" H
14" L with Handles, 6 ½" H with Knob
(29.5 x 21 x 11.4, 35.6, 16.5 cm)
- CIPR3** 96 oz. (2.8 L)
8 ¾" Dia. x 4" H
11 ¼" L with Handles, 6" H with Knob
(22.2 x 10.2, 28.6, 15.2 cm)
(not shown)
- CIPR4** 128 oz. (3.8 L)
9 ½" Dia. x 4 ¼" H
12" L with Handles, 6 ½" H with Knob
(24.1 x 10.8, 30.5, 16.5 cm)
(not shown)

Large Silicone Trivets

- TRVR8** Round
8" Dia. x ¼" H
(20.3 x 0.6 cm)
- TRVR10** Round
10" Dia. x ¼" H
(25.4 x 0.6 cm)



Mix-and-Match Juice Dispensers

These pieces are all stylishly interchangeable. Just choose a body and a base, and create a unique look that's as refreshing as the beverages you're serving. Bodies come complete with faucet, cover, ice tube and insert.

STEP 1
Pick a Body Size

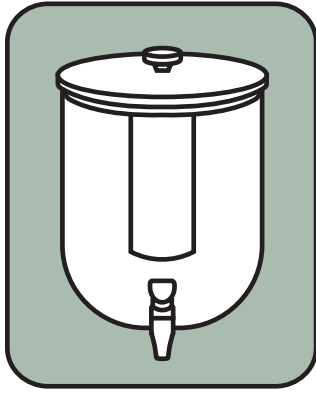

+

STEP 2
Pick a Base.

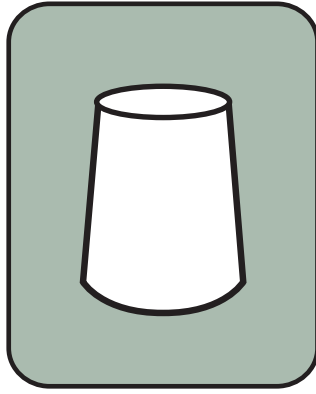

=

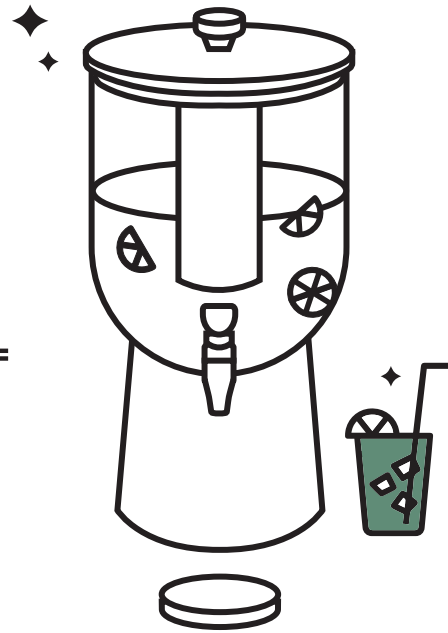



Plastic Dispenser Bodies

JUICE3 Body, 12 qt. (11.3 L)
11" L x 10 1/4" W x 13 1/2" H
(27.9 x 26 x 34.3 cm)

JUICE4 Body, 20 qt. (18.9 L)
12 1/2" L x 12" W x 20 1/2" H
(31.8 x 30.5 x 52.1 cm)

Dispenser Bases

JBASE1 Hammered Stainless Steel Base
8" Dia. x 7 3/4" H (20.3 x 19.7 cm)

JBASE2 Wrought Iron Juice Base
8" Dia. x 8" H (20.3 x 20.3 cm)

JBASE3 Silver Galvanized Base
8" Dia. x 7 3/4" H (20.3 x 19.7 cm)

JBASE4 Onyx Galvanized Base
8" Dia. x 7 3/4" H (20.3 x 19.7 cm)

JBASE5 Black Twilight Base
8" Dia. x 8" H (20.3 x 20.3 cm)

JBASE6 Black Twilight Base
9" Dia. x 12" H (20.3 x 30.5 cm)

JBASE7 Hammered Stainless Steel Base
9" Dia. x 12" H (20.3 x 30.5 cm)

CCB7 Black Terra Ceramic Base
7 3/8" Dia. x 8" H (18.7 x 20.3 cm)

CCW7 White Terra Ceramic Base
7 3/8" Dia. x 8" H (18.7 x 20.3 cm)

Replacement Parts for JUICE3

JFAUC5 Faucet

JCOV3 Stainless Steel Cover

JTUBE3 Stainless Steel Ice Tube with Inset

JREP4 Plastic Body with Faucet

Replacement Parts for JUICE4

JFAUC5 Faucet

JCOV4 Stainless Steel Cover

JTUBE4 Stainless Steel Ice Tube with Inset

JREP5 Plastic Body with Faucet





Dual Juice Dispenser ⚠

This clever, doubly functional piece comes complete with polycarbonate body, faucets, cover, ice tubes and grated base.

JUICE12 Dispensers (2) 5.3 qt. (5 L)
17" L x 13 1/2" W x 21" H
(43.2 x 34.3 x 53.3 cm)

Replacement Parts

- JFAUC8** Faucet
- JSTRN12** Strainer
- JCOV12** Cover
- JTUBE12** Dual Ice Tubes
- JBOD12** Dual Polycarbonate Bodies



Mini Juice Dispenser ⚠ ⚠

Comes complete with polycarbonate body, faucet, cover, ice tube and grated base.

JUICE5 Dispenser, 5.3 qt. (5 L)
16" L x 9" W x 14" H
(40.6 x 22.9 x 35.6 cm)

Replacement Parts

- JSTRN8** Strainer
- JCOV8** Cover
- JFAUC8** Faucet
- JTUBE8** Ice Tube
- JBOD5** Polycarbonate Body



WARNING: This product can expose you to chemicals including Bisphenol A (BPA), which is known to the State of California to cause birth defects or other reproductive harm. For more information, go to www.P65warnings.ca.gov. Warning applies to State of California only.

Juice Dispensers

Retro and sleek, these pieces come with polycarbonate bodies, faucets, covers, ice tubes and grated bases.

JUICE1 Dispenser, 8 ½ qt. (8 L)
14 ¼" L x 10 ¼" W x 22" H
(36.2 x 26 x 55.9 cm)

JUICE2 Dispensers, (2) 8 ½ qt. (8 L)
20" L x 10 ¼" W x 22" H
(50.8 x 26 x 55.9 cm)

Replacement Parts

- JSTRN6** Strainer
- JCOV1** Cover
- JTUBE5** Stainless Steel Ice Tube
- JFAUC4** Faucet
- JREP3** Polycarbonate Body



Allegro Coffee Urns

These 12 qt. (11.4 L) stainless steel urns feature a stylish faucet and a fuel holder. 11 ⅞" Dia. x 19 ¾" H (28.3 x 50.2 cm).

- ALLEGCU1** Gold Legs
- ALLEGCU2** Stainless Steel Legs

Allegro Coffee Urn Accessories

- AFAUC1** Faucet

Drip Trays

These stainless steel drip trays keep buffet space clean without sacrificing aesthetics.

DT3 5 ½" Dia. x ½" H (14 x 1.3 cm)

DT4 6" Sq. x ½" H (15.2 x 1.3 cm)



WARNING: This product can expose you to chemicals including Bisphenol A (BPA), which is known to the State of California to cause birth defects or other reproductive harm. For more information, go to www.P65warnings.ca.gov. Warning applies to State of California only.



Belaire™ Hollow Handle Buffetware

This collection features mirror-finished stainless steel, one-piece hollow handle construction and ergonomic finger grip design.

- SLL1** 1 oz., 11" L Spout Ladle (29.6 mL, 27.9 cm)
- SLL2** 2 oz., 12" L Spout Ladle (59.1 mL, 30.5 cm)
- SPT14** 14" L Perforated Turner (35.6 cm)
- SPS11** 11" L Pie Server (27.9 cm)
- SLP121** 12" L Slotted Spoon (30.5 cm)
- SSP120** 12" L Solid Spoon (30.5 cm)
- SLL6** 6 oz., 12" L Ladle (177.4 mL, 30.5 cm)
- SLL4** 4 oz., 12" L Ladle (118.3 mL, 30.5 cm)

Serving Tongs

- TGS6** 8 1/2" L x 2 1/2" W x 2 1/2" H (21.6 x 6.3 x 6.3 cm)
- TGS8** Perforated 8 1/2" L x 2 1/2" W x 2 1/2" H (21.6 x 6.3 x 6.3 cm)

Salad Scissor Tongs

- TONG3** Tong, Spoon/Spatula Design 10" L (25.4 cm)
- TONG2** Three-Tine Tong, Spoon/Fork Design 10" L (25.4 cm)

Evolution Stainless Steel Tongs

Designed with ergonomics and contemporary design in mind, these tongs come in a range of sizes for every use.

- TGS7** 7" L (17.8 cm)
- TGS8** 7 1/4" L (18.4 cm)
- TGS6** 6" L (15.2 cm)
- TGS9** 9 1/2" L (24.1 cm)
- TGS12** 12" L (30.5 cm)



Evolution Cheese Knives

Clean lines and satin stainless steel make these knives the most stylish way to serve all manner of cheeses.

CKNF6 Hard Cheese Knife
9" L (22.9 cm)

CKNF3 Fork-Tipped Hard Cheese Knife
9" L (22.9 cm)

CKNF5 Soft Cheese Knife
9" L (22.9 cm)

CKNF4 Hard Cheese Knife
5 ¼" L (13.3 cm)

CKNF7 Soft Cheese Spreader
6 ⅝" L (16.8 cm)

CKNF1 Flat Cheese Knife
5 ¼" L (13.3 cm)

CKNF2 Semi-Hard Cheese Knife
5 ¼" L (13.3 cm)



DIFFERENT STYLES FOR DIFFERENT VARIETIES OF CHEESE



Vintage Hammered Buffetware

Make a statement with our vintage finish buffetware. Elevate your next buffet service with these classically inspired accessories. Will patina with use.

Black

- BLHT6** 6" L Serving Tongs (15.2 cm)
- BLHT1** 9" L Serving Tongs (22.8 cm)
- BLHP10** 10" L Pie Server (25.4 cm)
- BLHF10** 10" L Cold Meat Fork (25.4 cm)
- BLHSS10** 10" L Slotted Spoon (25.4 cm)
- BLHSP10** 10" L Solid Spoon (25.4 cm)
- BLHML** 1 ½ oz., 11 ½" L Ladle (44.3 mL, 29.2 cm)
- BLHT2** 11 ¾" L Serving Tongs (29.8 cm)
- BLHSS** 11 ¾" L Slotted Spoon (29.8 cm)
- BLHSP** 13 ¾" L Solid Spoon (34.9 cm)

Bronze

- BVHT6** 6" L Serving Tongs (15.2 cm)
- BVHT1** 9" L Serving Tongs (22.8 cm)
- BVHP10** 10" L Pie Server (25.4 cm)
- BVHF10** 10" L Cold Meat Fork (25.4 cm)
- BVHSS10** 10" L Slotted Spoon (25.4 cm)
- BVHSP10** 10" L Solid Spoon (25.4 cm)
- BVHML** 1 ½ oz., 11 ½" L Ladle (44.3 mL, 29.2 cm)
- BVHT2** 11 ¾" L Serving Tongs (29.8 cm)
- BVHSS** 13 ¼" L Slotted Spoon (33.6 cm)
- BVHSP** 13 ¼" L Solid Spoon (33.6 cm)
- BVHL** 3 ½ oz., 13" L Ladle (103.5 mL, 33 cm)
- BVHP** 12 ¼" L Pie Server (31.1 cm)
- BVHF** 13" L Cold Meat Fork (33 cm)



DISHWASHER-SAFE
VIBRANT COLOR



Available in five classic finishes

Gold

- GVHT6** 6" L Serving Tongs (15.2 cm)
- GVHT1** 9" L Serving Tongs (22.8 cm)
- GVHP10** 10" L Pie Server (25.4 cm)
- GVHF10** 10" L Cold Meat Fork (25.4 cm)
- GVHSS10** 10" L Slotted Spoon (25.4 cm)
- GVHSP10** 10" L Solid Spoon (25.4 cm)
- GVHML** 1 ½ oz., 11 ½" L Ladle (44.3 mL, 29.2 cm)
- GVHT2** 11 ¾" L Serving Tongs (29.8 cm)
- GVHSS** 13 ¼" L Slotted Spoon (33.6 cm)
- GVHSP** 13 ¼" L Solid Spoon (33.6 cm)
- GVHL** 3 ½ oz., 13" L Ladle (103.5 mL, 33 cm)
- GVHP** 12 ¼" L Pie Server (31.1 cm)
- GVHF** 13" L Cold Meat Fork (33 cm)



Stainless Steel

- SVHT6** 6" L Serving Tongs (15.2 cm)
- SVHT1** 9" L Serving Tongs (22.8 cm)
- SVHP10** 10" L Pie Server (25.4 cm)
- SVHF10** 10" L Cold Meat Fork (25.4 cm)
- SVHSS10** 10" L Slotted Spoon (25.4 cm)
- SVHSP10** 10" L Solid Spoon (25.4 cm)
- SVHML** 1 ½ oz., 11 ½" L Ladle (44.3 mL, 29.2 cm)
- SVHT2** 11 ¾" L Serving Tongs (29.8 cm)
- SVHSS** 13 ¼" L Slotted Spoon (33.6 cm)
- SVHSP** 13 ¼" L Solid Spoon (33.6 cm)
- SVHL** 3 ½ oz., 13" L Ladle (103.5 mL, 33 cm)
- SVHP** 12 ¼" L Pie Server (31.1 cm)
- SVHF** 13" L Cold Meat Fork (33 cm)



Wavy Aged Stainless Steel Buffetware

- WVAT6** 6" L Serving Tongs (15.2 cm)
- WVAT1** 9" L Serving Tongs (22.8 cm)
- WVAP10** 10" L Pie Server (25.4 cm)
- WVAF10** 10" L Cold Meat Fork (25.4 cm)
- WVASS10** 10" L Slotted Spoon (25.4 cm)
- WVASP10** 10" L Solid Spoon (25.4 cm)
- WVAML** 1 ½ oz., 11 ½" L Ladle (44.3 mL, 29.2 cm)
- WVAT2** 11 ¾" L Serving Tongs (29.8 cm)
- WVASS** 13 ¼" L Slotted Spoon (33.6 cm)
- WVASP** 13 ¼" L Solid Spoon (33.6 cm)
- WVAL** 3 ½ oz., 13" L Ladle (103.5 mL, 33 cm)
- WVAP** 12 ¼" L Pie Server (31.1 cm)
- WVAF** 13" L Cold Meat Fork (33 cm)





HMMS18

HMMS14

HMMS13

HMMS12

HMMS10

IN 1/8, 1/4, 1/3, 1/2 AND 1 CUP



HM6TNG

HM8TNG

HM11CMF

HM11FK

HM12PIE

HM12PAS

HM14KN

Hammered Buffet Portioned Servers

With size-marked handles, these pieces are perfect wherever nutritional requirements need to be met.

HMMS18 1/8-Cup, 11 1/2" L Overall (29.6 mL, 29.2 cm)

HMMS14 1/4-Cup, 12" L Overall (59.1 mL, 30.5 cm)

HMMS13 1/3-Cup, 12 3/4" L Overall (78.8 mL, 32.4 cm)

HMMS12 1/2-Cup, 13" L Overall (118.3 mL, 33 cm)

HMMS10 1 Cup, 14" L Overall (236.6 mL, 35.6 cm)

Hammered Buffetware

Hammered stainless steel and inspired designs are time-honored ways of dressing up any buffet.

HM6TNG 6" L Serving Tongs (15.2 cm)

HM8TNG 8" L Serving Tongs (20.3 cm)

HM11CMF 11" L Cold Meat Fork (27.9 cm)

HM11FK 11" L Two-Tined Fork (27.9 cm)

HM12PIE 12" L Pie Server (30.5 cm)

HM12PAS 11" L Pastry Server (27.9 cm)

HM14KN 14" L Serrated Knife (35.6 cm)

HM1LAD 1 oz., 9" L Ladle (29.6 mL, 22.9 cm)

HM9SPN 9 1/2" L Spoon (24.1 cm)

HM12SL 12" L Slotted Spoon (30.5 cm)

HM12SOL 12" L Solid Spoon (30.5 cm)

HM12NOT 12" L Notched Spoon (30.5 cm)

HM10SPO 10" L Solid Spoon (25.4 cm)

HM10SL 10" L Slotted Spoon (25.4 cm)



HM1LAD

HM9SPN

HM12SL

HM12SOL

HM12NOT

HM10SPO

HM10SL



Mirage™ Buffetware

These stainless steel serving pieces come in an extensive collection for exceptional presentation consistency.

- SW12PAS** 11" L Pastry Server (27.9 cm)
- SW6TNG** 6" L Tongs (15.2 cm)
- SW9TNG** 9" L Tongs (22.9 cm)
- SW1LAD** 1 oz., 9" L Ladle (29.6 mL, 22.9 cm)
- SW9SPN** 9 ½" L Spoon (24.1 cm)
- SW10SPO** 10" L Solid Spoon (25.4 cm)
- SW12SOL** 12" L Solid Spoon (30.5 cm)
- SW12SL** 12" L Slotted Spoon (30.5 cm)
- SW12NOT** 12" L Notched Spoon (30.5 cm)
- ITS6** 6" L Ice Tongs (15.2 cm)
- PTS9** 8" L Serving Tongs (20.3 cm)
- PTC8** 8" L Pasta Tongs (20.3 cm)
- SW12PIE** 12" L Pie Server (30.5 cm)
- SW11CMF** 11" L Cold Meat Fork (27.9 cm)
- SW11FK** 11" L Two-Tine Fork (27.9 cm)
- SW14KN** 14" L Serrated Knife (35.6 cm)

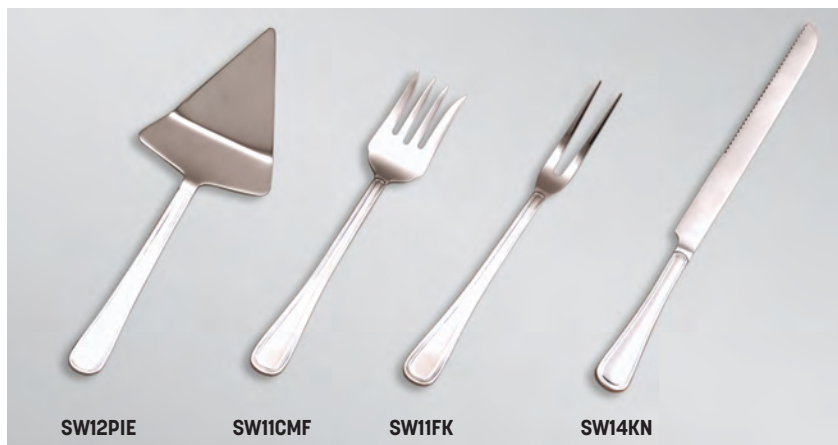



CER21

CER23

CER19



CER15



THE PRESTIGE™ CERAMIC COLLECTION

The unique shapes of these bowls and platters add fun and intrigue to anything you serve in them

Rectangular Ceramic Platters

- CER19** 14" L x 7 1/2" W x 2" H
(35.6 x 19.1 x 5.1 cm)
- CER23** 18 1/4" L x 9 1/4" W x 2 3/4" H
(46.4 x 23.5 x 7 cm)
- CER21** 21" L x 12 3/4" W x 3 1/4" H
(53.3 x 32.4 x 8.3 cm)

Square Ceramic Platter

- CER15** 14" Sq. x 1 1/2" H
(35.6 x 3.8 cm)

Wavy Ceramic Platters

- RTWVY1** 14 3/8" L x 8 3/4" W x 1 1/8" H
(36.5 x 22.2 x 2.9 cm)
- CER25** 21 3/4" L x 14 1/8" W x 2" H
(55.2 x 35.9 x 5.1 cm)

Squoval™ Ceramic Bowls

- SQVL712** 37 oz. (1.1 L)
12" L x 7" W x 2 3/4" H
(30.5 x 17.8 x 7 cm)
- SQVL914** 71 oz. (2.1 L)
14" L x 9" W x 3 1/4" H
(35.6 x 22.9 x 8.3 cm)



SQVL914



SQVL712

Shown with an AWRS riser set



Round Ceramic Bowls

- CER5** 40 oz. (1.2 L)
8 ½" Dia. x 3 ¼" H (21.6 x 8.3 cm)
- CER7** 60 oz. (1.8 L)
12" Dia. x 3 ¼" H (30.5 x 8.3 cm)
- CER9** 180 oz. (5.3 L)
17" Dia. x 5" H (43.2 x 12.7 cm)

Squound™ Ceramic Bowls and Sauce Cups

- SQSC15** 1 ½ oz. (44.4 mL)
2 ¾" Dia. x 1" H (7 x 2.5 cm)
- SQSC20** 2 oz. (59.1 mL)
3" Dia. x 1" H (7.6 x 2.5 cm)
- SQSC30** 3 oz. (88.7 mL)
3 ½" Dia. x 1 ¼" H (8.9 x 3.2 cm)
- SQSC40** 4 oz. (118.3 mL)
4" Dia. x 1 ½" H (10.2 x 3.8 cm)
- SQND7** 20 oz. (591.5 mL)
7" Dia. x 2 ⅞" H (17.8 x 7.3 cm)
- SQND9** 44 oz. (1.3 L)
9" Dia. x 3 ¼" H (22.9 x 8.3 cm)
- SQND11** 76 oz. (2.2 L)
10 ¾" Dia. x 4 ⅞" H (27.3 x 10.5 cm)
- SQND13** 122 oz. (3.6 L)
13" Dia. x 4 ½" H (33 x 11.4 cm)
- SQND15** 208 oz. (6.2 L)
15" Dia. x 5 ½" H (38.1 x 14 cm)





THE PRESTIGE™ PORCELAIN COLLECTION

The elegance of porcelain meets the playful profiles of our Prestige Collection, making this wide range of pieces extraordinarily versatile.

Square Porcelain Bowls and Sauce Cups

- CSC15** 1½ oz. (44.4 mL)
1" Sq. x 1½" H (2.5 x 2.9 cm)
- CSC20** 2 oz. (59.1 mL)
2½" Sq. x 1¾" H (6.4 x 3.5 cm)
- WFB3** 3 oz. (88.7 mL)
3" Sq. x 1⅝" H (7.6 x 4.1 cm)
- SQB55** 12 oz. (354.9 mL)
4⅞" Sq. x 2¾" H (12.4 x 7 cm)
- WFB6** 24 oz. (709.8 mL)
6" Sq. x 2⅝" H (15.2 x 6.7 cm)
- SQB88** 48 oz. (1.4 L)
8¼" Sq. x 2½" H (21 x 6.4 cm)
- WFB9** 85 oz. (2.5 L)
9" Sq. x 4" H (22.9 x 10.2 cm)
- WFB12** 193 oz. (5.7 L)
12" Sq. x 5" H (30.5 x 12.7 cm)

Shallow Porcelain Bowls

- POR9** Square, 72 oz. (2.1 L)
9¾" Sq. x 2¾" H
(24.8 x 7 cm)
- POR17** Rectangular, 144 oz. (4.3 L)
17¾" L x 9¾" W x 2¾" H
(45.1 x 24.8 x 7 cm)





Squavy™ Porcelain Bowls and Sauce Cups

- SQVY1** 1½ oz. (44.4 mL)
2¼" Dia. x 1½" H (5.7 x 3.8 cm)
- SQVY2** 2½ oz. (73.9 mL)
2½" Dia. x 1⅝" H (6.4 x 4.1 cm)
- SQVY3** 5 oz. (147.9 mL)
3½" Dia. x 1⅞" H (8.9 x 4.8 cm)
- SQVY4** 16 oz. (473.2 mL)
4½" Dia. x 2½" H (11.4 x 6.6 cm)
- SQVY5** 25 oz. (739.3 mL)
5½" Dia. x 3" H (14 x 7.6 cm)
- SQVY8** 87 oz. (2.6 L)
8½" Dia. x 3¾" H (21.6 x 9.5 cm)
- SQVY10** 162 oz. (4.8 L)
10½" Dia. x 4⅜" H (26.7 x 11.1 cm)
- SQVY12** 228 oz. (6.7 L)
12" Dia. x 5" H (30.5 x 12.7 cm)

Footed Porcelain Bowls

- PFB6** 24 oz. (709.8 mL)
6" Dia. x 3⅞" H (15.2 x 7.9 cm)
- PFB8** 60 oz. (1.8 L)
8" Dia. x 4¼" H (20.3 x 10.8 cm)
- PFB10** 124 oz. (3.7 L)
10" Dia. x 5⅞" H (25.4 x 13 cm)

POR1783



PORS140



FEATURES BUILT-IN SAUCE CUPS

PORS136



Three-Section Porcelain Platter

POR1783 17" L x 7 3/4" W x 1" H
(43.2 x 19.7 x 2.5 cm)

Porcelain Trays with Built-In Sauce Cups

PORS136 13" L x 6" W x 1/2" H
(33 x 15.2 x 1.3 cm)

PORS140 13" L x 9" W x 1/2" H
(33 x 22.9 x 1.3 cm)

Porcelain Impression Plate

CSP4 12 1/4" L x 11" W x 1" H
(31.1 x 27.9 x 2.5 cm)



CSP4

Rectangular Porcelain Platters

WLD11 11 1/2" L x 4" W x 7/8" H
(29.2 x 10.2 x 2.2 cm)

WLD13 13 1/2" L x 4 1/2" W x 1" H
(34.3 x 11.4 x 2.5 cm)

WLD15 15 1/2" L x 5" W x 1 1/8" H
(39.4 x 12.7 x 2.9 cm)



WLD15

WLD13

WLD11



PSPL12 shown with ACF125 card holder and TAGA8WT mini chalk card



Shown with BLCHD1, BLCHBC1 card holders, TAGA7WT mini chalk card and LFTD11 dome

Porcelain Serving Plates

PSPL8 8" Dia. x 1 1/4" H
(20.3 x 3.2 cm)

PSPL12 12" Dia. x 1 1/4" H
(30.5 x 3.2 cm)

Porcelain Serving Stands

Give pastries and baked goods a lift with these porcelain pedestal stands. Available in a variety of sizes and heights, each can be used together or on its own to provide added height to any dessert.

PSP4 4" Dia. x 3" H
(10.2 x 7.6 cm)

PSP8 8" Dia. x 3 1/8" H
(20.3 x 7.9 cm)

PSP12 12" Dia. x 5 1/4" H
(30.5 x 13.3 cm)

Black Matte Finish Porcelain Casseroles

The look of cast iron meets the durability and weight of porcelain. Smaller casseroles (20-24 oz.) are perfect for shared sides or warm desserts. Larger casseroles (64-104 oz.) work well at buffets.

PBB9 20 oz. (591.5 mL)
7 1/4" L x 4 1/4" W x 2" H
9 1/4" L with Handles
(18.4 x 10.8 x 5.1, 23.5 cm)

PBB09 24 oz. (709.8 mL)
8 1/8" L x 6" W x 2 1/2" H
9 1/4" L with Handles
(20.6 x 15.2 x 6.3, 23.5 cm)

PBB8 24 oz. (709.8 mL)
6 1/2" Sq. x 2" H
8 1/4" L with Handles
(16.5 x 5.1, 21 cm)

PBB13 64 oz. (1.9 L)
11 3/4" L x 10" W x 2" H
13 1/2" L with Handles
(29.8 x 25.4 x 5.1, 34.3 cm)

PBB135 104 oz. (3.1 L)
10 1/2" L x 9 1/4" W x 3" H
13 1/8" L with Handles
(26.7 x 23.5 x 7.6, 33.3 cm)

PBB12 92 oz. (2.7 L)
12 1/4" L x 9 3/4" W x 2 1/2" H
(31.1 x 24.8 x 6.4 cm)





THE TRANSCUENCE COLLECTION

We don't say "breathtaking" lightly, but this collection demands it. These hand-crafted resin serving vessels feature a rich marbled design. Food-safe and stain-resistant, they combine elegance with durability.

Round Transcendence Bowls and Platter

WSBM11 Bowl, 84 ½ oz. (2.5 L)
11 ½" Dia. x 3 ½" H
(29.2 x 8.9 cm)

WSP15 Platter, 74 ½ oz. (2.2 L)
15 ¼" Dia. x 2 ⅞" H
(38.7 x 5.4 cm)

WSBL15 Bowl, 169 oz. (5 L)
15 ¾" Dia. x 3 ½" H
(40 x 8.9 cm)

Oblong Transcendence Bowls

WSMB17 Bowl, 47 ½ oz. (1.4 L)
17 ¾" L x 4 ¾" W x 2 ⅜" H
(45.1 x 12.1 x 6 cm)

WSLB27 Bowl, 169 oz. (5 L)
27 ¼" L x 7 ½" W x 3 ⅜" H
(69.2 x 19.1 x 8.6 cm)

Rectangular Transcendence Platter

WSRT21 21 ⅞" L x 9 ¾" W x 1 ⅞" H
(53.7 x 24.8 x 4.1 cm)





THE GLACIER™ GLASS COLLECTION

When it comes to our Glacier Collection, the beauty is in the details. These platters and bowls make every meal a social-media-worthy moment.

Rectangular Green Glacier Platters

- BG159** 15" L x 9" W x 7/8" H
(38.1 x 22.9 x 2.2 cm)
- BG189** 18" L x 9" W x 7/8" H
(45.7 x 22.9 x 2.2 cm)
- BG1911** 19" L x 11" W x 7/8" H
(48.3 x 27.9 x 2.2 cm)
- BG2113** 21" L x 13" W x 7/8" H
(53.3 x 33 x 2.2 cm)

Round Glacier Bowls

Recycled Green Glass

- GBG14** 98 oz. (2.9 L)
14" Dia. x 3" H (35.6 x 7.6 cm)
- GBG19** 128 oz. (3.8 L)
18" Dia. x 3 1/2" H (45.7 x 8.9 cm)

Blue Glass

- GBB15** 98 oz. (2.9 L)
14" Dia. x 3" H (35.6 x 7.6 cm)
- GBB20** 128 oz. (3.8 L)
18" Dia. x 3 1/2" H (45.7 x 8.9 cm)





THE ORGANIC EDGES ON THESE RIMS ENHANCE THE NATURAL LOOK OF THESE PIECES



THE RAIN COLLECTION

From organic edges to natural rain-splashed designs, every detail of these plastic platters and bowls is crafted with intent. And because it's lightweight to boot, the Rain Collection is as practical as it is beautiful.

Square Rain Bowls

- CRGSQ53** 23 oz. (680.2 mL)
5" Sq. x 2 7/8" H (12.7 x 7.3 cm)
- CRGSQ73** 58 oz. (1.7 L)
7" Sq. x 3 1/4" H (17.8 x 8.3 cm)
- CRGSQ94** 125 oz. (3.7 L)
9 1/2" Sq. x 4" H (24.1 x 10.2 cm)
- CRGSQ117** 228 oz. (6.7 L)
12" Sq. x 4 1/2" H (30.5 x 11.4 cm)

Rectangular Rain Platters

- CRGT19** 48 oz. (1.4 L)
14" L x 7 1/2" W x 1 1/2" H
(35.6 x 19.1 x 3.8 cm)
- CRGT23** 92 oz. (2.7 L)
18" L x 9" W x 2" H
(45.7 x 22.9 x 5.1 cm)
- CRGT21** 152 oz. (4.5 L)
21" L x 13" W x 2" H
(53.3 x 33 x 5.1 cm)



**THE ENDURANCE™
MELAMINE COLLECTION**

If you need a collection that can stand the rigors of everyday performance, you're in the right place. These bowls, platters and plates are manufactured from highly durable melamine for long-lasting reliability. Not recommended for microwave use.

Shallow Melamine Bowls

- MELRC3** 10 oz. (295.7 mL)
5 5/8" L x 3 3/8" W x 1 3/4" H
(14.3 x 8.6 x 4.4 cm)
- MELSQ6** 16 oz. (473.2 mL)
6" Sq. x 2" H (15.2 x 5.1 cm)
- MELSQ8** 36 oz. (1.1 L)
8" Sq. x 2" H (20.3 x 5.1 cm)
- MELSQ10** 64 oz. (1.9 L)
10" Sq. x 2" H (25.4 x 5.1 cm)

Square Rimmed Melamine Bowls

- MEL40** 66 oz. (2 L)
9 3/4" Sq. x 3" H (24.8 x 7.6 cm)
- MEL41** 202 oz. (6 L)
14 3/4" Sq. x 3" H (37.5 x 7.6 cm)





Rectangular Melamine Bowls HOT

- MLRP9** 48 oz. (1.4 L)
9 3/4" L x 5 7/8" W x 2 3/4" H
(24.8 x 14.9 x 7 cm)
- MLRP13** 136 oz. (4 L)
13 3/4" L x 9 7/8" W x 2 3/4" H
(34.9 x 24.8 x 7 cm)
- MLRP17** 233 oz. (6.9 L)
17 5/8" L x 11 7/8" W x 2 3/4" H
(44.8 x 31.2 x 7 cm)
- MLRP19** 157 oz. (4.6 L)
19 5/8" L x 8" W x 3" H
(49.8 x 20.3 x 7.6 cm)

Square Melamine Bowls HOT

- MELSQ53** 23 oz. (680.2 mL)
5" Sq. x 2 7/8" H (12.7 x 7.3 cm)
- MELSQ73** 58 oz. (1.7 L)
7" Sq. x 3 1/4" H (17.8 x 8.3 cm)
- MELSQ94** 125 oz. (3.7 L)
9 1/2" Sq. x 4" H (24.1 x 10.2 cm)
- MELSQ117** 208 oz. (6.2 L)
12" Sq. x 4 1/2" H (30.5 x 11.4 cm)

Disposable Liners

- PBSL53** 23 oz. (680.2 mL)
2 7/8" H (7.3 cm) PET Liner
for 5" Sq. (12.7 cm) Bowls
- PBSL73** 58 oz. (1.7 L)
3 1/4" H (8.3 cm) PET Liner
for 7" Sq. (17.8 cm) Bowls
- PBSL94** 125 oz. (3.7 L)
4" H (10.2 cm) PET Liner
for 9 1/2" Sq. (24.1 cm) Bowls
- PBSL124** 228 oz. (6.7 L)
4 1/2" H (11.4 cm) PET Liner
for 12" Sq. (30.5 cm) Bowls

Three-Compartment Melamine Serving Bowls

Made from durable melamine, these triple-compartment bowls are ideal for appetizer platters and other good things that come in threes.

- MSQ3** 14 oz. (414 mL) Each Compartment
14 ¾" L x 5 ⅞" W x 1 ¾" H
(37.5 x 15 x 4.4 cm)
- MRD3** 12 oz. (354.9 mL) Each Compartment
14 ⅝" L x 5" W x 2 ¼" H
(37.1 x 12.7 x 5.7 cm)



Angled Round Melamine Bowls

- MELSL52** 11 oz. (325.3 mL)
5" Dia. x 3 ¼" H (12.7 x 8.3 cm)
- MELSL82** 40 oz. (1.2 L)
8" Dia. x 5" H (20.3 x 12.7 cm)
- MELSL92** 64 oz. (1.9 L)
9 ¼" Dia. x 5 ¼" H (23.5 x 13.3 cm)
- MELSL112** 112 oz. (3.3 L)
12" Dia. x 6 ½" H (30.5 x 16.5 cm)



Shallow Round Melamine Bowls

Whether you serve poke bowls, açai bowls or regular old mac & cheese, these beautiful white pieces will present your creations with style.

- MELR5** 8 oz. (236.6 mL)
5 ¼" Dia. x 1" H (13.3 x 2.5 cm)
- MELR6** 14 oz. (414 mL)
6 ⅝" Dia. x 1 ⅜" H (16.8 x 3.5 cm)
- MELR8** 28 oz. (828 mL)
8" Dia. x 1 ¾" H (20.3 x 4.4 cm)
- MELR9** 46 oz. (1.4 L)
9 ½" Dia. x 2 ⅞" H (24.1 x 5.4 cm)
- MELR11** 86 oz. (2.5 L)
11 ¼" Dia. x 2 ⅞" H (28.6 x 6 cm)





MLRS12 shown
inside MLRS21

MLRS9

MLRS16

Oblong Melamine Bowls

These memorable oval-shaped bowls are perfectly sized for a variety of food presentations. Ideal for buffets and table service alike.

MLRS9 18 oz. (532.3 mL)
9" L x 6" W x 1 3/4" H
(22.9 x 15.2 x 4.4 cm)

MLRS12 42 oz. (1.2 L)
12" L x 9" W x 2" H
(30.5 x 22.9 x 5.1 cm)

MLRS16 64 oz. (1.9 L)
16 7/8" L x 8 1/4" W x 2 3/8" H
(42.9 x 21 x 6 cm)

MLRS21 194 oz. (5.7 L)
21" L x 14" W x 2 7/8" H
(53.3 x 35.6 x 7.3 cm)

Flared Round Melamine Bowls

FLRB8 33 oz. (1 L)
8" Dia. x 3 3/4" H (20.3 x 9.5 cm)

FLRB95 54 oz. (1.6 L)
9 1/2" Dia. x 4" H (24.1 x 10.2 cm)

FLRB11 80 oz. (2.4 L)
11" Dia. x 4 3/4" H (27.9 x 12.1 cm)

Round Melamine Bowls

MEL5 57 oz. (1.7 L)
8 1/2" Dia. x 3 3/8" H (21.6 x 8.6 cm)

MEL7 87 oz. (2.6 L)
12" Dia. x 3 3/4" H (30.5 x 9.5 cm)

MEL9 270 oz. (8 L)
17" Dia. x 4 7/8" H (43.2 x 12.4 cm)



FLRB95

FLRB8

FLRB11



MEL9



MEL7



MEL5

FITS THE TTRS3
STAND PG. 256

MEGA Melamine Bowl

MEL22 25 qt. (23.7 L)
24" Dia. x 6" H (61 x 15.2 cm)

Crave Melamine Serveware NSF BPA FREE

Round Bowls

CBL78CL Cloud
78 oz. (2.3 L)
9 1/2" Dia. x 3 5/8" H (24.1 x 9.2 cm)

CBL78SH Shadow
78 oz. (2.3 L)
9 1/2" Dia. x 3 5/8" H (24.1 x 9.2 cm)

CBL185CL Cloud
185 oz. (5.5 L)
13" Dia. x 4 1/2" H (33 x 11.4 cm)

CBL185SH Shadow
185 oz. (5.5 L)
13" Dia. x 4 1/2" H (33 x 11.4 cm)

CBL325CL Cloud
10 qt. (9.4 L)
16" Dia. x 5 1/4" H (40.6 x 13.3 cm)

CBL325SH Shadow
10 qt. (9.4 L)
16" Dia. x 5 1/4" H (40.6 x 13.3 cm)

Rectangular Platters

CPL14CL Cloud
14 1/4" L x 7 3/8" W x 1 3/8" H
(36.2 x 18.7 x 3.5 cm)

CPL14SH Shadow
14 1/4" L x 7 3/8" W x 1 3/8" H
(36.2 x 18.7 x 3.5 cm)

CPL21CL Cloud
21" L x 12 7/8" W x 2" H
(53.3 x 32.7 x 5.1 cm)

CPL21SH Shadow
21" L x 12 7/8" W x 2" H
(53.3 x 32.7 x 5.1 cm)



MEL22



CBL185

CBL78

CBL325



CPL14CL

CPL14SH

CPL21SH

CPL21CL



FROM SMALLEST
TO LARGEST:
MTP14, MTP16, MTP18

NEW

Melamine Serving Plates ^{NEW}

Serve up your favorite pie on these versatile, durable and washable melamine serving plates. A sleek way to plate up any slice!

- MTP10** 10" Dia. x ¾" H (25.4 x 1.9 cm)
- MTP12** 12" Dia. x 1 ⅛" H (30.5 x 2.9 cm)
- MTP14** 14" Dia. x 1 ⅛" H (35.6 x 2.9 cm)
- MTP16** 16" Dia. x 1 ⅛" H (40.6 x 2.9 cm)
- MTP18** 18" Dia. x 1 ⅛" H (45.7 x 2.9 cm)

Square Melamine Platters

- SQP10** 12" Sq. x 1 ⅜" H (30.5 x 3.5 cm)
- SQP12** 14" Sq. x 1 ½" H (35.6 x 3.8 cm)
- SQP16** 16" Sq. x 2" H (40.6 x 5.1 cm)

Flat Melamine Platters

- MEL148** 14 ½" L x 8 ¾" W x ¾" H (36.8 x 21 x 1.9 cm)
- MEL189** 18 ¼" L x 9" W x ¾" H (46.4 x 22.9 x 1.9 cm)
- MEL1414** 14 ⅜" Sq. x ¾" H (36.5 x 1.9 cm)
- MEL2113** 21 ½" L x 13" W x ¾" H (54.6 x 33 x 1.9 cm)



SQP10

SQP12

SQP16



MEL148

MEL189

MEL2113

MEL1414



Rectangular Melamine Platters HOT

- MEL12** 12" L x 7" W x 1 1/4" H
(30.5 x 17.8 x 3.2 cm)
- MEL19** 14 1/4" L x 7 1/2" W x 1 1/2" H
(36.2 x 19.1 x 3.8 cm)
- MEL23** 18" L x 8 1/4" W x 2" H
(45.7 x 21 x 5.1 cm)
- MEL21** 21" L x 13" W x 2" H
(53.3 x 33 x 5.1 cm)

Disposable Liners

- PBSL1** PET Liner for MEL19
13 3/4" L x 7 1/4" W x 1" H
(34.9 x 18.4 x 2.5 cm)
- PBSL2** PET Liner for MEL23
17 1/2" L x 8 3/4" W x 2" H
(44.5 x 22.2 x 5.1 cm)
- PBSL3** PET Liner for MEL21
19 1/2" L x 12" W x 2" H
(49.5 x 30.5 x 5.1 cm)

Concave Melamine Platters

- MEL44** Triangular, 17" L x 2 1/4" H
(43.2 x 5.7 cm)
- MEL42** Square, 12" Sq. x 1 5/8" H
(30.5 x 4.1 cm)
- MEL43** Square, 16" Sq. x 2" H
(40.6 x 5.1 cm)

Boat Melamine Platters

- MEL49** 24" L x 9" W x 1 5/8" H
(61 x 22.9 x 4.1 cm)
- MEL50** 28" L x 11 1/4" W x 1 1/2" H
(71.1 x 28.6 x 3.8 cm)



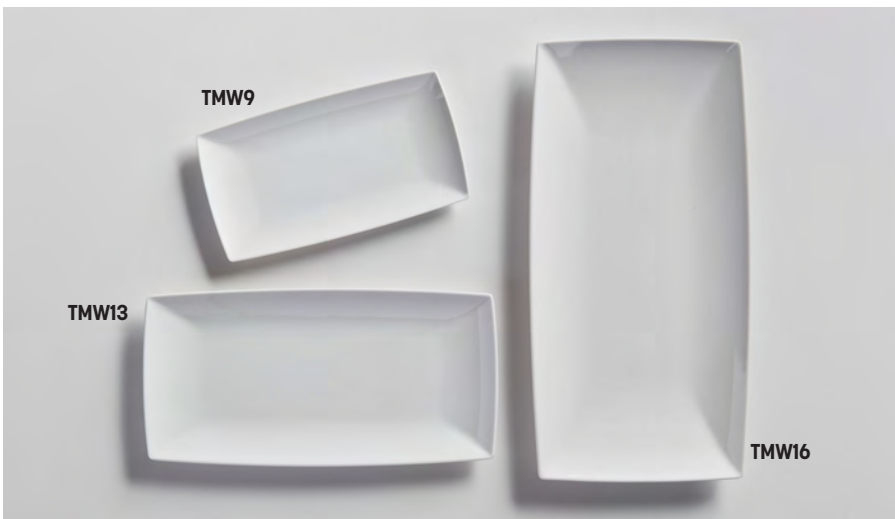

WORKS PERFECTLY IN
HIGH-END SETTINGS

Rectangular Melamine Serving Trays

Simple and versatile, these white melamine trays are as dapper as they are durable.

TMW9 9 3/8" L x 5 1/8" W x 3/4" H
(23.8 x 13 x 1.9 cm)

TMW13 13 7/8" L x 6 1/2" W x 7/8" H
(35.2 x 16.5 x 2.2 cm)

TMW16 16" L x 8" W x 1 1/8" H
(40.6 x 20.3 x 2.9 cm)



FROM TOP
TO BOTTOM:
AWME19
AWME23
AWME21

DETAILED WITH ORGANIC EDGES,
TEXTURED SURFACES AND MOTTLED ACCENTS

Rectangular Antique White Melamine Platters

AWME19 14 1/4" L x 7 1/2" W x 1 1/2" H
(36.2 x 19.1 x 3.8 cm)

AWME23 18" L x 8 1/4" W x 2" H
(45.7 x 21 x 5.1 cm)

AWME21 21" L x 13" W x 2" H
(53.3 x 33 x 5.1 cm)



PORCELAIN LOOKS, MELAMINE DURABILITY

Square Antique White Melamine Bowls

AWMSQ53 23 oz. (680.2 mL)
5" Sq. x 2 7/8" H (12.7 x 7.3 cm)

AWMSQ73 58 oz. (1.7 L)
7" Sq. x 3 1/4" H (17.8 x 8.3 cm)

AWMSQ94 125 oz. (3.7 L)
9 1/2" Sq. x 4" H (24.1 x 10.2 cm)

AWMSQ117 216 oz. (6.4 L)
12" Sq. x 4 1/2" H (30.5 x 11.4 cm)

Trapezoid Melamine Platters

- TRPZ12** 12 1/2" L x 8 1/4" W x 1 1/2" H
(31.8 x 21 x 3.8 cm)
- TRPZ18** 18 3/8" L x 8 1/8" W x 1 1/2" H
(46.7 x 20.6 x 3.8 cm)
- TRPZ23** 22 7/8" L x 8 1/4" W x 1 1/2" H
(58.1 x 21 x 3.8 cm)

Rimmed Rectangular Melamine Platters HOT

Black Rimmed/White Platters

- MRSW6** 6 7/8" L x 4 1/4" W x 1 1/8" H
(17.5 x 10.8 x 2.9 cm)
- MRSW13** 12 3/4" L x 7" W x 1 1/8" H
(32.4 x 17.8 x 2.9 cm)
- MRSW9** 9 7/8" Sq. x 1 1/8" H
(25.1 x 2.9 cm)
- MRSW12** 12 7/8" L x 10 1/4" W x 1 1/8" H
(32.7 x 26 x 2.9 cm)

Blue Speckled/White Platters

- MRSS6** 6 7/8" L x 4 1/4" W x 1 1/8" H
(17.5 x 10.8 x 2.9 cm)
- MRSS13** 12 3/4" L x 7" W x 1 1/8" H
(32.4 x 17.8 x 2.9 cm)
- MRSS9** 9 7/8" Sq. x 1 1/8" H
(25.1 x 2.9 cm)
- MRSS12** 12 7/8" L x 10 1/4" W x 1 1/8" H
(32.7 x 26 x 2.9 cm)



Shown with MJ17 mason jar, 3307 shaker, 3306 shaker and NSB4 number stand



Shown with PMSS62 S&P set and MB3 sauce cup



Rimmed Rectangular Melamine Bowls

Black Rimmed/White Bowls

MRCW6	26 oz. (768.9 mL) 6 7/8" L x 4 1/8" W x 3 1/4" H (17.5 x 10.5 x 7.9 cm)
MRCW7	44 oz. (1.3 L) 6 3/8" L x 6 7/8" W x 3 1/4" H (16.2 x 17.5 x 7.9 cm)
MRCW10	64 oz. (1.8 L) 10 3/8" L x 6 3/8" W x 3 1/4" H (26.4 x 16.2 x 8.3 cm)
MRCW13	82 oz. (2.4 L) 12 5/8" L x 6 3/4" W x 3 1/4" H (32.1 x 17.1 x 8.3 cm)
MRCW9	98 oz. (2.8 L) 9 3/4" Sq. x 3 1/4" H (24.8 x 8.3 cm)
MRW615	106 oz. (3.1 L) 15" L x 6" W x 3 1/4" H (15.2 x 38.1 x 7.9 cm)
MRCW12	131 oz. (3.8 L) 11 3/4" L x 10 3/8" W x 3 1/4" H (29.8 x 26.4 x 8.3 cm)
MRW815	144 oz. (4.3 L) 15" L x 8" W x 3 1/4" H (20.3 x 38.1 x 7.9 cm)
MRW1215	212 oz. (6.3 L) 15" L x 12" W x 3 1/4" H (30.5 x 38.1 x 7.9 cm)

Blue Speckled/White Bowls

MRCS6	26 oz. (768.9 mL) 6 7/8" L x 4 1/8" W x 3 1/4" H (17.5 x 10.5 x 7.9 cm)
MRCS7	44 oz. (1.3 L) 6 3/8" L x 6 7/8" W x 3 1/4" H (16.2 x 17.5 x 7.9 cm)
MRCS10	64 oz. (1.8 L) 10 3/8" L x 6 3/8" W x 3 1/4" H (26.4 x 16.2 x 8.3 cm)
MRCS13	82 oz. (2.4 L) 12 5/8" L x 6 3/4" W x 3 1/4" H (32.1 x 17.1 x 8.3 cm)
MRCS9	98 oz. (2.8 L) 9 3/4" Sq. x 3 1/4" H (24.8 x 8.3 cm)
MRS615	106 oz. (3.1 L) 15" L x 6" W x 3 1/4" H (15.2 x 38.1 x 7.9 cm)
MRCS12	131 oz. (3.8 L) 11 3/4" L x 10 3/8" W x 3 1/4" H (29.8 x 26.4 x 8.3 cm)
MRS815	144 oz. (4.3 L) 15" L x 8" W x 3 1/4" H (20.3 x 38.1 x 7.9 cm)
MRS1215	212 oz. (6.3 L) 15" L x 12" W x 3 1/4" H (30.5 x 38.1 x 7.9 cm)

Shown with PSP8 and PSP4 serving stands and GVHT1 tongs

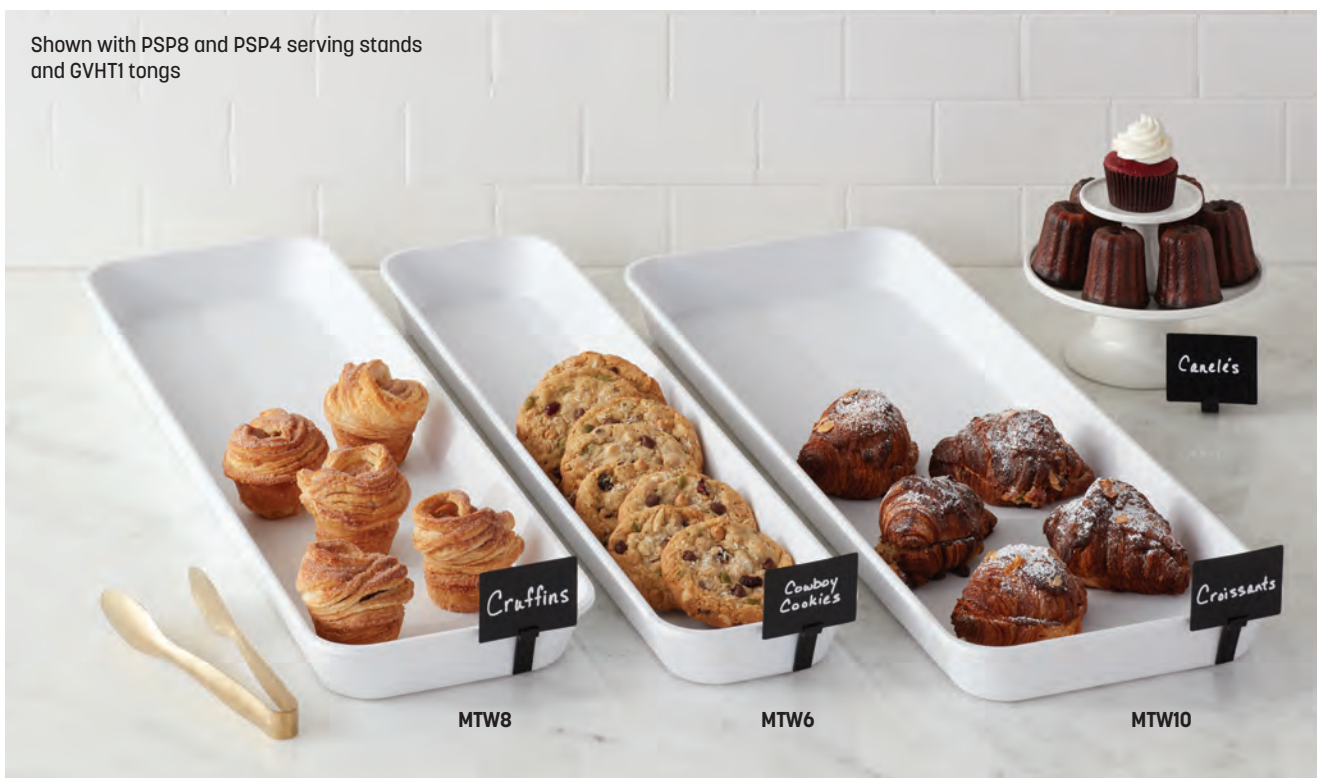

Rectangular Market Trays

The perfect solution for deli cases everywhere, these large melamine trays beautifully display all types of food.

White

- MTW6** 150 oz. (4.4 L)
29 3/4" L x 6 1/8" W x 2" H
(75.5 x 15.5 x 5 cm)
- MTW8** 216 oz. (6.3 L)
29 3/4" L x 8 1/2" W x 2" H
(75.5 x 21.5 x 5 cm)
- MTW10** 270 oz. (7.9 L)
29 3/4" L x 10 1/2" W x 2" H
(75.5 x 26.6 x 5 cm)

Black

- MT6** 150 oz. (4.4 L)
29 3/4" L x 6 1/8" W x 2" H
(75.5 x 15.5 x 5 cm)
- MT8** 216 oz. (6.3 L)
29 3/4" L x 8 1/2" W x 2" H
(75.5 x 21.5 x 5 cm)
- MT10** 270 oz. (7.9 L)
29 3/4" L x 10 1/2" W x 2" H
(75.5 x 26.6 x 5 cm)





THE LIFT COLLECTION

The Lift Collection elevates your culinary creations in more ways than one. This family of bowls, plates, pedestals and domes is fully interchangeable and buildable, so the only limit to your presentation potential is your own creativity.

Lift Collection Bowls

White

- LFTBW8** 40 oz. (1.2 L)
8 1/2" Dia. x 3 1/2" H (21.6 x 8.9 cm)
- LFTBW9** 68 oz. (2 L)
9 7/8" Dia. x 4 1/2" H (25.1 x 11.4 cm)
- LFTBW11** 110 oz. (3.3 L)
11 1/4" Dia. x 5 1/2" H (28.6 x 14 cm)

Black Speckled

- LFTBB8** 40 oz. (1.2 L)
8 1/2" Dia. x 3 1/2" H (21.6 x 8.9 cm)
- LFTBB9** 68 oz. (2 L)
9 7/8" Dia. x 4 1/2" H (25.1 x 11.4 cm)
- LFTBB11** 110 oz. (3.3 L)
11 1/4" Dia. x 5 1/2" H (28.6 x 14 cm)

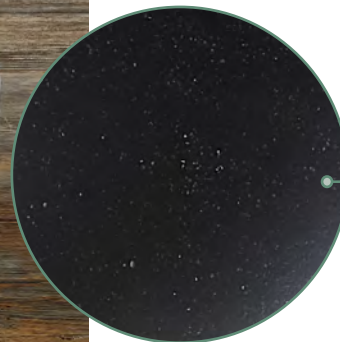

FEATURES A TRENDY,
SPECKLED DESIGN

Lift Collection Plates

White

LFTPW11 8 7/8" Dia. x 1" H (22.5 x 2.5 cm)

LFTPW12 11 3/4" Dia. x 1" H (29.8 x 2.5 cm)

LFTPW13 13" Dia. x 1" H (33 x 2.5 cm)

Black Speckled

LFTPBI1 8 7/8" Dia. x 1" H (22.5 x 2.5 cm)

LFTPBI2 11 3/4" Dia. x 1" H (29.8 x 2.5 cm)

LFTPBI3 13" Dia. x 1" H (33 x 2.5 cm)

Lift Collection Pedestals

White

LFTW63 6 1/2" Dia. x 3 1/4" H (16.5 x 8.3 cm)

LFTW65 6 1/2" Dia. x 4 7/8" H (16.5 x 12.4 cm)

LFTW67 6 1/2" Dia. x 7 1/8" H (16.5 x 18.1 cm)

Black

LFTB63 6 1/2" Dia. x 3 1/4" H (16.5 x 8.3 cm)

LFTB65 6 1/2" Dia. x 4 7/8" H (16.5 x 12.4 cm)

LFTB67 6 1/2" Dia. x 7 1/8" H (16.5 x 18.1 cm)

Lift Collection Domes

LFTD8 8 1/8" Dia. x 6 5/8" H (20.6 x 16.8 cm)

LFTD11 11" Dia. x 8 5/8" H (27.9 x 21.9 cm)

LFTD12 12 1/8" Dia. x 9 1/8" H (30.8 x 23.2 cm)



WARNING: This product can expose you to chemicals including Bisphenol A (BPA), which is known to the State of California to cause birth defects or other reproductive harm. For more information, go to www.P65warnings.ca.gov. Warning applies to State of California only.

Shown with BCH125 card holders
and TAGA7BL chalk cards

NEW

LFTBW12 shown with
LFTB67 pedestal



LFTBW16



LFTBB12 shown with
LFTW67 pedestal

NEW

LFTBB16

Lift Collection Large Bowls NEW

Larger functions require larger capacities. Available in both 94 and 104 ounces, these generously-sized angled bowls are ideal for feeding the crowd. Give each bowl a "lift" with one of the collection's threaded pedestals (sold separately) and you are ready for the masses.

White

LFTBW12 94 oz. (2.8 L)
12" Dia. x 4" H (30.5 x 10.2 cm)

LFTBW16 104 oz. (3.1 L)
16" Dia. x 3" H (40.6 x 7.6 cm)

Black Speckled

LFTBB12 94 oz. (2.8 L)
12" Dia. x 4" H (30.5 x 10.2 cm)

LFTBB16 104 oz. (3.1 L)
16" Dia. x 3" H (40.6 x 7.6 cm)

Shown with BAMBL125, BAMBL4 card holders, TAGA7WT chalk cards, GGRW3 bowls, SLR3 lids and DTSL1 safety labels

NEW

LFTPB24 shown with LFTW65 pedestal



LFTPB22

Lift Collection Platters NEW

Our Lift Collection plates now have big brothers. Amply sized to feed large groups, each platter offers the flexibility to be used with or without a pedestal (sold separately). Mix with the other plates and bowls in the line for a truly flexible and versatile presentation.

Black Speckled

LFTPB22 22" L x 12 1/4" W x 2 1/4" H
(55.9 x 31.1 x 5.7 cm)

LFTPB24 24" L x 9 1/2" W x 2 3/4" H
(61 x 24.1 x 7 cm)

White

LFTPW22 22" L x 12 1/4" W x 2 1/4" H
(55.9 x 31.1 x 5.7 cm)

LFTPW24 24" L x 9 1/2" W x 2 3/4" H
(61 x 24.1 x 7 cm)

NEW

LFTPW24 shown with LFTB63 pedestal



LFTPW24



THE GRAB & GO COLLECTION

Pack it, stack it and grab it! This reusable collection was curated with reinvention of buffet and group dining in mind. Made of dishwasher-safe melamine and coordinating SAN lids, these bowls keep food safe from germs and contaminants.

Round Bowls

White

- GGRW3** 4 oz. (118.3 mL)
3 3/8" Dia. x 1 3/8" H (8.6 x 3.5 cm)
- GGRW5** 9 1/2 oz. (280.9 mL)
4 7/8" Dia. x 1 7/8" H (12.4 x 4.8 cm)
- GGRW6** 18 oz. (532.3 mL)
6" Dia. x 2 3/8" H (15.2 x 6 cm)
- GGRW8** 32 oz. (946.4 mL)
8 1/2" Dia. x 2" H (21.6 x 5.1 cm)

Black Speckled

- GGRB3** 4 oz. (118.3 mL)
3 3/8" Dia. x 1 3/8" H (8.6 x 3.5 cm)
- GGRB5** 9 1/2 oz. (280.9 mL)
4 7/8" Dia. x 1 7/8" H (12.4 x 4.8 cm)
- GGRB6** 18 oz. (532.3 mL)
6" Dia. x 2 3/8" H (15.2 x 6 cm)
- GGRB8** 32 oz. (946.4 mL)
8 1/2" Dia. x 2" H (21.6 x 5.1 cm)

Round Lids

- SLR3** Lid, Fits GGRW3 and GGRB3
3 1/2" Dia. x 1" H (8.9 x 2.5 cm)
- SLR5** Lid, Fits GGRW5 and GGRB5
5 1/8" Dia. x 1" H (13 x 2.5 cm)
- SLR6** Lid, Fits GGRW6 and GGRB6
6 1/8" Dia. x 1" H (15.6 x 2.5 cm)
- SLR8** Lid, Fits GGRW8 and GGRB8
8 1/2" Dia. x 1" H (21.6 x 2.5 cm)
(not shown)



Square Bowls

White

- GGSW5** 12 ½ oz. (369.7 mL)
5" Sq. x 1 ⅝" H (12.7 x 4.1 cm)
- GGSW6** 27 oz. (798.5 mL)
6 ½" Sq. x 2 ⅞" H (16.5 x 5.4 cm)

Black Speckled

- GGSB5** 12 ½ oz. (369.7 mL)
5" Sq. x 1 ⅝" H (12.7 x 4.1 cm)
- GGSB6** 27 oz. (798.5 mL)
6 ½" Sq. x 2 ⅞" H (16.5 x 5.4 cm)

Square Lids

- SLS5** Lid, Fits GGSW5 and GGSB5
5" Sq. x 1" H (12.7 x 2.5 cm)
- SLS6** Lid, Fits GGSW6 and GGSB6
6 ⅝" Sq. x 1" H (16.8 x 2.5 cm)

Rectangular Bowls

White

- GGW74** 17 oz. (502.8 mL)
7" L x 4 ¼" W x 2 ⅞" H
(17.8 x 10.8 x 5.4 cm)
- GGW76** 46 oz. (1.4 L)
7" L x 6 ⅜" W x 3" H
(17.8 x 16.2 x 7.6 cm)
- GGW96** 25 ½ oz. (754.1 mL)
9" L x 6" W x 2" H
(22.9 x 15.2 x 5.1 cm)

Black Speckled

- GGB74** 17 oz. (502.8 mL)
7" L x 4 ¼" W x 2 ⅞" H
(17.8 x 10.8 x 5.4 cm)
- GGB76** 46 oz. (1.4 L)
7" L x 6 ⅜" W x 3" H
(17.8 x 16.2 x 7.6 cm)
- GGB96** 25 ½ oz. (754.1 mL)
9" L x 6" W x 2" H
(22.9 x 15.2 x 5.1 cm)

Rectangular Lids

- SL74** Lid, Fits GGW74 and GGB74
7 ⅞" L x 4 ⅜" W x 1" H
(18.1 x 11.1 x 2.5 cm)
- SL76** Lid, Fits GGW76 and GGB76
7" L x 6 ½" W x 1" H
(17.8 x 16.5 x 2.5 cm)
- SL96** Lid, Fits GGW96 and GGB96
9" L x 6" W x 1" H
(22.9 x 15.2 x 2.5 cm)
(not shown)





MTB20

MTW20

Shown with NSB10 number stand,
MSCSW3 sauce cup and MCB36WH bowl



MTW14

MTB14

Black and White Melamine Serving Trays

You can't go wrong with a timeless black and white color scheme. Perfect for food halls, marketplaces and quick serve restaurants, these lightweight, dishwasher-safe trays are the perfect carrying case for your meal.

Large

MTB20 Black
19 3/8" L x 12 1/2" W x 1" H
(49.2 x 31.8 x 2.5 cm)

MTW20 White
19 3/8" L x 12 1/2" W x 1" H
(49.2 x 31.8 x 2.5 cm)

Small

MTB14 Black
14" L x 10" W x 1" H
(35.6 x 25.4 x 2.5 cm)

MTW14 White
14" L x 10" W x 1" H
(35.6 x 25.4 x 2.5 cm)

Non-Slip Wood Melamine Serving Trays

These trays are a cocktail server's best friend. With a skid-resistant silicone layer, they make bar-to-table transport a breeze.

Round

MNSTR12 12" Dia. x 5/8" H
(30.5 x 1.6 cm)

MNSTR14 14" Dia. x 5/8" H
(35.6 x 1.6 cm)

MNSTR16 16" Dia. x 5/8" H
(40.6 x 1.6 cm)

Rectangle

MNST13 13 7/8" L x 10 1/8" W x 5/8" H
(35.2 x 25.7 x 1.6 cm)

MNST15 15 5/8" L x 11 3/4" W x 5/8" H
(39.7 x 29.8 x 1.6 cm)

MNST17 17 5/8" L x 13 1/4" W x 5/8" H
(44.8 x 33.7 x 1.6 cm)



Shown with CP9ST plate and MJ17 jar

SLIP-RESISTANT COATING
HELPS HOLD FOOD
AND DRINKS IN PLACE





THE FAUX SLATE COLLECTION

It's easy to mistake our Faux Slate Collection for the real thing, but take another look and you'll discover that these gorgeous pieces are actually crafted from durable, washable melamine. Accessorize your tabletops with these unique bowls, platters and peels.

White Square Faux Slate Melamine Bowls

- FSWMEL53** 23 oz. (680.2 mL)
5" Sq. x 2 7/8" H (12.7 x 7.3 cm)
- FSWMEL73** 58 oz. (1.7 L)
7" Sq. x 3 1/4" H (17.8 x 8.3 cm)
- FSWMEL94** 125 oz. (3.7 L)
9 1/2" Sq. x 4" H (24.1 x 10.2 cm)
- FSWMEL117** 208 oz. (6.2 L)
12" Sq. x 4 1/2" H (30.5 x 11.4 cm)

White Faux Slate Melamine Serving Peels

- FSRW9** 9" Dia. x 5/8" H, 12 5/8" L with Handle
(22.9 x 1.6, 32.1 cm)
- FSRW11** 12" Dia. x 5/8" H, 16 3/4" L with Handle
(30.5 x 1.5, 42.5 cm)
- FSRW14** 15" Dia. x 5/8" H, 20 3/4" L with Handle
(38.1 x 1.6, 52.7 cm)

White Faux Slate Flat Melamine Platters

- FSLW10** 10" L x 8 1/4" W x 1/4" H
(25.4 x 21 x 0.6 cm)
- FSLW08** 14 3/4" L x 8 1/4" W x 1/4" H
(37.5 x 21 x 0.6 cm)
- FSLW18** 18" L x 8 1/2" W x 1/4" H
(45.7 x 21.6 x 0.6 cm)
- FSLW14** 14 1/2" Sq. x 1/4" H
(36.8 x 0.6 cm)
- FSLW21** 21 1/2" L x 13" W x 1/4" H
(54.6 x 33 x 0.6 cm)



Black Faux Slate Melamine Platters

The chic texture of slate meets the durability of melamine with these stunning black trays, now with rims to help hold and showcase your latest menu creations.

- FSMEL12** 12" L x 7" W x 1 1/2" H
(30.5 x 17.8 x 3.8 cm)
- FSMEL19** 14" L x 7 1/2" W x 1 1/2" H
(35.6 x 19.1 x 3.8 cm)
- FSMEL23** 18" L x 8 1/4" W x 2" H
(45.7 x 21 x 5.1 cm)
- FSMEL21** 21" L x 13" W x 2" H
(53.3 x 33 x 5.1 cm)

Black Faux Slate Melamine Serving Peels

- FSR9** 9" Dia. x 5/8" H
12 5/8" L with Handle
(22.9 x 1.6, 32.1 cm)
- FSR11** 12" Dia. x 5/8" H
16 3/4" L with Handle
(30.5 x 1.6, 42.5 cm)
- FSR14** 15" Dia. x 5/8" H
20 3/4" L with Handle
(38.1 x 1.6, 52.7 cm)



FSMEL117



FSMEL94



FSMEL53



FSMEL73



Black Square Faux Slate Melamine Bowls

- FSMEL53** 23 oz. (680.2 mL)
5" Sq. x 2 7/8" H (12.7 x 7.3 cm)
- FSMEL73** 58 oz. (1.7 L)
7" Sq. x 3 1/4" H (17.8 x 8.3 cm)
- FSMEL94** 125 oz. (3.7 L)
9 1/2" Sq. x 4" H (24.1 x 10.2 cm)
- FSMEL117** 208 oz. (6.2 L)
12" Sq. x 4 1/2" H (30.5 x 11.4 cm)

Black Faux Slate Flat Melamine Platters HOT

- FSLT10** 10" L x 8 1/4" W x 1/4" H
(25.4 x 21 x 0.6 cm)
- FSLT08** 14 3/4" L x 8 1/4" W x 1/4" H
(37.5 x 21 x 0.6 cm)
- FSLT18** 18" L x 8 1/2" W x 1/4" H
(45.7 x 21.6 x 0.6 cm)
- FSLT14** 14 1/2" Sq. x 1/4" H
(36.8 x 0.6 cm)
- FSLT21** 21 1/2" L x 13" W x 1/4" H
(54.6 x 33 x 0.6 cm)

FSLT14

HOT



FSLT08 shown with MICH25, MICH10 milk cans

FSLT10

FSLT21

FSLT18

USE WITH SECURIT MARKERS-EASY TO IDENTIFY, SIMPLE TO WIPE CLEAN. SEE PG. 296-297



THE MELAMINE NATURALS COLLECTION

At first glance, these boards look like real stone and wood serving pieces. But upon closer examination, they're actually crafted from durable, dishwasher-safe melamine.

Dual-Tone Marble Melamine Serving Platters

For our next trick, we've created melamine serving boards that are practically indistinguishable from black-and-white marble. A high-end look that's guaranteed to turn heads.

Black/White Rectangular Platters

MWR15 14 1/2" L x 8 1/8" W x 1/2" H
(36.8 x 20.6 x 1.3 cm)

MWR18 18" L x 8 7/8" W x 1/2" H
(45.7 x 22.5 x 1.3 cm)

MWR21 21 3/8" L x 12 7/8" W x 1/2" H
(54.3 x 32.7 x 1.3 cm)

Black/Black Rectangular Platters

MBR15 14 1/2" L x 8 1/8" W x 1/2" H
(36.8 x 20.6 x 1.3 cm)

MBR18 18" L x 8 7/8" W x 1/2" H
(45.7 x 22.5 x 1.3 cm)

MBR21 21 3/8" L x 12 7/8" W x 1/2" H
(54.3 x 32.7 x 1.3 cm)





Shown with SVHT6 tongs



Shown with GVHT2 tongs

White Marble Melamine Platters

With an elegant marble finish, these bowls and platters are truly chic. They come in the same sizes as our traditional melamine bowls and platters with a modern shape.

- MWME12** 12" L x 7" W x 1 1/2" H (30.5 x 17.8 x 3.8 cm)
- MWME19** 14" L x 7 1/2" W x 1 1/2" H (35.6 x 19.1 x 3.8 cm)
- MWME23** 18" L x 8 1/4" W x 2" H (45.7 x 21 x 5.1 cm)
- MWME21** 21" L x 13" W x 2" H (53.3 x 33 x 5.1 cm)

White Marble Melamine Bowls

- MWMSQ5** 19 oz. (561.9 mL)
5" Sq. x 2 7/8" H (12.7 x 7.3 cm)
- MWMSQ7** 54 oz. (1.6 L)
7" Sq. x 3 1/4" H (17.8 x 8.3 cm)
- MWMSQ9** 127 oz. (3.8 L)
9 1/2" Sq. x 4" H (24.1 x 10.2 cm)
- MWMSQ11** 232 oz. (6.9 L)
12" Sq. x 4 1/2" H (30.5 x 11.4 cm)

Marble Melamine Serving Boards

White

- MW17** Organic
17 3/8" L x 9 7/8" W x 5/8" H
(44.1 x 25.1 x 1.6 cm)
- MW14** Round
14" Dia. x 1 1/8" H
(35.6 x 2.9 cm)
- MW25** Oval
25 1/2" L x 10 1/4" W x 1 1/8" H
(64.8 x 26 x 2.9 cm)
- MW171** Round
17 1/4" Dia. x 1 1/8" H
(43.8 x 2.9 cm)
- MW21** Round
21 1/2" Dia. x 1 1/8" H
(54.6 x 2.9 cm)

Black

- MB17** Organic
17 3/8" L x 9 7/8" W x 5/8" H
(44.1 x 25.1 x 1.6 cm)
- MB14** Round
14" Dia. x 1 1/8" H
(35.6 x 2.9 cm)
- MB25** Oval
25 1/2" L x 10 1/4" W x 1 1/8" H
(64.8 x 26 x 2.9 cm)
- MB171** Round
17 1/4" Dia. x 1 1/8" H
(43.8 x 2.9 cm)
- MB21** Round
21 1/2" Dia. x 1 1/8" H
(54.6 x 2.9 cm)

A PRACTICAL, STYLISH ALTERNATIVE
TO REAL MARBLE





Olive Wood Melamine Serving Boards

- OWM17** Organic
17 3/8" L x 9 7/8" W x 5/8" H
(44.1 x 25.1 x 1.6 cm)
- OWM14** Round
14" Dia. x 1 1/8" H
(35.6 x 2.9 cm)
- OWM25** Oval
25 1/2" L x 10 1/4" W x 1 1/8" H
(64.8 x 26 x 2.9 cm)
- OWM171** Round
17 1/4" Dia. x 1 1/8" H
(43.8 x 2.9 cm)
- OWM21** Round
21 1/2" Dia. x 1 1/8" H
(54.6 x 2.9 cm)

Olive Wood Melamine Serving Peels

- OWM12** Rectangular
12" L x 6" W x 1/2" H
17 1/2" L with Handle
(30.5 x 15.2 x 1.3, 44.5 cm)
- OWM10** Square
10" L x 9" W x 1/2" H
14 1/2" L with Handle
(25.4 x 22.9 x 1.3, 36.8 cm)



Rustic Wood Melamine Serving Boards

- MSR17** Organic
17 3/8" L x 9 7/8" W x 5/8" H
(44.1 x 25.1 x 1.6 cm)
- MSR14** Round
14" Dia. x 1 1/8" H
(35.6 x 2.9 cm)
- MSR25** Oval
25 1/2" L x 10 1/4" W x 1 1/8" H
(64.8 x 26 x 2.9 cm)
- MSR171** Round
17 1/4" Dia. x 1 1/8" H
(43.8 x 2.9 cm)
- MSR21** Round
21 1/2" Dia. x 1 1/8" H
(54.6 x 2.9 cm)

Rustic Wood Melamine Serving Peels

- MSR12** Rectangular
12" L x 6" W x 1/2" H
17 1/2" L with Handle
(30.5 x 15.2 x 1.3, 44.5 cm)
- MSR10** Square
10" L x 9" W x 1/2" H
14 1/2" L with Handle
(25.4 x 22.9 x 1.3, 36.8 cm)





RMB14

RMB11

RMB12

Shown with GVHT2 tongs

Reclaimed Wood Melamine Serving Bowls

We took the natural styling of our Reclaimed Wood Melamine Serving Boards and applied it to bowls, creating a great opportunity for cohesive presentation. The exterior of the bowls is wood-textured to complement the unique faux-weathered interior.

RMB11 97 oz. (2.9 L)
11" Dia. x 3 1/8" H
(27.9 x 7.9 cm)

RMB12 137 oz. (4 L)
12 3/4" Dia. x 3 3/8" H
(32.4 x 8.6 cm)

RMB14 235 oz. (6.9 L)
14 3/4" Dia. x 3 1/2" H
(37.5 x 8.9 cm)

Reclaimed Wood Melamine Serving Boards

The on-trend look of reclaimed wood meets the durable functionality of melamine with our serving boards, peels and risers. All of the style, none of the impracticality.

RM17 Organic
17 3/8" L x 9 7/8" W x 5/8" H
(44.1 x 25.1 x 1.6 cm)

RM14 Round
14" Dia. x 1 1/8" H
(35.6 x 2.9 cm)

RM25 Oval
25 1/2" L x 10 1/4" W x 1 1/8" H
(64.8 x 26 x 2.9 cm)

RM21 Round
21 1/2" Dia. x 1 1/8" H
(54.6 x 2.9 cm)



RM14

RM25

RM21

RM17

Reclaimed Wood Melamine Serving Peels

RM12 Rectangular
12" L x 6" W x 1/2" H
17 1/2" L with Handle
(30.5 x 15.2 x 1.3, 44.5 cm)

RM10 Square
10" L x 9" W x 1/2" H
14 1/2" L with Handle
(25.4 x 22.9 x 1.3, 36.8 cm)



RM12

RM10



**Reclaimed Wood
Melamine Serving Boards**

- RM147** Rectangular
14 1/4" L x 8" W x 3/8" H
(36.2 x 20.3 x 1 cm)
- RM189** Rectangular
17 3/4" L x 8 3/4" W x 3/8" H
(45.1 x 22.2 x 1 cm)
- RM2113** Rectangular
21 3/8" L x 12 3/4" W x 3/8" H
(54.2 x 32.4 x 1 cm)
- RM1614** Organic Round
16 3/8" L x 14 5/8" W x 5/8" H
(41.6 x 37.1 x 1.6 cm)
- RM210** Organic Oblong
21 1/4" L x 10 5/8" W x 5/8" H
(54 x 27 x 1.6 cm)



**Reclaimed Wood
Melamine Risers**

- RM95** Round
10 1/8" Dia. x 2 1/8" H
(25.7 x 5.4 cm)
- RM13** Rectangular
12 1/4" L x 6 3/4" W x 2" H
(31.1 x 17.1 x 5.1 cm)





ROUND AND OVAL SERVING BOARDS FEATURE INCONSPICUOUS 1 1/8" FEET FOR CONVENIENT SERVING

PERFECT FOR FARM-TO-TABLE



Acacia Melamine Serving Boards

- AWM17** Organic
17 3/8" L x 9 7/8" W x 5/8" H
(44.1 x 25.1 x 1.6 cm)
- AWM14** Round
14" Dia. x 1 1/8" H
(35.6 x 2.9 cm)
- AWM25** Oval
25 1/2" L x 10 1/4" W x 1 1/8" H
(64.8 x 26 x 2.9 cm)
- AWM171** Round
17 1/4" Dia. x 1 1/8" H
(43.8 x 2.9 cm)
- AWM21** Round
21 1/2" Dia. x 1 1/8" H
(54.6 x 2.9 cm)

Acacia Melamine Serving Peels

- AWM12** Rectangular
12" L x 6" W x 1/2" H
17 1/2" L with Handle
(30.5 x 15.2 x 1.3, 44.5 cm)
- AWM10** Square
10" L x 9" W x 1/2" H
14 1/2" L with Handle
(25.4 x 22.9 x 1.3, 36.8 cm)



Greystone Melamine Serving Boards

Your customers will swear that these brand-new melamine serving boards and risers are chiseled from stone.

GM1614 Organic Round
16 3/8" L x 14 5/8" W x 5/8" H
(41.6 x 37.1 x 1.6 cm)

GM210 Organic Oblong
21 1/4" L x 10 5/8" W x 5/8" H
(54 x 27 x 1.6 cm)

GM147 Rectangular
14 1/4" L x 8" W x 3/8" H
(36.2 x 20.3 x 1 cm)

GM189 Rectangular
17 3/4" L x 8 3/4" W x 3/8" H
(45.1 x 22.2 x 1 cm)

GM2113 Rectangular
21 3/8" L x 12 3/4" W x 3/8" H
(54.2 x 32.4 x 1 cm)

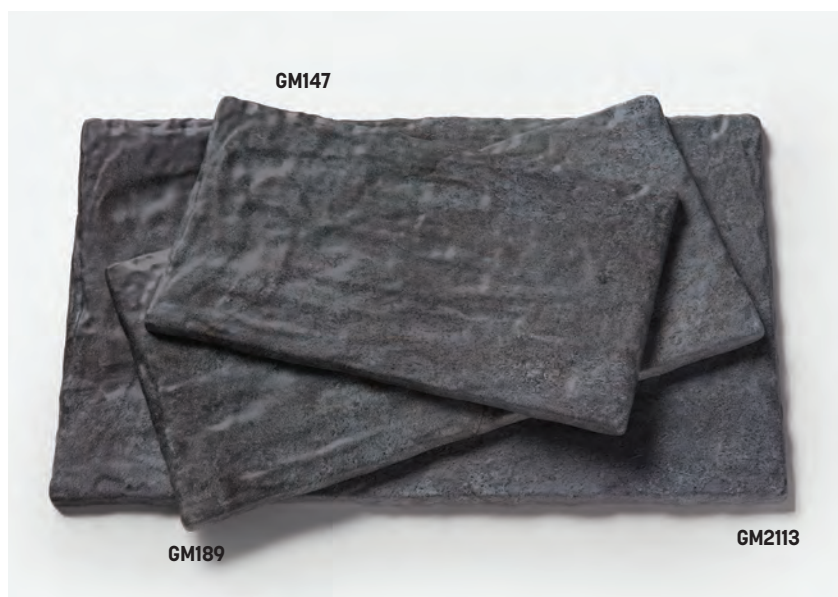

Greystone Melamine Risers

GM95 Round
10 1/8" Dia. x 2 1/8" H
(25.7 x 5.4 cm)

GM13 Rectangular
12 1/4" L x 6 3/4" W x 2" H
(31.1 x 17.1 x 5.1 cm)



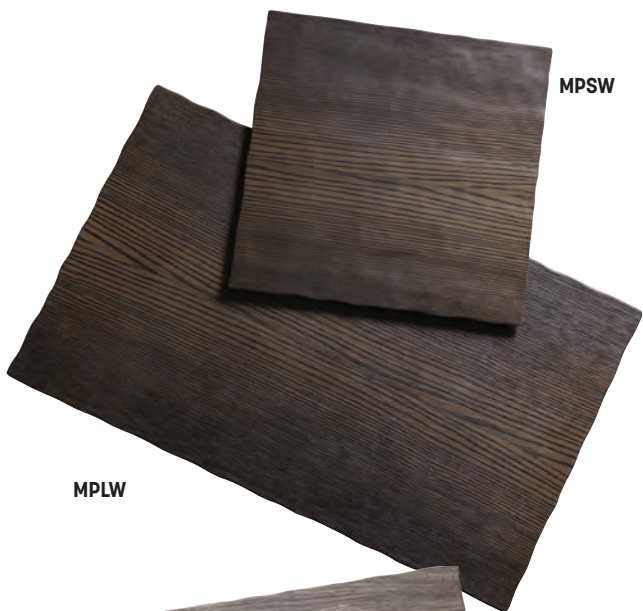

MPLW

MPSW

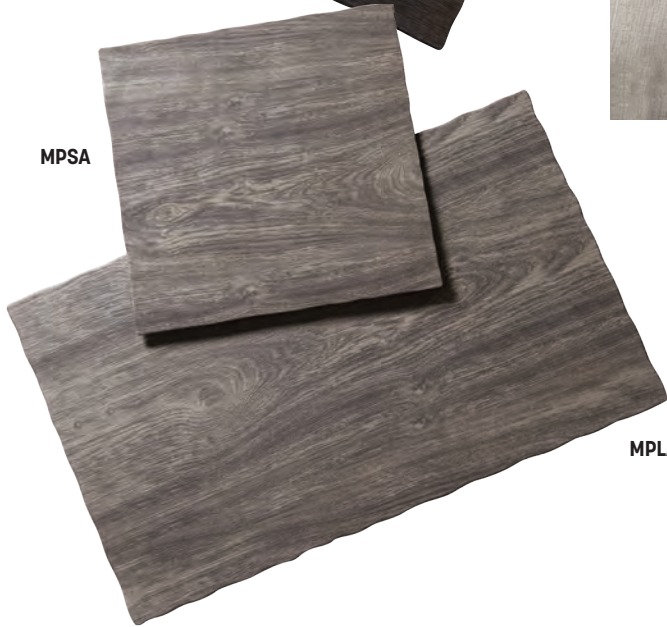

MPSA

MPLA



MPLB

MPSB

Melamine Serving Boards

Bamboo

- MPSB** Square
11 1/4" Sq. x 3/8" H
(28.6 x 1 cm)
- MPLB** Rectangular
20 7/8" L x 12 1/2" W x 3/8" H
(53 x 31.8 x 1 cm)

Walnut

- MPSW** Square
11 1/4" Sq. x 3/8" H
(28.6 x 1 cm)
- MPLW** Rectangular
20 7/8" L x 12 1/2" W x 3/8" H
(53 x 31.8 x 1 cm)

Elm

- MPSA** Square
11 1/4" Sq. x 3/8" H
(28.6 x 1 cm)
- MPLA** Rectangular
20 7/8" L x 12 1/2" W x 3/8" H
(53 x 31.8 x 1 cm)

Rectangular Walnut Melamine Platters

- WMEL19** 14 1/4" L x 7 1/2" W x 1 1/2" H
(36.2 x 19.1 x 3.8 cm)
- WMEL23** 18" L x 8 1/4" W x 2" H
(45.7 x 21 x 5.1 cm)
- WMEL21** 21" L x 13" W x 2" H
(53.3 x 33 x 5.1 cm)



WMEL21

WMEL23

WMEL19
shown with
TSCB15, TSCB4
sauce cups



Tapered Birch Bread Baskets

Available in our most popular sizes, these real wooden pieces perform double duty as baskets or risers. Clear disposable liners fit each basket.

- TWBB53** 5" Sq. x 3" H
(12.7 x 7.6 cm)
- TWBB73** 7" Sq. x 3 ¼" H
(17.8 x 8.3 cm)
- TWBB94** 9 ½" Sq. x 4" H
(24.1 x 10.2 cm)
- TWBB124** 12" Sq. x 4 ½" H
(30.5 x 11.4 cm)
- TWBREC** 9 ¼" L x 6 ¼" W x 3" H
(23.5 x 15.9 x 7.6 cm)

Disposable Liners

- PBSL53** 23 oz. (680.2 mL)
5" x 3" H
(12.7 x 7.6 cm)
PET Liner for TWBB53
- PBSL73** 58 oz. (1.7 L)
7" Sq. x 3 ¼" H
(17.8 x 8.3 cm)
PET Liner for TWBB73
- PBSL94** 125 oz. (3.7 L)
9 ½" Sq. x 4" H
(24.1 x 10.2 cm)
PET Liner for TWBB94
- PBSL124** 228 oz. (6.7 L)
12" x 4 ½" H
(24.1 x 10.2 cm)
PET Liner for TWBB124
- PBSLREC** 48 oz. (1.4 L)
9 ¾" L x 6 ¾" W x 3" H
(23.8 x 16.2 x 7.6 cm)
PET Liner for TWBREC





HOT

BWB109

BWB105

Shown with BHCHD1, BHCHL1 card holders and TAGA7WT mini chalk cards

CRAB CAKES
with
REMOULADE

TWO-SIDED FOR
VERSATILE REVERSABILITY

BWB185

BWB189



BWF4

Shown with
GMB8 glass
milk bottles

THE BAMBOO COLLECTION

Go green without sacrificing looks with environmentally friendly bamboo. Warm wood-like tones make this collection a casual way to elevate breakfast buffets, catering, room service and more.

Carbonized Bamboo Serving Boards HOT 🔥

BWB105 10" L x 5 3/4" W x 3/4" H
(25.4 x 14.6 x 1.9 cm)

BWB109 10" L x 9" W x 3/4" H
(25.4 x 22.9 x 1.9 cm)

BWB185 18 1/4" L x 5 3/4" W x 3/4" H
(46.4 x 14.6 x 1.9 cm)

BWB189 18 1/4" L x 9" W x 3/4" H
(46.4 x 22.9 x 1.9 cm)

Carbonized Bamboo Flight Boards 🔥

BWF4 Flight Board
13 7/8" L x 3 3/8" W x 1 1/4" H
(35.2 x 8.6 x 3.2 cm)

BWF3 Pairing Flight Board
13 7/8" L x 6 7/8" W x 1 1/4" H
(35.2 x 17.5 x 3.2 cm)



Shown with
MP6 melamine
paper plate and
GMB8 glass milk
bottles

BWF3



BWBO shown with MB4 sauce cup

Shown with GMB8 milk bottles

BWBR

Carbonized Bamboo Serving Peels and Boards

Serving Boards

BWBR Round
9" Dia. x ¾" H
(22.9 x 1.9 cm)

BWBO Oblong
13 ½" L x 6" W x ¾" H
(34.3 x 15.2 x 1.9 cm)

Serving Peels

BWBS Rectangular
9 ¼" L x 5" W x ¾" H
13 ¼" L with Handle
(23.5 x 12.7 x 1.9, 33.7 cm)

BWBL Rectangular
15" L x 7" W x ¾" H
19" L with Handle
(38.1 x 17.8 x 1.9, 48.3 cm)



Shown with HMMJ5 apothecary jar

BWBL

ALL OF OUR CARBONIZED SERVING PIECES FEATURE A RICH WOOD PATINA THAT IS LIGHT BROWN ON ONE SIDE AND DARK BROWN ON THE OTHER

BWBS shown with CKNF2 cheese knife



BAM18 shown with
PBSL2 liner and
FRYR375 fry basket

BAM1812

BAM22

BAM14

Rectangular Bamboo Trays

- BAM14** 14 ¼" L x 7 ½" W x 1 ½" H
(36.2 x 19.1 x 3.8 cm)
- BAM18** 18" L x 8 ¼" W x 2" H
(45.7 x 21 x 5.1 cm)
- BAM1812** 18" L x 12" W x 2" H
(45.7 x 30.5 x 5.1 cm)
- BAM22** 21" L x 13" W x 2" H
(53.3 x 33 x 5.1 cm)

Disposable Liners

- PBSL1** 13 ¾" L x 7 ¼" W x 1" H
(34.9 x 18.4 x 2.5 cm)
PET Liner for BAM14
- PBSL2** 17 ½" L x 8 ¾" W x 2" H
(44.5 x 22.2 x 5.1 cm)
PET Liner for BAM18
- PBSL3** 19 ½" L x 12" W x 2" H
(49.5 x 30.5 x 5.1 cm)
PET Liner for BAM22

Flat Bamboo Platters

- BAM148** 14 ½" L x 8 ¼" W x ¾" H
(36.8 x 21 x 2.2 cm)
- BAM189** 18 ¼" L x 9" W x ¾" H
(46.4 x 22.9 x 2.2 cm)
- BAM141** 14 ¾" Sq. x ¾" H
(36.5 x 2.2 cm)
- BAM211** 21 ½" L x 13" W x ¾" H
(54.6 x 33 x 2.2 cm)



BAM211

BAM148

BAM189

BAM141

Round Bamboo Butcher Blocks

- B10** 10" Dia. x 1 1/2" H
(25.4 x 3.8 cm)
- B12** 12" Dia. x 1 1/2" H
(30.5 x 3.8 cm)
- B14** 14" Dia. x 1 1/2" H
(35.6 x 3.8 cm)
- B16** 16" Dia. x 1 1/2" H
(40.6 x 3.8 cm)



Square Bamboo Bowls

- BAM53** 23 oz. (608.2 L)
5" Sq. x 3" H
(12.7 x 7.6 cm)
- BAM73** 58 oz. (1.7 L)
7" Sq. x 3 1/4" H
(17.8 x 8.3 cm)
- BAM94** 125 oz. (3.7 L)
9 1/2" Sq. x 4" H
(24.1 x 10.2 cm)
- BAM124** 202 oz. (6 L)
12" Sq. x 4 1/2" H
(30.5 x 11.4 cm)

Disposable Liners

- PBSL53** 23 oz. (608.2 mL)
5" Sq. x 3" H (12.7 x 7.6 cm)
PET Liner for BAM53
- PBSL73** 58 oz. (1.7 L)
7" Sq. x 3 1/4" H (17.8 x 8.3 cm)
PET Liner for BAM73
- PBSL94** 125 oz. (3.7 L)
9 1/2" Sq. x 4" H (24.1 x 10.2 cm)
PET Liner for BAM94
- PBSL124** 228 oz. (6.7 L)
12" Sq. x 4 1/2" H (30.5 x 11.4 cm)
PET Liner for BAM124



Angled Bamboo Bowls

- BAMSL52** 8 oz. (236.6 mL)
5" Dia. x 3 1/2" H
(12.7 x 8.9 cm)
- BAMSL82** 22 oz. (650.6 mL)
8 1/4" Dia. x 5 3/8" H
(21 x 13.7 cm)
- BAMSL92** 48 oz. (1.4 L)
9 3/4" Dia. x 6 1/8" H
(24.8 x 15.6 cm)
- BAMSL112** 80 oz. (2.4 L)
11 1/2" Dia. x 7 1/4" H
(29.2 x 18.4 cm)





THE ASH WOOD COLLECTION

These ash wood boards and peels feature rich patterns, earthy looks and unique handle designs. From charcuterie to single serving sandwiches, there's a size for every need. See pg. 438-439 for special care instructions.

Short-Handle Ash Wood Serving Peels

- AWB14** 8" W x 9" L Blade, 14" with Handle
(20.3 x 22.8, 35.5 cm)
- AW2212** 12" W x 13" L Blade, 22" with Handle
(30.4 x 33, 55.8 cm)
- AW2414** 14" W x 15" L Blade, 24" with Handle
(35.5 x 38.1, 60.9 cm)
- AW2616** 16" W x 17" L Blade, 26" with Handle
(40.6 x 43.1, 66 cm)

Rimmed Oval Ash Wood Serving Boards

- AWB7** 7" L x 4" W x ¾" H
(17.7 x 10.1 x 1.9 cm)
- AWB10** 9" L x 6" W x ¾" H
(22.8 x 15.2 x 1.9 cm)
- AWB12** 12" L x 9" W x ¾" H
(22.8 x 15.2 x 1.9 cm)

Rimmed Ash Wood Serving Boards

- AWB147** 14" L x 7" W x ¾" H
(35.6 x 17.8 x 1.9 cm)
- AWB1210** 12" L x 10" W x ¾" H
(30.5 x 25.4 x 1.9 cm)

Ash Wood Rectangular Serving Boards

- AWB1016** 16" L x 10" W x ¾" H
(40.6 x 25.4 x 1.9 cm)
- AWB621** 21" L x 6" W x ¾" H
(53.3 x 15.2 x 1.9 cm)
- AWB1021** 21" L x 10" W x ¾" H
(53.3 x 25.4 x 1.9 cm)

Ash Wood Serving Peels

- AWB617** 12" L x 6" W x ¾" H, 17" L with Handle
(30.5 x 15.2 x 1.9, 43.2 cm)
- AWB179** 12" L x 9" W x ¾" H, 17" L with Handle
(30.5 x 22.9 x 1.9, 43.2 cm)



AWB1210

AWB147



AWB1021

AWB1016

AWB621

Shown with
HCHL1 hammered
card holder and
TAGA8WT mini
chalk card



AWB617

AWB179



THE OLIVE WOOD COLLECTION

Whether you choose our striking geometric style or our wavy organic style, you'll have a board with gorgeous marbling and memorable design.

Short-Handle Olive Wood Serving Peels

- OWP9** 8" W x 9" L Blade
14" with Handle
(20.3 x 22.8, 35.5 cm)
- OWP13** 12" W x 13" L Blade
22" with Handle
(30.4 x 33, 55.8 cm)
- OWP15** 14" W x 15" L Blade
24" with Handle
(35.5 x 38.1, 60.9 cm)
- OWP17** 16" W x 17" L Blade
26" with Handle
(40.6 x 43.1, 66 cm)

Olive Wood Serving Peels

- OWB116** 9 1/4" L x 6" W x 5/8" H
10 3/4" L with Handle
(23.5 x 15.2 x 1.6, 27.3 cm)
- OWB117** 9 3/8" L x 5 3/4" W x 5/8" H
12 1/8" L with Handle
(23.8 x 14.6 x 1.6, 30.8 cm)
- OWB118** 13 7/8" L x 5 7/8" W x 5/8" H
16 1/8" L with Handle
(35.2 x 14.9 x 1.6, 41.1 cm)
- OWB149** 9 7/8" L x 9 1/8" W x 5/8" H
14" L with Handle
(25.1 x 23.2 x 1.6, 35.6 cm)

Organic Olive Wood Serving Peels

- OWP157** 10 3/4" L x 7" W x 3/4" H
14 3/4" L with Handle
(27.3 x 17.8 x 1.9, 37.5 cm)
- OWP178** 12 1/8" L x 7 3/4" W x 3/4" H
17 3/8" L with Handle
(30.8 x 19.7 x 1.9, 44.1 cm)





Olive Wood Polyresin Serving Boards

A showstopping way to serve hors d'oeuvres and charcuteries. These high-end, food-safe serving boards infuse stunning olive wood with a streak of vibrant blue polyresin.

- OWP14** 14" L x 7" W x $\frac{5}{8}$ " H
(35.6 x 17.8 x 1.6 cm)
- OWP12** 12" L x 10" W x $\frac{5}{8}$ " H
(30.5 x 25.4 x 1.6 cm)
- OWP18** 18" L x 10" W x $\frac{5}{8}$ " H
(45.7 x 25.4 x 1.6 cm)

Large Olive Wood Serving Boards

- OWB1810** 18" L x 8 $\frac{3}{4}$ " W x $\frac{3}{4}$ " H
(45.7 x 22.2 x 1.9 cm)
- OWB208** 20" L x 8" W x $\frac{3}{4}$ " H
(50.8 x 20.3 x 1.9 cm)
- OWB2213** 22" L x 13" W x $\frac{3}{4}$ " H
(55.9 x 33 x 1.9 cm)



Shown with HMMJ3, HMMJ2, HMMJ5 apothecary jars

OWB1810 on GJ24 glass jar risers

OWB2213

OWB208

Shown with GJ8 glass jars



OWB107

OWB129

Shown with
MJ17 and GJ6
glass jars

Olive Wood Serving Boards

OWB107 10" L x 7" W x ¾" H
(25.4 x 17.8 x 1.9 cm)

OWB129 12" L x 7 ¾" W x ¾" H
(30.5 x 19.7 x 1.9 cm)

Oblong Olive Wood Boats

OWSP 12" L x 4 ½" W x 1" H
(30.5 x 11.4 x 2.5 cm)

OWMP 17 ¾" L x 5 ¼" W x 1 ¼" H
(45.1 x 13.3 x 3.2 cm)

OWLP 23 ⅝" L x 5 ⅞" W x 1 ¼" H
(60 x 14.9 x 3.2 cm)



OWMP

OWLP

OWSP



Oval Olive Wood Serving Boards

OWPB9 9 7/8" L x 5 7/8" W x 1/2" H
(25.1 x 14.9 x 1.3 cm)

OWPB16 16 1/8" L x 7 1/8" W x 1/2" H
(41 x 18.1 x 1.3 cm)

Olive Wood Bread Crates

OWBB1 8 1/2" L x 4" W x 2 3/8" H
(21.6 x 10.2 x 6 cm)

OWBB2 7 3/4" L x 6" W x 2 3/8" H
(19.7 x 15.2 x 6 cm)

Olive Wood/Marble Serving Peels

Gray Marble

OWBG8 6" L x 3 1/2" W x 1/2" H
8" L with Handle
(15.2 x 8.9 x 1.3, 20.3 cm)

OWBG9 5 5/8" L x 5 1/4" W x 1/2" H
9" L with Handle
(14.3 x 13.3 x 1.3, 22.9 cm)

OWBG15 10" L x 9" W x 1/2" H
14 3/4" L with Handle
(25.4 x 22.9 x 1.3, 37.5 cm)

Black Marble

OWBB8 6" L x 3 1/2" W x 1/2" H
8" L with Handle
(15.2 x 8.9 x 1.3, 20.3 cm)

OWBB9 5 5/8" L x 5 1/4" W x 1/2" H
9" L with Handle
(14.3 x 13.3 x 1.3, 22.9 cm)

OWBB15 10" L x 9" W x 1/2" H
14 3/4" L with Handle
(25.4 x 22.9 x 1.3, 37.5 cm)





USA

MBM4 shown with GJ6 jar

Maple Pressed Wood Serving Peels ^{USA}

A beautiful maple veneer gives these peels the look and feel of wood, but they're also dishwasher-safe. Use them anywhere you'd use a traditional plate.

Rectangular

- MBM2** 12 1/2" L x 4 3/8" W x 1/4" H
18" L with Handle
(31.8 x 11.1 x 0.6, 45.7 cm)
- MBM3** 12 1/2" L x 6 1/2" W x 1/4" H
18" L with Handle
(31.8 x 16.5 x 0.6, 45.7 cm)
- MBM4** 13" L x 8 1/8" W x 1/4" H
18" L with Handle
(33 x 20.6 x 0.6, 45.7 cm)

Round

- MBM115** 11 1/2" Dia. x 1/4" H
21 1/2" L with Handle
(29.2 x 0.6, 54.6 cm)
- MBM155** 15 1/2" Dia. x 1/4" H
25 1/2" L with Handle
(39.4 x 0.6, 64.8 cm)
- MBM180** 18" Dia. x 1/4" H
28 1/2" L with Handle
(45.7 x 0.6, 72.4 cm)



USA

MBM4

MBM3

MBM2



USA

MBM115

MBM155

MBM180

REPLACE TRADITIONAL PLATES WITH CREATIVE SERVING PEELS

Rectangular Pressed Wood Serving Peels ^{USA}

Made of a pressed wood material, these peels should overcome all objections health departments have with traditional wood peels.

Natural

- MPG2** 12 ½" L x 4 ¾" W x ¼" H
18" L with Handle
(31.8 x 11.1 x 0.6, 45.7 cm)
- MPG3** 12 ½" L x 6 ½" W x ¼" H
18" L with Handle
(31.8 x 16.5 x 0.6, 45.7 cm)
- MPG4** 13" L x 8 ⅛" W x ¼" H
18" L with Handle
(33 x 20.6 x 0.6, 45.7 cm)

Black

- MPB2** 12 ½" L x 4 ¾" W x ¼" H
18" L with Handle
(31.8 x 11.1 x 0.6, 45.7 cm)
- MPB3** 12 ½" L x 6 ½" W x ¼" H
18" L with Handle
(31.8 x 16.5 x 0.6, 45.7 cm)
- MPB4** 13" L x 8 ⅛" W x ¼" H
18" L with Handle
(33 x 20.6 x 0.6, 45.7 cm)





Black Pressed Wood Serving Boards ^{USA}

Made of NSF-and USDA-listed material, these black serving boards are the perfect companion to our Mega Flatbread Screens.

- MPSB11** 11" L x 7" W x ¼" H (27.9 x 17.8 x 0.6 cm)
- MPSB16** 16" L x 8" W x ¼" H (40.6 x 20.3 x 0.6 cm)
- MPSB17** 17" L x 9" W x ¼" H (43.2 x 22.9 x 0.6 cm)
- MPSB20** 20" L x 9" W x ¼" H (50.8 x 22.9 x 0.6 cm)

Maple Pressed Wood Serving Boards ^{USA}

A beautiful maple veneer gives these boards the look and feel of wood, but they're also dishwasher-safe. Perfect for flatbreads

- MBSB11** 11" L x 7" W x ¼" H (27.9 x 17.8 x 0.6 cm)
- MBSB16** 16" L x 8" W x ¼" H (40.6 x 20.3 x 0.6 cm)
- MBSB17** 17" L x 9" W x ¼" H (43.2 x 22.9 x 0.6 cm)
- MBSB20** 19" L x 9" W x ¼" H (45.7 x 22.9 x 0.6 cm)

NAFTA



Rectangular Wood Serving Peels



- MSB2** 12 ½" L x 4 ¾" W x ¼" H
18" L with Handle
(31.8 x 11.1 x 0.6, 45.7 cm)
- MSB3** 12 ½" L x 6 ½" W x ¼" H
18" L with Handle
(31.8 x 16.5 x 0.6, 45.7 cm)
- MSB4** 13" L x 8 ⅛" W x ¼" H
18" L with Handle
(33 x 20.6 x 0.6, 45.7 cm)

Heavy Rubber Wood Bread Boards



- BB812** 9" L x 8 ⅛" W x ¾" H
12 ½" L with Handle
(22.9 x 20.6 x 1.9, 31.8 cm)
- BB816** 10 ⅞" L x 8 ⅛" W x ¾" H
16 ¼" L with Handle
(25.7 x 20.6 x 1.9, 41.3 cm)

BB816



BB812

STYLISH ENOUGH FOR
FRONT-OF-HOUSE,
DURABLE ENOUGH FOR
BACK-OF-HOUSE



HOT

SB7

SB5

SB3



SB575

SB450

SB400

SB325

Squound Stainless Steel Bowls HOT

Pair stainless steel with cutting-edge shapes, and you get some of the most contemporary serving bowls on the market.

- SB3** 40 oz. (1.2 L)
7" Dia. x 2 1/8" H (17.8 x 5.4 cm)
- SB5** 67 oz. (2 L)
9" Dia. x 2 3/4" H (22.9 x 7 cm)
- SB7** 126 oz. (3.7 L)
11" Dia. x 3" H (27.9 x 7.6 cm)

Squound Stainless Steel Snack Bowls

- SB325** 3 oz. (88.7 mL)
3 1/8" Dia. x 1 1/2" H (7.9 x 3.8 cm)
- SB400** 5 1/2 oz. (162.7 mL)
3 1/4" Dia. x 1 1/2" H (8.3 x 3.8 cm)
- SB450** 9 1/2 oz. (280.9 mL)
4 1/2" Dia. x 2 1/2" H (11.4 x 6.4 cm)
- SB575** 15 oz. (443.6 mL)
5 3/4" Dia. x 2 1/2" H (14.6 x 6.4 cm)



SB1

Round Checker Bowl

With tasteful square cutouts, this brushed stainless steel bowl is a great way to add instant intrigue to baked goods.

- SB1** Checker
8" Dia. x 3 5/8" H (20.3 x 9.2 cm)



Squound Hammered Bowls

SBH3	40 oz. (1.2 L) 7" Dia. x 2 1/8" H (17.8 x 5.4 cm)
SBH5	67 oz. (2 L) 9" Dia. x 2 3/4" H (22.9 x 7 cm)
SBH7	126 oz. (3.7 L) 11" Dia. x 3" H (27.9 x 7.6 cm)

Squound Hammered Snack Bowls

SBH325	3 oz. (88.7 mL) 3 1/8" Dia. x 1 1/2" H (7.9 x 3.8 cm)
SBH400	5 1/2 oz. (162.7 mL) 3 1/4" Dia. x 1 1/2" H (8.3 x 3.8 cm)
SBH450	9 1/2 oz. (280.9 mL) 4 1/2" Dia. x 2 1/2" H (11.4 x 6.4 cm)
SBH575	15 oz. (443.6 mL) 5 3/4" Dia. x 2 1/2" H (14.6 x 6.4 cm)



Shown with MSTNG5 tongs

Moroccan Hammered Bowls

These one-of-a-kind stainless steel bowls are great serving vessels for global cuisine and practically anything else.

HB5	16 oz. (473.2 mL) 5" Dia. x 2" H (12.7 x 5.1 cm)
HB6	27 oz. (798.5 mL) 6" Dia. x 2 1/2" H (15.2 x 6.4 cm)
HB7	38 oz. (1.1 L) 6 3/4" Dia. x 2 3/4" H (17.1 x 7 cm)



Shown with SPM4 S&P shakers

Shown with FFCS45 fry cup,
PPRN76 paper bag and
SPLB6 S&P shakers



ST10

ST20

ST12

Satin Finish Stainless Steel Trays with Sides

- ST10 10" L x 4 1/2" W x 1/2" H
(25.4 x 11.4 x 1.3 cm)
- ST12 12" L x 8 1/4" W x 1/2" H
(30.5 x 21 x 1.3 cm)
- ST20 20 1/8" L x 4 1/2" W x 1/2" H
(51.1 x 11.4 x 1.3 cm)

Royal Touch™ Round Serving Trays

The name says it all. These heavy-duty stainless steel trays elevate catered events to glamorous affairs.

- SST10 10" Dia. x 1/2" H
(25.4 x 1.3 cm)
- SST12 12" Dia. x 1/2" H
(30.5 x 1.3 cm)
- SST14 14" Dia. x 1/2" H
(35.6 x 1.3 cm)



SST14

SST12

SST10

THE HAMMERED COLLECTION

Snowflakes, fingerprints and pieces from our Hammered Collection. The connection? Each is one-of-a-kind. These stainless steel trays and bowls are individually hammered with a ball-peen hammer so that each is uniquely stunning.

Hammered Stainless Steel Trays with Sides

HMST10 10" L x 4 1/2" W x 1/2" H
(25.4 x 11.4 x 1.3 cm)

HMST12 12" L x 8 1/4" W x 1/2" H
(30.5 x 21 x 1.3 cm)

HMST20 20 1/8" L x 4 1/2" W x 1/2" H
(51.1 x 11.4 x 1.3 cm)

Hammered Stainless Steel Sheet Pans

Prep, store and serve, all with one super-versatile pan. From the kitchen to the dining room, this jack-of-all-trades gets the job done.

HMSP1813 Half-Size
18" L x 13" W x 1" H
(45.7 x 33 x 2.5 cm)

HMSP2618 Full-Size
26" L x 18" W x 1" H
(66 x 45.7 x 2.5 cm)



IN YOUR CHOICE OF FULL AND
HALF SIZES THAT STORE EASILY
IN YOUR EVERYDAY SPEED RACK

HMRD16



HMRD08



HMRD12



Round Hammered Bowls

- HMRD08** 34 oz. (1 L)
8 1/2" Dia. x 1 5/8" H (21.6 x 4.1 cm)
- HMRD12** 85 oz. (2.5 L)
12 1/8" Dia. x 2 1/4" H (30.8 x 5.7 cm)
- HMRD16** 168 oz. (5 L)
16 1/4" Dia. x 2 3/4" H (41.3 x 7 cm)

Oval Hammered Trays

- HMOST1115** 15" L x 11" W x 3/4" H
(38.1 x 27.9 x 1.9 cm)
- HMOST1317** 17 1/4" L x 13 1/4" W x 1 1/8" H
(43.8 x 33.7 x 2.9 cm)
- HMOST1520** 20" L x 15 1/2" W x 1 1/8" H
(50.8 x 39.4 x 2.9 cm)

Oval Hammered Bowls

- HMOV1418** 144 oz. (4.3 L)
18 5/8" L x 14 1/4" W x 2 1/2" H
(47.3 x 36.2 x 6.4 cm)
- HMOV1621** 192 oz. (5.7 L)
20 1/8" L x 16 1/4" W x 3 1/2" H
(51.1 x 41.3 x 8.9 cm)

HMOST1520



HMOST1317



HMOST1115



HMOV1621



HMOV1418





Square Hammered Trays

HMSQ12	12" Sq. x 1" H (30.5 x 2.5 cm)
HMSQ14	14" Sq. x 1" H (35.6 x 2.5 cm)
HMSQ16	16" Sq. x 1 1/8" H (40.6 x 2.9 cm)
HMSQ18	18" Sq. x 1 1/8" H (45.7 x 2.9 cm)
HMSQ20	20" Sq. x 1 1/8" H (50.8 x 2.9 cm)
HMSQ22	22" Sq. x 1 1/8" H (55.9 x 2.9 cm)

Rectangular Hammered Trays

HMRT712	11 3/8" L x 7 3/8" W x 1" H (28.9 x 18.7 x 2.5 cm)
HMRT814	14 1/8" L x 7 5/8" W x 1" H (35.9 x 19.4 x 2.5 cm)
HMRT1019	18 5/8" L x 9 5/8" W x 1 3/8" H (47.3 x 24.4 x 3.5 cm)
HMRT1322	21 3/4" L x 12 3/4" W x 1 5/8" H (55.2 x 32.4 x 3.8 cm)





From top to bottom:
HMRST1801
HMRST2001
HMRST2201

HMRST1401

HMRST1601



HMRST1301
shown
on SSUS1
riser

HMRT1611

HMRT247

Round Hammered Trays

- HMRST1401** 14" Dia. x 1 1/8" H
(35.6 x 2.9 cm)
- HMRST1601** 16" Dia. x 1 1/8" H
(40.6 x 2.9 cm)
- HMRST1801** 18" Dia. x 1 1/8" H
(45.7 x 2.9 cm)
- HMRST2001** 20" Dia. x 1 1/8" H
(50.8 x 2.9 cm)
- HMRST2201** 22" Dia. x 1 1/8" H
(55.9 x 2.9 cm)

Rectangular and Round Hammered Trays

- HMRT1611** Rectangular
16 5/8" L x 11 1/4" W x 3/8" H
(42.2 x 28.6 x 1 cm)
- HMRST1301** Round
78 oz. (2.3 L), 13 3/8" Dia. x 1 3/8" H
(34 x 3.5 cm)
- HMRT247** Rectangular
23 3/4" L x 7 1/2" W x 1/2" H
(60.3 x 19 x 1.3 cm)

USE THESE TO STAGE CLASSIC ENTRÉES OR AVANT-GARDE HORS D'OEUVRES; THESE PIECES FROM OUR HAMMERED COLLECTION RAISE CULINARY CREATIONS TO A HIGHER STANDARD OF ARTISTRY



Hammered Stainless Steel Serving Pans

- THRD17** Round
144 oz. (4.3 L)
15" Dia. x 2 1/4" H
17" Dia. with Handles
(38.1 x 5.7, 43.2 cm)
- THOV19** Oval
128 oz. (3.8 L)
18 1/4" L x 12 3/8" W x 2" H
20" L with Handles
(46.4 x 31.4 x 5.1, 50.8 cm)
- THRC21** Rectangular
168 oz. (5 L)
18 1/4" L x 14" W x 2" H
20 1/8" L with Handles
(46.4 x 35.6 x 5.1, 51.1 cm)



Stainless Steel Square Bowls

Hammered

- SSQH53** 30 oz. (887.2 mL)
5" Sq. x 2 3/4" H (12.7 x 6.9 cm)
- SSQH73** 70 oz. (2.1 L)
7" Sq. x 3 1/4" H (17.8 x 8.3 cm)
- SSQH94** 146 oz. (4.3 L)
9 1/2" Sq. x 3 3/4" H (24.1 x 9.5 cm)
- SSQH117** 254 oz. (7.5 L)
12" Sq. x 4 1/2" H (30.5 x 11.4 cm)

Satin Finish

- SSQ53** 30 oz. (887.2 mL)
5" Sq. x 2 3/4" H (12.7 x 6.9 cm)
- SSQ73** 70 oz. (2.1 L)
7" Sq. x 3 1/4" H (17.8 x 8.3 cm)
- SSQ94** 146 oz. (4.3 L)
9 1/2" Sq. x 3 3/4" H (24.1 x 9.5 cm)
- SSQ117** 254 oz. (7.5 L)
12" Sq. x 4 1/2" H (30.5 x 11.4 cm)





DOUBLE-WALL BOWLS

Need to keep sauces, desserts and entrées cold? These stainless steel bowls get the job done and look fantastic in the process.

Hammered Double-Wall Bowls

- DWBH4** 17 oz. (502.8 mL)
4 ¾" Dia. x 2 ½" H (12.1 x 6.4 cm)
- DWBH6** 34 oz. (1 L)
6" Dia. x 3" H (15.2 x 7.6 cm)
- DWBH10** 156 oz. (4.6 L)
10" Dia. x 4" H (25.4 x 10.2 cm)
- DWBH12** 220 oz. (6.5 L)
12" Dia. x 5" H (30.5 x 12.7 cm)
- DWBH14** 338 oz. (10 L)
14" Dia. x 5" H (35.6 x 12.7 cm)
- DWBH16** 512 oz. (15.1 L)
16" Dia. x 5 ¾" H (40.6 x 14.6 cm)
- HMDWB14** 250 oz. (7.4 L)
14 ⅜" Dia. x 3 ¾" H (36.5 x 9.5 cm)
- HMDWB19** 657 oz. (19.4 L)
19" Dia. x 5 ½" H (48.3 x 14 cm)

Stackable Double-Wall Bowls

- SDWB40** 8 oz. (236.6 mL)
4" Dia. x 2" H (10.2 x 5.1 cm)
- SDWB45** 10 oz. (295.7 mL)
4 ½" Dia. x 2" H (11.4 x 5.1 cm)
- SDWB55** 16 oz. (473.2 mL)
5 ½" Dia. x 2" H (14 x 5.1 cm)



Satin Finish Double-Wall Bowls

- SW4** 17 oz. (502.8 mL)
4 3/4" Dia. x 2 1/2" H (12.1 x 6.4 cm)
- DWB6** 34 oz. (1 L)
6" Dia. x 3" H (15.2 x 7.6 cm)
- DWB10** 156 oz. (4.6 L)
10" Dia. x 4" H (25.4 x 10.2 cm)
- DWB12** 220 oz. (6.5 L)
12" Dia. x 5" H (30.5 x 12.7 cm)
- DWB14** 338 oz. (10 L)
14" Dia. x 5" H (35.6 x 12.7 cm)
- DWB16** 512 oz. (15.1 L)
16" Dia. x 5 3/4" H (40.6 x 14.6 cm)

Angled Double-Wall Bowls

- AB6** 23 oz. (680.2 mL)
6" Dia. x 3 1/2" H (15.2 x 8.9 cm)
- AB8** 54 oz. (1.6 L)
8" Dia. x 4 5/8" H (20.3 x 11.8 cm)
- AB12** 108 oz. (3.2 L)
10" Dia. x 5" H (25.4 x 12.7 cm)
- AB13** 216 oz. (6.4 L)
12" Dia. x 6" H (30.5 x 15.2 cm)
- AB14** 304 oz. (9 L)
13 7/8" Dia. x 6 1/2" H (35.3 x 16.5 cm)



UNIQUELY GEOMETRIC
BOTTOM STYLING

Good



Aluminum Seafood Trays

- SEA10** 36 oz., 10" Dia. x 2 1/4" H
(1.1 L, 25.4 x 5.7 cm)
- SEA12** 75 oz., 12" Dia. x 2 1/4" H
(2.2 L, 30.5 x 5.7 cm)
- SEA14** 120 oz., 13 7/8" Dia. x 2 1/4" H
(3.5 L, 35.2 x 5.7 cm)
- SEA16** 160 oz., 16" Dia. x 2 1/4" H
(4.7 L, 40.6 x 5.7 cm)
- SEA18** 200 oz., 17 3/4" Dia. x 2 1/4" H
(5.9 L, 45.1 x 5.7 cm)
- SEA20** 250 oz., 19 3/4" Dia. x 2 1/4" H
(7.4 L, 50.2 x 5.7 cm)

Better



Stainless Steel Seafood Trays

- SSEA10** 36 oz., 10" Dia. x 2 1/4" H
(1.1 L, 25.4 x 5.7 cm)
- SSEA12** 118 oz., 12 1/2" Dia. x 2 1/4" H
(3.5 L, 31.8 x 5.7 cm)
- SSEA14** 169 oz., 14 5/8" Dia. x 2 1/4" H
(5 L, 37.1 x 5.7 cm)
- SSEA16** 230 oz., 16 3/8" Dia. x 2 1/4" H
(6.8 L, 41.6 x 5.7 cm)
- SSEA18** 287 oz., 17 3/4" Dia. x 2 1/4" H
(8.5 L, 45.1 x 5.7 cm)

Even Better



Double-Wall Stainless Steel Seafood Trays

- DWSEA10** 56 oz., 10" Dia. x 2 1/4" H
(1.7 L, 25.4 x 5.7 cm)
- DWSEA12** 80 oz., 12" Dia. x 2 1/4" H
(2.4 L, 30.5 x 5.7 cm)
- DWSEA14** 112 oz., 14" Dia. x 2 1/4" H
(3.3 L, 35.6 x 5.7 cm)
- DWSEA16** 160 oz., 15 1/2" Dia. x 2 1/4" H
(4.7 L, 39.4 x 5.7 cm)
- DWSEA18** 204 oz., 17 5/8" Dia. x 2 1/4" H
(6 L, 45.4 x 5.7 cm)

Best



Double-Wall Hammered Stainless Steel Seafood Trays

- DWHSEA10** 56 oz., 10" Dia. x 2 1/4" H
(1.7 L, 25.4 x 5.7 cm)
- DWHSEA12** 80 oz., 12" Dia. x 2 1/4" H
(2.4 L, 30.5 x 5.7 cm)
- DWHSEA14** 112 oz., 14" Dia. x 2 1/4" H
(3.3 L, 35.6 x 5.7 cm)
- DWHSEA16** 160 oz., 15 1/2" Dia. x 2 1/4" H
(4.7 L, 39.4 x 5.7 cm)
- DWHSEA18** 204 oz., 17 5/8" Dia. x 2 1/4" H
(6 L, 45.4 x 5.7 cm)



USE SLIP-STOP SLEEVES (PG. 255)
TO KEEP TRAYS IN PLACE

SSEA12 and SSEA16 trays
shown with SDRCK



DWHSEA12 and DWHSEA18
shown with SDRCK seafood
display rack

Single Wall



Double Wall



Copper Hammered Aluminum Seafood Trays

Single Wall

ASEAC12 80 oz., 12" Dia. x 2" H
(2.4 L, 30.5 x 5.1 cm)

ASEAC14 128 oz., 14" Dia. x 2 1/2" H
(3.8 L, 35.6 x 6.4 cm)

Double Wall

ADSEAC12 80 oz., 12" Dia. x 2 1/4" H
(2.4 L, 30.5 x 5.7 cm)

ADSEAC14 128 oz., 14" Dia. x 2 1/2" H
(3.8 L, 35.6 x 6.4 cm)



Silver Hammered Aluminum Seafood Trays

Single Wall

ASEAS12 80 oz., 12" Dia. x 2" H
(2.4 L, 30.5 x 5.1 cm)

ASEAS14 128 oz., 14" Dia. x 2 1/2" H
(3.8 L, 35.6 x 6.4 cm)

Double Wall

ADSEAS12 80 oz., 12" Dia. x 2 1/4" H
(2.4 L, 30.5 x 5.7 cm)

ADSEAS14 128 oz., 14" Dia. x 2 1/2" H
(3.8 L, 35.6 x 6.4 cm)



Black Hammered Aluminum Seafood Trays

Single Wall

ASEAB12 80 oz., 12" Dia. x 2" H
(2.4 L, 30.5 x 5.1 cm)

ASEAB14 128 oz., 14" Dia. x 2 1/2" H
(3.8 L, 35.6 x 6.4 cm)

Double Wall

ADSEAB12 80 oz., 12" Dia. x 2 1/4" H
(2.4 L, 30.5 x 5.7 cm)

ADSEAB14 128 oz., 14" Dia. x 2 1/2" H
(3.8 L, 35.6 x 6.4 cm)



Gold Hammered Aluminum Seafood Trays

Single Wall

ASEAG12 80 oz., 12" Dia. x 2" H
(2.4 L, 30.5 x 5.1 cm)

ASEAG14 128 oz., 14" Dia. x 2 1/2" H
(3.8 L, 35.6 x 6.4 cm)

Double Wall

ADSEAG12 80 oz., 12" Dia. x 2 1/4" H
(2.4 L, 30.5 x 5.7 cm)

ADSEAG14 128 oz., 14" Dia. x 2 1/2" H
(3.8 L, 35.6 x 6.4 cm)



ADSEAC12

ADSEAC14

Shown with SDRCK seafood display rack and MBI sauce cup



SDRCK4

SDRCK



SSUS1

Seafood Display Racks

SDRCK4 Small
7 1/2" Top Dia. x 9 5/8" Bottom Dia. x 4" H
(19.1 x 24.4 x 10.2 cm)

SDRCK Large
7 1/2" Top Dia. x 9 5/8" Bottom Dia. x 7 3/8" H
(19.1 x 24.4 x 18.7 cm)

The Contempo™ Swirl Stand

SSUS1 Stainless Steel
7" Top Dia. x 9" Bottom Dia. x 7" H
(17.8 x 22.9 x 17.8 cm)



LWUS779 shown with SQND9 bowl

LWUS899 shown with HMRD12 bowl

LWUS1269

LWUS1041 shown with GBB20 bowl

LWUS738 shown with HMRST1801 tray

LWUS536 shown with CER5 bowl

CONTEMPO™ RISERS

The contemporary swirls of these risers are sure to elevate your cuisine in more ways than one. Wire is 3/8" thick. Black wrought iron risers sold in sets of six or sold separately. Stainless steel risers sold only in sets of six.

Wrought Iron Individual Risers

- LWUS536** 5" Top Dia. x 6 1/2" Bottom Dia. x 2 7/8" H (12.7 x 16.5 x 7.3 cm) Fits CER5 or MEL5
- LWUS738** 7" Top Dia. x 8 1/2" Bottom Dia. x 2 7/8" H (17.8 x 21.6 x 7.3 cm) Fits CER5, MEL5, CER7 or MEL7
- LWUS1041** 10" Top Dia. x 11 1/2" Bottom Dia. x 4" H (25.4 x 29.2 x 10.2 cm) Fits CER9 or MEL9
- LWUS899** 7 1/8" Top Dia. x 9 1/2" Bottom Dia. x 9" H (18.1 x 24.1 x 22.9 cm) Fits CER5, MEL5, CER7 or MEL7
- LWUS779** 7 1/8" Top Dia. x 9 1/4" Bottom Dia. x 7" H (18.1 x 23.5 x 17.8 cm) Fits CER5, MEL5, CER7 or MEL7
- LWUS1269** 12" Top Dia. x 14 1/2" Bottom Dia. x 5" H (30.5 x 36.8 x 12.7 cm) Fits CER9 or MEL9

Wrought Iron Riser Set

LWUS6 Set of 6

Stainless Steel Riser Set

SSUS6 Set of 6



SSUS6

Square and Rectangular Stands

Black

- DRCKB7** Square
7" Sq. Top x 9" Sq. Bottom x 7" H (17.8 x 22.9 x 17.8 cm)
- DRCKB6** Rectangle
9" L x 6" W Top x 11" L x 8" W Bottom x 7" H (22.9 x 15.2 x 27.9 x 20.3 x 17.8 cm)

Silver

- DRCKC7** Square
7" Sq. Top x 9" Sq. Bottom x 7" H (17.8 x 22.9 x 17.8 cm)
- DRCKC6** Rectangle
9" L x 6" W Top x 11" L x 8" W Bottom x 7" H (22.9 x 15.2 x 27.9 x 20.3 x 17.8 cm)



DRCKB7

DRCKB6 shown with FSLT14 faux slate platter and HMMJ4 mini apothecary jar



DRCKC7

DRCKC6 shown with 2212 wood peel, MGLCS mini glass shakers and caddy



Black Rubberized Stands  

Tired of tracking down rubber stoppers to keep your bowls and trays in place? These stands ingeniously have the rubber built-in. Plus, each of these contemporary wire-frame designs are reversible.

Round

- RSRB4** Small
7 1/2" Dia. Top x 9 5/8" Bottom Dia. x 4" H
(19.1 x 24.4 x 10.2 cm)
- RSRB** Medium
7 1/2" Dia. Top x 9 5/8" Bottom Dia. x 7 3/8" H
(19.1 x 24.4 x 18.7 cm)
- RSR10** Large
8 3/8" Dia. Top x 9 7/8" Bottom Dia. x 11 1/4" H
(21.3 x 25.1 x 29.8 cm)

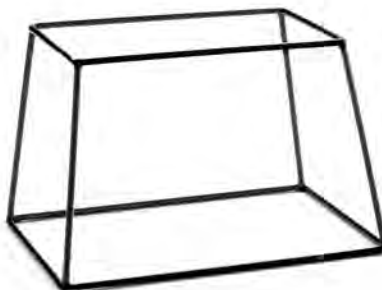

RSRB7

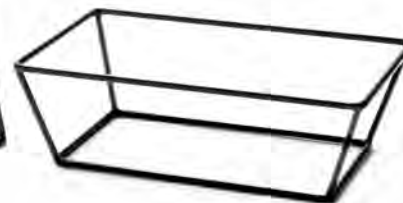

RSRB3

Rectangular

- RSRB3** Small
9" L x 6" W Top x 11" L x 8" W Bottom x 3 1/2" H
(22.9 x 15.2 x 27.9 x 20.3 x 8.9 cm)
- RSRB7** Large
9" L x 6" W Top x 11" L x 8" W Bottom x 7" H
(22.9 x 15.2 x 27.9 x 20.3 x 17.8 cm)

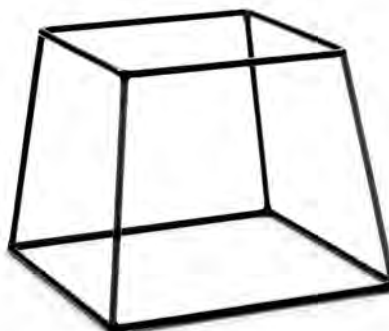

RSSB7

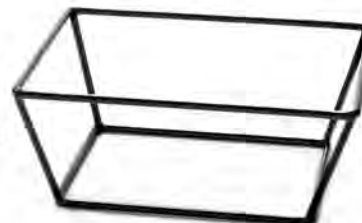

RSSB3

Square

- RSSB3** Small
7" Sq. Top x 9" Sq. Bottom x 3 1/2" H
(17.8 x 22.9 x 8.9 cm)
- RSSB7** Large
7" Sq. Top x 9" Sq. Bottom x 7" H
(17.8 x 22.9 x 17.8 cm)

AS20 shown with
MEL23 platter

AS20 shown with
MEL12 platter

AS20 shown with
MEL19 platter and
RGJ4 jars

Shown with HAMSC4, BS31, B31, BH31 sauce cups and CKNF7 cheese knife

LENGTH, WIDTH AND HEIGHT ARE FULLY ADJUSTABLE



Stainless Steel Adjustable Riser

A versatile addition to any buffet setup, this stainless steel stand can fit just about any rectangular platter. Its length, width and height can all be adjusted, making it our most adaptable riser to date.

AS20 12 1/4" L x 7 1/8" W x 2 7/8" H
(31.1 x 18.1 x 7.3 cm)
Expands up to 21" L x 11 1/2" x 4 1/8" H
(53.3 x 29.2 x 10.5 cm)

Three-Tier Chrome Arch Stands

An innovative step ladder design makes these stands collapsible when not in use. Check out amnow.com to see which of our products provide a perfect fit.

TASSM 17 1/2" L x 6" W x 11 1/4" H
(44.5 x 15.2 x 28.6 cm)

TASMED 25 1/4" L x 10 1/2" W x 13 3/4" H
(64.1 x 26.7 x 34.9 cm)

TASLG 21" L x 15 1/4" W x 12 3/4" H
(53.3 x 38.7 x 32.4 cm)

TASMED shown with CRGSQ94,
TWBB94 and FSMEL94 bowls

TASLG shown with
MEL19 and BAM14
platters

TASSM shown with
GJ24 glass jars



IS14 shown with two CER23 platters and one CER21 platter



IS13 shown with three BNBB13202 baskets

IS12 shown with two MEL21 platters

IRONWORKS™ Wrought Iron Stands

Available in two- and three-tier designs, these elegant wrought iron stands hold a wide range of trays, bowls, platters and baskets. Refer to amnow.com for suggestions on the most effective product combinations. Assembly required.

Rectangular Stands

- IS14** Three-Tier Stand
24" L x 15 1/4" W x 25 1/2" H
(61 x 38.7 x 64.8 cm)
- IS12*** Two-Tier Stand
23 3/8" L x 12 7/8" W x 23 1/2" H
(59.4 x 32.7 x 59.7 cm)
- IS13*** Three-Tier Stand
24 1/2" L x 12 3/16" W x 32 3/8" H
(62.2 x 31.9 x 82.2 cm)

*Indicates oversize package for UPS

Two-Tier Ironworks Stand

- TLSP1219** 12" H x 19" W
(30.5 x 48.3 cm)

Slip-Stop Sleeves

Barely noticeable black plastic sleeves keep plates and stand in place.

- 3SSS** 3-Pack, 4" L x 1/4" ID x 1/8" Thick
(10.2 x 0.6 x 0.1 cm)
- 4SSS** 4-Pack, 4 1/8" L x 1/4" ID x 1/8" Thick
(10.5 x 0.6 x 0.1 cm)
(not shown)



TLSP1219

Shown with GBB20 and GBB15 glacier bowls



3SSS



TTREC3 shown with three MEL19 platters (see pg. 197)

Three-Tier Foldable Stands

Elevate your presentations with our three-tier risers.

Rectangular

TTREC3 Open Frame Foldable Stand
17 3/8" L x 7 1/2" W x 10" H
(44.1 x 19.1 x 25.4 cm)

 **TPREC3** Solid Frame Foldable Stand
17 3/8" L x 7 1/2" W x 10" H
(44.1 x 19 x 25.4 cm)

 **TTMEL3** (1) TTREC3 Open Frame Foldable Stand with
(3) MEL19 Melamine Platters

Round

TTRS3 Open Frame Foldable Stand
14 1/8" W x 17 3/8" H
(35.9 x 44.1 cm)

 **TTRSMEL7** (1) TTRS Open Frame Foldable Stand
with (3) MEL7 Melamine Bowls

Three-Tier Rectangular Stands

IS18 Open Frame Stand
20" L x 13 3/4" W x 12" H
(50.8 x 34.9 x 30.5 cm)

 **ISP18** Solid Frame Stand
20" L x 13 3/4" W x 12" H
(50.8 x 34.9 x 30.5 cm)



TPREC3

RECTANGULAR THREE-TIER STANDS ARE AVAILABLE IN ATTRACTIVE RETAIL PACKAGING



TPREC3



ISP18



ISP18



LEGS FOLD OUT

TTRS3 shown with three MEL7 bowls (see pg. 194)



ISP18 shown with three MEL19 platters



COMPLEMENTS THE BLACK TWILIGHT BUFFET COLLECTION

BTS2 shown with GJ24 square glass jars, MESABUSH13 coffee urn



NCB95

Two-Tiered Black Twilight Condiment Rack

Contemporary and sleek, this new jet-black condiment organizer is an elegant way to keep toppings, sauces or straws in order. Check out amnow.com for accessory fit options.

BTS2 12 3/4" L x 9" W x 6" H
(32.4 x 22.9 x 15.2 cm)

Black Twilight Napkin Holder

Conveniently and compactly display napkins, guest towels and more with this sleek black napkin holder. Versatile enough to fit most decors but complements with the Black Twilight Collection completely.

NCB95 9" L x 5" W x 4 1/2" H
(22.9 x 12.7 x 11.4 cm)

Shown with BLHT1 tongs and CP7CL coupe plates



BR15 shown with GJ40 square glass jars

BR126 shown with MWME19 platter

BR128

Black Twilight Multifunctional Risers

Whichever way you use them, these metal risers would be a stylish, uber-versatile addition to your buffet service roster. Check out amnow.com for accessory fit options.

BR126 12 1/8" L x 6 1/8" W x 2" H
(30.8 x 15.6 x 5.1 cm)

BR15 14 5/8" L x 5 1/8" W x 2" H
(37.1 x 13 x 5.1 cm)

BR128 12 1/8" L x 8 1/8" W x 2" H
(30.8 x 20.6 x 5.1 cm)

Black Twilight Angled Risers

These black iron risers are modernizing buffetware design at full tilt. The unique angled construction makes self-service easier and looks striking in the process.

ARB3 Set of 3
6 1/2" Sq. x 5 3/4" H
(16.5 x 14.6 cm)
8 1/2" Sq. x 5 3/4" H
(21.6 x 14.6 cm)
10" Sq. x 5 3/4" H
(25.4 x 14.6 cm)



BR15 shown with GJ40 square glass jars

BR128 shown with GJ24 square glass jars

BR126 shown with GJ8 square glass jars



ARB3 shown with MWMSQ7, MWMSQ9 and MWMSQ11 bowls



TTS2319 shown with
PORD39 porcelain
sauce cup



Stainless Steel Tier Stands

The most graceful afternoon teas and pastry parties warrant the most graceful stages. These two- and three-tier stands impress customers in any setting.

STS2 Two-Tier Stand
5 5/8" Dia. x 7 3/4" H
(14.3 x 19.7 cm)

STS3 Three-Tier Stand
8 1/2" Dia. x 11 3/4" H
(21.6 x 29.8 cm)

Ascent³ Three-Tier Stand

In hammered stainless steel, this three-tier stand is the ultimate in elegance.

TTS2319 23" Dia. x 19 3/4" H
(58.4 x 50.2 cm)

Curl Riser Sets

Choose from a satin or hammered finish to complete these uniquely contemporary stainless steel risers.

Satin Curl Riser Set

CRS3 Set of 3
8 1/4" L x 4" W x 2" H
(21 x 10.2 x 5.1 cm)
10 1/2" L x 5 1/4" W x 4" H
(26.7 x 13.3 x 10.2 cm)
12 1/2" L x 6" W x 6 1/2" H
(31.8 x 15.2 x 16.5 cm)

Hammered Curl Riser Set

CRH3 Set of 3
8 1/4" L x 4" W x 2" H
(21 x 10.2 x 5.1 cm)
10 1/2" L x 5 1/4" W x 4" H
(26.7 x 13.3 x 10.2 cm)
12 1/2" L x 6" W x 6 1/2" H
(31.8 x 15.2 x 16.5 cm)



CRH3 shown with
GBG19 bowl

Shown with DPN9WH
narrow rim plates
and GVHT1 tongs



Tiered Buffet Stands

Give your next buffet a huge wow factor with these stunning stands. In colors and shapes designed to impress, there's no better way to elevate bite-sized hors d'oeuvres and desserts to the level of luxury. Built-in plates are crafted from frosted glass.

Gold

SRG3 Oval, Three-Tier Stand
12" L x 7" W x 20 1/2" H
(30.5 x 17.8 x 52.1 cm)
6" and 7 1/4" Dia. Glass Plates
(15.2 and 18.4 cm)

SRG4 Round, Four-Tier Stand
21 1/8" L x 6 5/8" W x 21 3/4" H
(53.7 x 16.8 x 55.2 cm)
6" and 7" Dia. Glass Plates
(15.2 and 17.8 cm)

Silver

SRS3 Oval, Three-Tier Stand
12" L x 7" W x 20 1/2" H
(30.5 x 17.8 x 52.1 cm)
6" and 7 1/4" Dia. Glass Plates
(15.2 and 18.4 cm)

SRS4 Round, Four-Tier Stand
21 1/8" L x 6 5/8" W x 21 3/4" H
(53.7 x 16.8 x 55.2 cm)
6" and 7" Dia. Glass Plates
(15.2 and 17.8 cm)

Replacement Frosted Glass Plates

RG6 6" Dia. (15.2 cm)

RG7 7 1/4" Dia. (18.4 cm)

Shown with DPW6WH
wide rim plates and
WVAT1 tongs





RRG2



RSQG2

Geo Riser Sets

With a sleek satin finish and minimalist design, these shimmering gold and black risers are always en vogue. Available in square and round shapes.

Gold

RRG2 Round, Set of 3
 5" Dia. x 1 1/2" H (12.7 x 3.8 cm)
 7" Dia. x 3" H (17.8 x 7.6 cm)
 9" Dia. x 5" H (22.9 x 12.7 cm)

RSQG2 Square, Set of 3
 5" Sq. x 1 1/2" H (12.7 x 3.8 cm)
 7" Sq. x 3" H (17.8 x 7.6 cm)
 9" Sq. x 5" H (22.9 x 12.7 cm)

Black

RRB2 Round, Set of 3
 5" Dia. x 1 1/2" H (12.7 x 3.8 cm)
 7" Dia. x 3" H (17.8 x 7.6 cm)
 9" Dia. x 5" H (22.9 x 12.7 cm)

RSQB2 Square, Set of 3
 5" Sq. x 1 1/2" H (12.7 x 3.8 cm)
 7" Sq. x 3" H (17.8 x 7.6 cm)
 9" Sq. x 5" H (22.9 x 12.7 cm)



RSQB2 shown with MWR18 platter



RRB2



RSG3



RHG1

Gold Riser Sets

Our customers asked, and we answered. These gold risers are guaranteed crowd-pleasers. In your choice of satin or hammered gold.

Satin Finish Riser Set

- RSG3** Set of 3
 6" Sq. x 4" H (15.2 x 10.2 cm)
 7" Sq. x 6" H (17.8 x 15.2 cm)
 8" Sq. x 8" H (20.3 x 20.3 cm)

Hammered Riser Set

- RHG1** Set of 3
 6" Sq. x 4" H (15.2 x 10.2 cm)
 7" Sq. x 6" H (17.8 x 15.2 cm)
 8" Sq. x 8" H (20.3 x 20.3 cm)

Stainless Steel Riser Sets

Individually hammered with a ball-peen hammer or in brushed satin, each riser in these sets is unique. Designed to nest for efficient storage.

Satin Finish Riser Set

- RSS3** Set of 3
 6" Sq. x 4" H (15.2 x 10.2 cm)
 7" Sq. x 6" H (17.8 x 15.2 cm)
 8" Sq. x 8" H (20.3 x 20.3 cm)

Hammered Riser Set

- RSH1** Set of 3
 6" Sq. x 4" H (15.2 x 10.2 cm)
 7" Sq. x 6" H (17.8 x 15.2 cm)
 8" Sq. x 8" H (20.3 x 20.3 cm)

Double-Wall Stainless Steel Crates

No matter which style you choose, our stainless steel crates bring outside-the-box inspiration to any table. Pairs with our Ultra Chill Cold Cell for perfectly chilled treats (Pg. 168).

Hammered Solid Crates

- SBHS** 9 1/8" Sq. x 2 1/2" H
 (23.2 x 6.4 cm)
SBHL 17 1/4" L x 9" W x 2 1/2" H
 (43.8 x 22.9 x 6.4 cm)

Satin Finish Solid Crates

- SBS** 9 1/8" Sq. x 2 1/2" H
 (23.2 x 6.4 cm)
SBL 17 1/4" L x 9" W x 2 1/2" H
 (43.8 x 22.9 x 6.4 cm)



RSS3 shown with BG189 platter



RSH1 shown with MEL23 platter



SBHL

SBHS



SBL

SBS



HMPRR3

HMPRS3

SOLID-TOP, FOOD-SAFE DESIGN
ALLOWS YOU TO SERVE DIRECTLY
ON THE RISERS—NO PLATE NECESSARY



HMRSET shown with
BG1911 platter and SRCH4
card holder

Walnut
Arugula-
Fetahead

Hammered Stainless Steel Frame Riser Sets

These three-piece riser sets are a stylish way to elevate higher-end culinary creations.

Solid Frame

HMPRS3 Square, Set of 3
6 ¾" Sq. x 3" H (17.1 x 7.6 cm)
7 ¾" Sq. x 4" H (19.7 x 10.2 cm)
8 ¾" Sq. x 5" H (22.2 x 12.7 cm)

HMPRR3 Rectangle, Set of 3
12 ¾" L x 6" W x 3 ⅞" H
(32.4 x 15.2 x 7.9 cm)
13 ¾" L x 7 ⅞" W x 4 ⅞" H
(34.9 x 18.1 x 10.5 cm)
14 ½" L x 8 ¼" W x 5 ⅞" H
(36.8 x 21 x 13 cm)

Open Frame

HMRSET Rectangle, Set of 3
7 ½" L x 4 ⅞" W x 4 ¾" H
(19.1 x 11.7 x 12.1 cm)
9 ¼" L x 6" W x 6 ½" H
(23.5 x 15.2 x 16.5 cm)
11 ½" L x 7 ⅞" W x 7 ½" H
(29.2 x 20 x 19.1 cm)

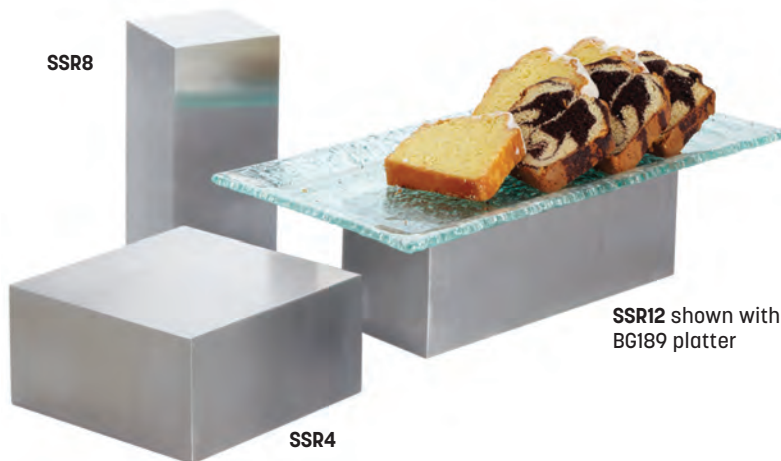

SSR8

SSR12 shown with
BG189 platter

SSR4

Cube Stainless Steel Risers

These brushed stainless steel risers create an upscale, contemporary look that complements even the sleekest settings.

SSR8 4" Sq. x 8" H (10.2 x 20.3 cm)
SSR12 4" Sq. x 12" H (10.2 x 30.5 cm)
SSR4 8" Sq. x 4" H (20.3 x 10.2 cm)



Wood Frame Riser Sets

Black laquered wood in an open or solid frame works well in any buffet or banquet setting.

Solid Frame

AWRSP Square, Set of 3
 6 3/4" Sq. x 3" H
 (17.1 x 7.6 cm)
 8 1/2" Sq. x 4 1/2" H
 (21.6 x 11.4 cm)
 10 1/4" Sq. x 6" H
 (26 x 15.2 cm)

AWRRP Rectangle, Set of 3
 13" L x 5 3/4" W x 3" H
 (33 x 14.6 x 7.6 cm)
 14 1/2" L x 7" W x 4 1/2" H
 (36.8 x 17.8 x 11.4 cm)
 16" L x 8" W x 6" H
 (40.6 x 20.3 x 15.2 cm)

AWRS Rectangle, Set of 3
 13 3/4" L x 7 3/8" W x 3 3/8" H
 (34.9 x 18.7 x 8.6 cm)
 17 1/2" L x 8 1/2" W x 6 1/2" H
 (44.5 x 21.6 x 16.5 cm)
 20 3/8" L x 11 1/4" W x 9 3/8" H
 (51.8 x 28.6 x 23.8 cm)

Open Frame

AWR10 Rectangle, Set of 3
 13 3/4" L x 7 3/8" W x 3 3/8" H
 (34.9 x 18.7 x 8.6 cm)
 17 1/2" L x 8 1/2" W x 6 1/2" H
 (44.5 x 21.6 x 16.5 cm)
 20 3/8" L x 11 1/4" W x 9 3/8" H
 (51.8 x 28.6 x 23.8 cm)



AWR10
 shown with
 CRGT23 and
 CRGT21
 platters

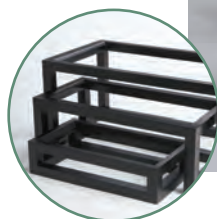

NESTS FOR EASY, ELEGANT STORAGE



RSB1 shown with CRGSQ53 and CRGSQ94 square bowls



RSM2 shown with AWMEL19 and AWMEL23 platters

Wood Riser Sets

These geometric pieces inspire all sorts of imaginative uses. Choose from black or mahogany and create a canvas for glass, melamine, ceramic or even metal dishes.

Black Riser Set

- RSB1** Set of 3
 5" Sq. (12.7 cm)
 7" Sq. (17.8 cm)
 9" Sq. (22.9 cm)

Mahogany Riser Set

- RSM2** Set of 3
 5" Sq. (12.7 cm)
 7" Sq. (17.8 cm)
 9" Sq. (22.9 cm)



THICK ACRYLIC WALLS STAND UP TO SUBSTANTIAL WEIGHT

Glacier Acrylic Risers

These acrylic risers look as though they've been chiseled from ice, creating an elegant stage for sushi, hors d'oeuvres and other light bites.

- AC555** 5" Sq. (12.7 cm)
AC777 7" Sq. (17.8 cm)



AC579 shown with GBB15 bowl



CRS1

Acrylic Frosted Cube Riser Set

These modern, versatile risers are a brilliant addition to all manner of tablescapes.

- AC579** Set of 3
 5" Sq. (12.7 cm)
 7" Sq. (17.8 cm)
 9" Sq. (22.9 cm)

Acrylic Riser Sets

Simple, subtle and versatile, these risers come in sets of four in black or clear acrylic.

Clear

- CRS1** Set of 4
 5" Sq. x 2" H (12.7 x 5.1 cm)
 6" Sq. x 4" H (15.3 x 10.2 cm)
 7" Sq. x 6" H (17.8 x 15.3 cm)
 8" Sq. x 8" H (20.3 x 20.3 cm)

Black

- BRS2** Set of 4
 5" Sq. x 2" H (12.7 x 5.1 cm)
 6" Sq. x 4" H (15.3 x 10.2 cm)
 7" Sq. x 6" H (17.8 x 15.3 cm)
 8" Sq. x 8" H (20.3 x 20.3 cm)

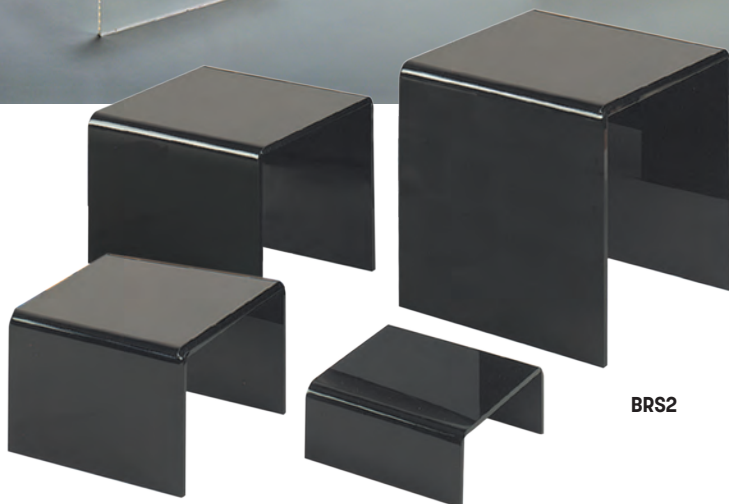

BRS2



RBRS3 shown with PSPL12 porcelain plate and OWBG9 serving board

Round Bamboo Riser Set

Form and function combine with this set. Use them as risers with bowls.

- RBRS3** Set of 3
 6" Dia. x 4" H
 (15.2 x 10.2 cm)
 9" Dia. x 5" H
 (22.9 x 12.7 cm)
 11" Dia. x 6" H
 (27.9 x 15.2 cm)

Bamboo Frame Riser Set

Minimalist form and natural wood color lend a whimsical, organic atmosphere to buffets. Can be used vertically or horizontally for different heights.

- BAMRSET** Set of 3
 7 1/2" L x 4 1/4" W x 4 3/4" H
 (19.1 x 10.8 x 12.1 cm)
 9 1/4" L x 6 1/4" W x 6" H
 (23.5 x 15.9 x 15.2 cm)
 11 1/4" L x 7 1/2" W x 7 7/8" H
 (28.6 x 19.1 x 20 cm)



BAMRSET shown with BD35 balti dishes on HMRT1019 and HMRT814 trays

Bamboo Riser Sets

Some of our most popular risers, these versatile pieces inspire warmth in any setting.

Natural Bamboo Riser Set

- BAMRN1** Set of 3
 5" Sq. x 2 1/2" H
 (12.7 x 6.4 cm)
 7" Sq. x 4 3/4" H
 (17.8 x 12.1 cm)
 9" Sq. x 6 3/8" H
 (22.9 x 16.2 cm)

Dark Bamboo Riser Set

- BAMRD2** Set of 3
 5" Sq. x 2 1/2" H
 (12.7 x 6.4 cm)
 7" Sq. x 4 3/4" H
 (17.8 x 12.1 cm)
 9" Sq. x 6 3/8" H
 (22.9 x 16.2 cm)



BAMRN1 shown with CER9 and SQB88 bowls



BAMRD2 shown with BG159 and BG189 platters



WOOD CRATES AND CADDIES

In multiple sizes and finishes, our line of wood crates and caddies works hard in any setting. Smaller sizes are a tasteful way to hold condiments, napkins or flatware, while larger crates are sized to fit with polycarbonate and insulated inserts. Best of all, every piece in this line can be flipped over and used as an imaginative riser.

Bamboo Wood Crates and Caddies

Crates

- WTBA6** 1/6-Size
6 1/4" L x 5 3/4" W x 5 3/4" H
(15.9 x 14.6 x 14.6 cm)
- WTBA12** 1/3-Size
12 1/4" L x 6 1/4" W x 6" H
(31.1 x 15.9 x 15.2 cm)
- WTBA10** Half-Size
10 1/4" L x 12 1/2" W x 8" H
(26 x 31.8 x 20.3 cm)
- WTBA20** Full-Size
20 1/2" L x 12 1/2" W x 8" H
(52.1 x 31.8 x 20.3 cm)

Beverage Inserts

- IBT65** 1/6-Size Insulated Insert for WTBA6
- IBT126** 1/3-Size Insulated Insert for WTBA12
- IBT200** Full-Size Polycarbonate Insert for WTBA20

Caddies

- WCBA4** 3 7/8" Sq. x 4 3/4" H
(9.8 x 12.1 cm)
- WCBA7** 7 1/2" L x 6 1/4" W x 4 3/4" H
(19.1 x 15.9 x 12.1 cm)



Shown with **TASSM** stand, **BEE316** shaker and **TIMI** waste bin



WARNING: This product can expose you to chemicals including Bisphenol A (BPA), which is known to the State of California to cause birth defects or other reproductive harm. For more information, go to www.P65warnings.ca.gov. Warning applies to State of California only.



Vintage Wood Crates and Caddies

Crates

- WTV6** 1/6-Size
6 1/4" L x 5 3/4" W x 5 3/4" H
(15.9 x 14.6 x 14.6 cm)
- WTV12** 1/3-Size
12 1/4" L x 6 1/4" W x 6" H
(31.1 x 15.9 x 15.2 cm)
- WTV10** Half-Size
10 1/4" L x 12 1/2" W x 8" H
(26 x 31.8 x 20.3 cm)
- WTV20** Full-Size
20 1/2" L x 12 1/2" W x 8" H
(52.1 x 31.8 x 20.3 cm)

Beverage Inserts

- IBT65** 1/6-Size Insulated Insert for WTV6
- IBT126** 1/3-Size Insulated Insert for WTV12
- IBT200** Full-Size Polycarbonate Insert for WTV20

Caddies

- WCV4** 3 7/8" Sq. x 4 3/4" H
(9.8 x 12.1 cm)
- WCV7** 7 1/2" L x 6 1/4" W x 4 3/4" H
(19.1 x 15.9 x 12.1 cm)



WARNING: This product can expose you to chemicals including Bisphenol A (BPA), which is known to the State of California to cause birth defects or other reproductive harm. For more information, go to www.P65warnings.ca.gov. Warning applies to State of California only.



AN EASY WAY TO
ELEVATE DINING HALL
PRESENTATION

WTBL20

WTBL6 shown with
IBT65 insulated insert

WTBL10

Black Wood Crates and Caddies

Crates

- WTBL6** 1/6-Size
6 1/4" L x 5 3/4" W x 5 3/4" H
(15.9 x 14.6 x 14.6 cm)
- WTBL12** 1/3-Size
12 1/4" L x 6 1/4" W x 6" H
(31.1 x 15.9 x 15.2 cm)
- WTBL10** Half-Size
10 1/4" L x 12 1/2" W x 8" H
(26 x 31.8 x 20.3 cm)
- WTBL20** Full-Size
20 1/2" L x 12 1/2" W x 8" H
(52.1 x 31.8 x 20.3 cm)

Beverage Inserts

- IBT65** 1/6-Size Insulated
Insert for WTBL6
- IBT126** 1/3-Size Insulated
Insert for WTBL12
- IBT200** Full-Size Polycarbonate
Insert for WTBL20

Caddies

- WCBL4** 3 7/8" Sq. x 4 3/4" H
(9.8 x 12.1 cm)
- WCBL7** 7 1/2" L x 6 1/4" W x 4 3/4" H
(19.1 x 15.9 x 12.1 cm)



WCBL7

WCBL4



WARNING: This product can expose you to chemicals including Bisphenol A (BPA), which is known to the State of California to cause birth defects or other reproductive harm. For more information, go to www.P65warnings.ca.gov. Warning applies to State of California only.



ATHC9

ATHC14

ATHC10

ATHC16 shown with the ACS cocktail shaker, WC40 water carafe, ACJ jigger, ACT Moscow mule mug and BB2 glass bitters bottle



ATHG9

ATHG14

ATHG10

ATHG16

Hammered Aluminum Beverage Tubs and Trays

Add a bit of charm to any occasion—from your next brunch buffet to a private table service for two. Available in multiple sizes, our Hammered Aluminum Beverage Tubs and Trays come in beautiful finishes for a striking look wherever they're placed.

Copper

- ATHC16** Tray, 16" Dia. x 2 ¾" H
(40.6 x 6.9 cm)
- ATHC9** Tub, 7 ¾ qt. (7.3 L)
12 ¼" L x 9" W x 8 ¾" H
(31.1 x 22.8 x 22.2 cm)
- ATHC10** Tub, 10 qt. (9.4 L)
15" L x 10 ¾" W x 7 ¼" H
(38.1 x 27.3 x 18.4 cm)
- ATHC14** Tub, 16 ¼ qt. (15.3 L)
19" L x 14" W x 8 ¼" H
(48.2 x 35.5 x 20.9 cm)

Gold

- ATHG16** Tray, 16" Dia. x 2 ¾" H
(40.6 x 6.9 cm)
- ATHG9** Tub, 7 ¾ qt. (7.3 L)
12 ¼" L x 9" W x 8 ¾" H
(31.1 x 22.8 x 22.2 cm)
- ATHG10** Tub, 10 qt. (9.4 L)
15" L x 10 ¾" W x 7 ¼" H
(38.1 x 27.3 x 18.4 cm)
- ATHG14** Tub, 16 ¼ qt. (15.3 L)
19" L x 14" W x 8 ¼" H
(48.2 x 35.5 x 20.9 cm)

Silver

- ATHS16** Tray, 16" Dia. x 2 ¾" H
(40.6 x 6.9 cm)
- ATHS9** Tub, 7 ¾ qt. (7.3 L)
12 ¼" L x 9" W x 8 ¾" H
(31.1 x 22.8 x 22.2 cm)
- ATHS10** Tub, 10 qt. (9.4 L)
15" L x 10 ¾" W x 7 ¼" H
(38.1 x 27.3 x 18.4 cm)
- ATHS14** Tub, 16 ¼ qt. (15.3 L)
19" L x 14" W x 8 ¼" H
(48.2 x 35.5 x 20.9 cm)

Black

- ATHB16** Tray, 16" Dia. x 2 ¾" H
(40.6 x 6.9 cm)
- ATHB9** Tub, 7 ¾ qt. (7.3 L)
12 ¼" L x 9" W x 8 ¾" H
(31.1 x 22.8 x 22.2 cm)
- ATHB10** Tub, 10 qt. (9.4 L)
15" L x 10 ¾" W x 7 ¼" H
(38.1 x 27.3 x 18.4 cm)
- ATHB14** Tub, 16 ¼ qt. (15.3 L)
19" L x 14" W x 8 ¼" H
(48.2 x 35.5 x 20.9 cm)





BEVDG20 shown with IBT200 liner

BEVDG129 shown with IBT125 liner

TUBS CAN BE FITTED WITH INSULATED AND POLYCARBONATE INSERTS

BEVDG6

BEVDG126 shown with IBT126 liner



BEVG129

BEVG20

BEVG6

BEVG126

Galvanized Beverage Tubs

In your choice of two galvanized colors, our new beverage tubs are useful wherever thirst needs to be quenched en masse. These tubs have a tapered design for easy storage.

Onyx

- BEVDG6** 1/6-Size, 6" L x 6 1/4" W x 5 3/4" H (15.2 x 15.9 x 14.6 cm)
- BEVDG126** 1/3-Size, 12 1/4" L x 6" W x 5 3/4" H (31.1 x 15.2 x 14.6 cm)
- BEVDG129** Half-Size, 12 1/2" L x 9 7/8" W x 7 7/8" H (31.8 x 25.1 x 20 cm)
- BEVDG20** Full-Size, 20 1/2" L x 12" W x 8" H (52.1 x 30.5 x 20.3 cm)

Silver

- BEVG6** 1/6-Size, 6" L x 6 1/4" W x 5 3/4" H (15.2 x 15.9 x 14.6 cm)
- BEVG126** 1/3-Size, 12 1/4" L x 6" W x 5 3/4" H (31.1 x 15.2 x 14.6 cm)
- BEVG129** Half-Size, 12 1/2" L x 9 7/8" W x 7 7/8" H (31.8 x 25.1 x 20 cm)
- BEVG20** Full-Size, 20 1/2" L x 12" W x 8" H (52.1 x 30.5 x 20.3 cm)

Beverage Inserts

- IBT65** 1/6-Size Insulated Insert
- IBT126** 1/3-Size Insulated Insert
- IBT125** Half-Size Polycarbonate Insert
- IBT200** Full-Size Polycarbonate Insert



WARNING: This product can expose you to chemicals including Bisphenol A (BPA), which is known to the State of California to cause birth defects or other reproductive harm. For more information, go to www.P65warnings.ca.gov. Warning applies to State of California only.



BEV820 shown
with IBT200 liner

BEVB556 shown
with IBT65 liner

BEVB6612 shown
with IBT126 liner



BEV1220

BEVC1266 shown
with IBT126 liner

BEVC655 shown
with IBT65 liner

Rectangular Hammered Tubs

Perfect for cafeterias, parties and buffets, these stylishly retro hammered tubs can be fitted with insulated and polycarbonate inserts.

Black

BEVB556 1/6-Size, 6 1/4" L x 5 3/4" W x 5 3/4" H
(15.9 x 14.6 x 14.6 cm)

BEVB6612 1/3-Size, 12 1/4" L x 6 1/4" W x 6" H
(31.1 x 15.9 x 15.2 cm)

BEV820 Full-Size, 20 1/2" L x 12 1/2" W x 8" H
(52 x 31.8 x 20.3 cm)

Copper

BEVC655 1/6-Size, 6 1/4" L x 5 3/4" W x 5 3/4" H
(15.9 x 14.6 x 14.6 cm)

BEVC1266 1/3-Size, 12 1/4" L x 6 1/4" W x 6" H
(31.1 x 15.9 x 15.2 cm)

BEV1220 Full-Size, 20 1/2" L x 12 1/2" W x 8" H
(52 x 31.8 x 20.3 cm)

Beverage Inserts

IBT65 1/6-Size Insulated Insert

IBT126 1/3-Size Insulated Insert

IBT200 Full-Size Polycarbonate Insert



WARNING: This product can expose you to chemicals including Bisphenol A (BPA), which is known to the State of California to cause birth defects or other reproductive harm. For more information, go to www.P65warnings.ca.gov. Warning applies to State of California only.



Black Wood Signs

Triangular wooden blocks feature sleek silver labels. Each measures 3" W x 1 3/4" H (7.6 x 4.4 cm).

- SIGNIT2** Iced Tea Sign
- SIGNSK9** Skim Milk Sign
- SIGND4** Decaf Sign
- SIGNC3** Coffee Sign
- SIGNHT1** Hot Tea Sign
- SIGNCR11** Cream Sign
- SIGNM8** Milk Sign
- SIGNW5** Hot Water Sign
- SIGNR6** Reserved Double-Sided Sign
- SIGN7** No Smoking Double-Sided Sign
- SIGNAS** This Area has been Sanitized Double-Sided Sign
- SIGNSD** Social Distancing in Effect Double-Sided Sign
- SIGNMR** Masks Required Double-Sided Sign
- SIGNSH** Please Sanitize your Hands Double-Sided Sign
- SIGNCO** Carry-Out Pickup Double-Sided Sign
- SIGNNS** Not in Service Double-Sided Sign

Laser Cut Signs

Silver

- SSD5** Decaf Sign
5" L x 3/4" W x 1 1/2" H
(12.7 x 1.9 x 3.8 cm)
- SSR5** Reserved Sign
5" L x 3/4" W x 1 1/2" H
(12.7 x 1.9 x 3.8 cm)
- SSC5** Coffee Sign
5" L x 3/4" W x 1 1/2" H
(12.7 x 1.9 x 3.8 cm)
- SSHW5** Hot Water Sign
5" L x 3/4" W x 1 1/2" H
(12.7 x 1.9 x 3.8 cm)

Black

- SBD5** Decaf Sign
5" L x 3/4" W x 1 1/2" H
(12.7 x 1.9 x 3.8 cm)
- SBR5** Reserved Sign
5" L x 3/4" W x 1 1/2" H
(12.7 x 1.9 x 3.8 cm)
- SBC5** Coffee Sign
5" L x 3/4" W x 1 1/2" H
(12.7 x 1.9 x 3.8 cm)
- SBHW5** Hot Water Sign
5" L x 3/4" W x 1 1/2" H
(12.7 x 1.9 x 3.8 cm)

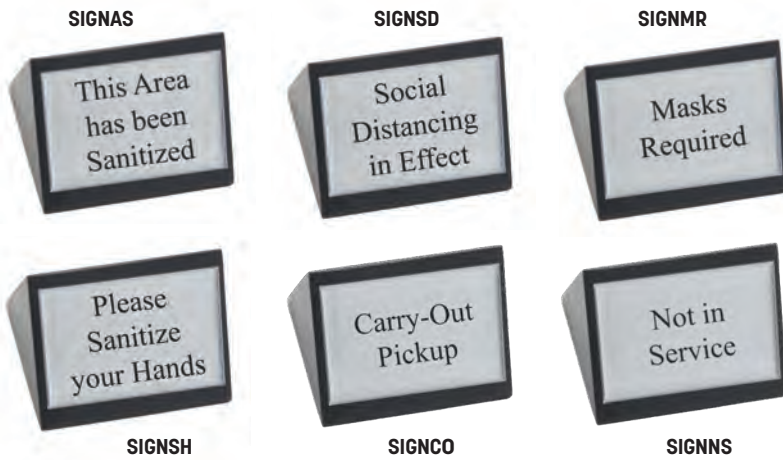

Stainless Steel Card Sign

This semicircular stainless steel menu card makes it easy to write on with a Securit Chalk Marker (pg. 296-297).

SMS1 5" L x 2 1/2" W x 2 5/8" H
(12.7 x 6.4 x 6.7 cm)



SMS1

Stainless Steel Three-Sided Signs

With three messages on every sign, this is an easy way to identify with minimal effort.

TTSVG3 Vegan/Vegetarian/Gluten-Free
4 3/4" L x 1 1/2" W x 1 3/8" H
(12.1 x 3.8 x 3.5 cm)

TTSB3 Coffee/Decaf/Hot Water
4 3/4" L x 1 1/2" W x 1 3/8" H
(12.1 x 3.8 x 3.5 cm)

TTMC3 Milk/Cream/Skim
4 3/4" L x 1 1/2" W x 1 3/8" H
(12.1 x 3.8 x 3.5 cm)



TTSVG3

Reserved Signs

Printed on both sides with classic, easily legible lettering.

2600 Plastic Standard Weight
6" L x 2" H (15.2 x 5.1 cm)

2601H Acrylic Heavy Weight
6" L x 2" H (15.2 x 5.1 cm)



2600



2601H



TTSB3



TTMC3



Deluxe Reservation Stands and Card Holders

CH Series made of all stainless steel. Weighted base measures 2 3/8" (6.7 cm). RS Series made of stainless steel with heavy weighted base. Mirror finish, 3 3/8" base (9.2 cm).

- CH4 4" H (10.2 cm)
- CH6 6" H (15.3 cm)
- CH8 8" H (20.3 cm)
- CH10 10" H (25.4 cm)
- RS12 12" H (30.5 cm)
- RS18 18" H (45.7 cm)

Low-Profile Menu and Card Holders

Choose from a range of styles and materials to match your dining room aesthetic.

- MH243** Nickel-Plated
2 1/4" Dia. x 2 1/2" H (5.7 x 6.4 cm)
- MH252** Stainless Steel
2 5/8" Dia. x 1 5/8" H (6.7 x 4.1 cm)
- BMH221** Black Metal
1 1/2" Dia. x 1 1/2" H (3.8 x 3.8 cm)
- MH220** Stainless Steel
1 1/2" Dia. x 1 1/2" H (3.8 x 3.8 cm)

Heavy Plastic Table Numbers

If speed is the name of your game, it's hard to beat easily legible black numbers on heavy white plastic. Each measures 4" (10.2 cm) square.

- 425 Nos. 1-25
- 450 Nos. 1-50
- 4100 Nos. 1-100
- 4150 Nos. 101-150
- 4200 Nos. 151-200
- 4250 Nos. 201-250
- 4300 Nos. 251-300

Mini Stainless Steel Number Tents

A stylish alternative to classic table numbers, these 1" (2.5 cm) square, double-sided, embossed tents are crafted from dishwasher-safe, heat-tolerant stainless steel.

- EM199 Nos. 1-99
- EM1200 Nos. 1-200
- EM200 Nos. 201-400
- EM400 Nos. 401-600



DOUBLE-SIDED FOR RAPID IDENTIFICATION



Laser Cut Number Stands

The stamped-out numbers in these stands deliver more pizzazz than your average table-markers. In your choice of black or silver.

Black

- NSB10** Nos. 1-10, 2" Dia. x 10" H (5.1 x 25.4 cm)
- NSB20** Nos. 11-20, 2" Dia. x 10" H (5.1 x 25.4 cm)
- NSB30** Nos. 21-30, 2" Dia. x 10" H (5.1 x 25.4 cm)
- NSB40** Nos. 31-40, 2" Dia. x 10" H (5.1 x 25.4 cm)
- NSB50** Nos. 41-50, 2" Dia. x 10" H (5.1 x 25.4 cm)

Silver

- NSC10** Nos. 1-10, 2" Dia. x 10" H (5.1 x 25.4 cm)
- NSC20** Nos. 11-20, 2" Dia. x 10" H (5.1 x 25.4 cm)
- NSC30** Nos. 21-30, 2" Dia. x 10" H (5.1 x 25.4 cm)
- NSC40** Nos. 31-40, 2" Dia. x 10" H (5.1 x 25.4 cm)
- NSC50** Nos. 41-50, 2" Dia. x 10" H (5.1 x 25.4 cm)



Stands shown from **NSB20**

Harp Weighted Number Stands

Black

- HPBL4** 2 ¼" Dia. x 4" H (5.7 x 10.2 cm)
- HPBL6** 2 ¼" Dia. x 6" H (5.7 x 15.2 cm)
- HPBL8** 2 ¼" Dia. x 8" H (5.7 x 20.3 cm)
- HPBL12** 2 ¼" Dia. x 12" H (5.7 x 30.5 cm)
- HPBL18** 2 ¼" Dia. x 18" H (5.7 x 45.7 cm)

Chrome

- HPCH4** 2 ¼" Dia. x 4" H (5.7 x 10.2 cm)
- HPCH6** 2 ¼" Dia. x 6" H (5.7 x 15.2 cm)
- HPCH8** 2 ¼" Dia. x 8" H (5.7 x 20.3 cm)
- HPCH12** 2 ¼" Dia. x 12" H (5.7 x 30.5 cm)
- HPCH18** 2 ¼" Dia. x 18" H (5.7 x 45.7 cm)



Stands shown from **NSC10**

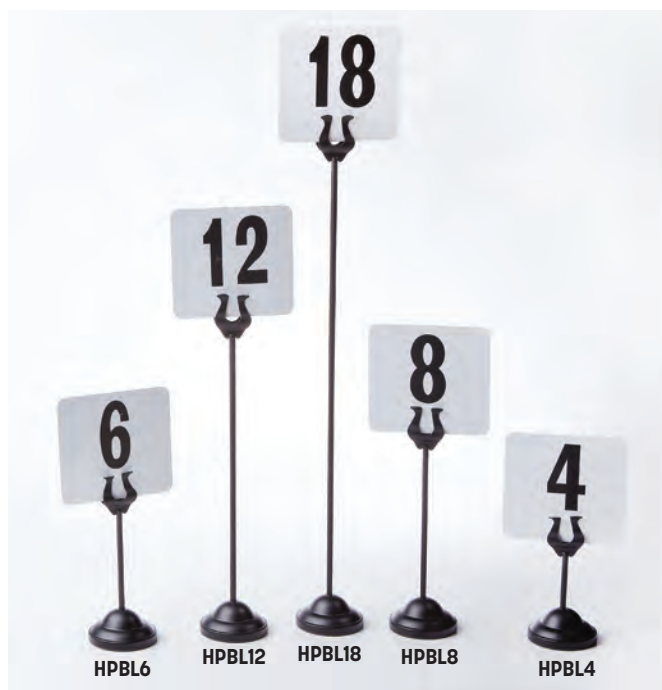

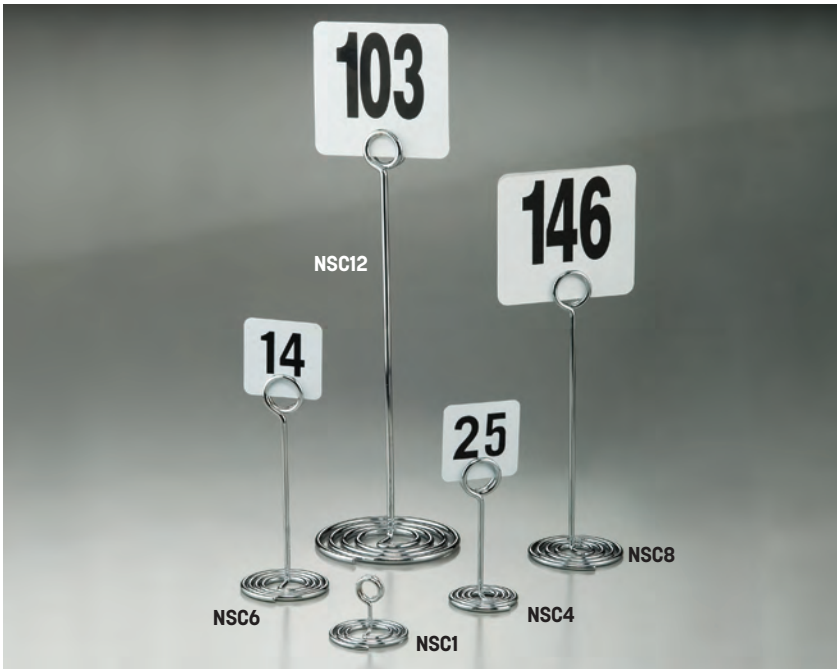

Spiral Number Holders

This playfully imaginative, spring-like design comes in chrome or black.

Chrome

- SNC1** 2 3/8" Dia. x 3" H (6 x 7.6 cm)
- MHSC6** 2 1/4" Dia. x 6" H (5.7 x 15.2 cm)

Black

- SNB2** 2 3/8" Dia. x 3" H (6 x 7.6 cm)
- MHSB7** 2 1/4" Dia. x 6" H (5.7 x 15.2 cm)

Swirl Base Number Stands

Chrome

- NSC1** 2" Dia. x 1 1/2" H (5.1 x 3.8 cm)
- NSC4** 2 1/2" Dia. x 4" H (6.4 x 10.2 cm)
- NSC6** 2 1/2" Dia. x 6" H (6.4 x 15.2 cm)
- NSC8** 3" Dia. x 8" H (7.6 x 20.3 cm)
- NSC12** 4" Dia. x 12" H (10.2 x 30.5 cm)

Black

- NSB1** 2" Dia. x 1 1/2" H (5.1 x 3.8 cm)
- NSB4** 2 1/2" Dia. x 4" H (6.4 x 10.2 cm)
- NSB6** 2 1/2" Dia. x 6" H (6.4 x 15.2 cm)
- NSB8** 3" Dia. x 8" H (7.6 x 20.3 cm)
- NSB12** 4" Dia. x 12" H (10.2 x 30.5 cm)

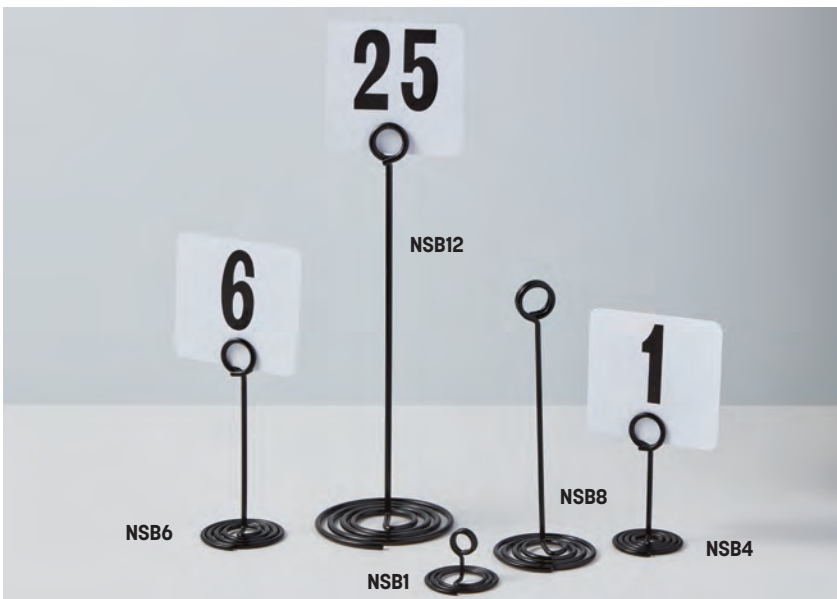

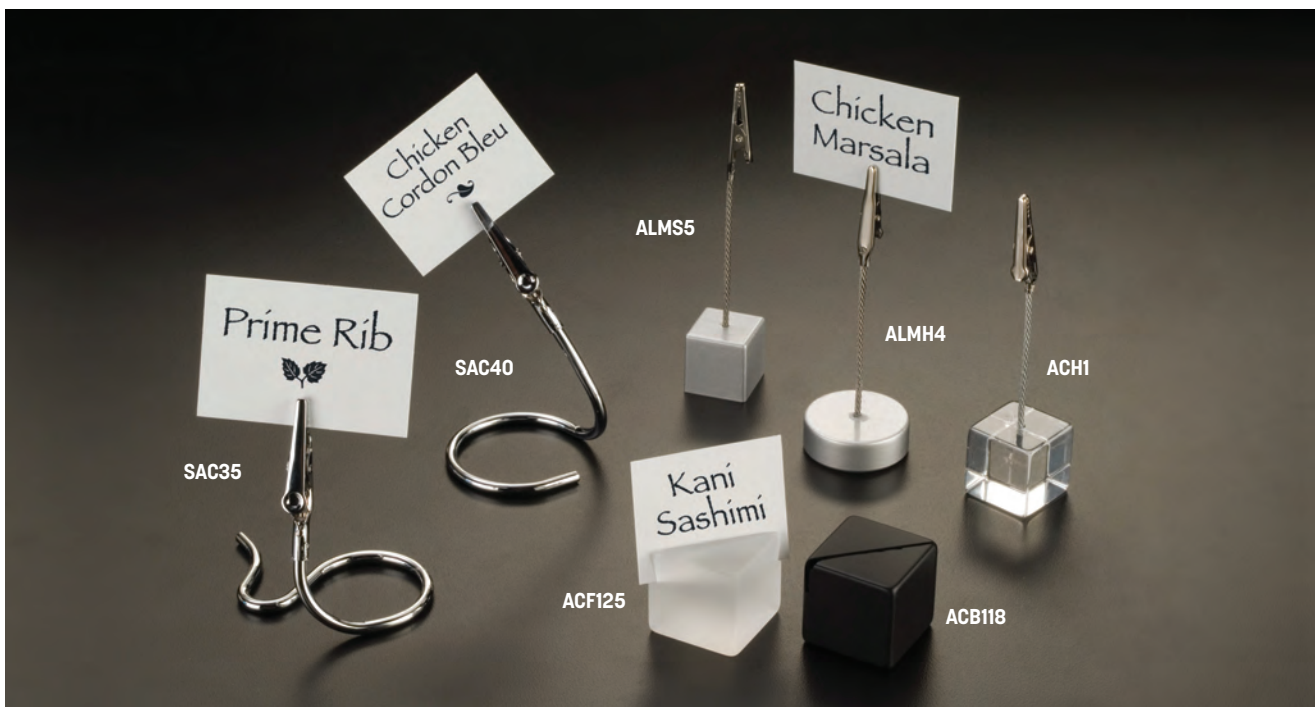

Card Holders

Choose from snappy alligator clips or sophisticated cubes to label buffets in a distinctive, contemporary way.

Swirly Alligator Clip Card Holders

SAC40 "C" Design, 4" H (10.2 cm)

SAC35 "S" Design, 3 ½" H (8.9 cm)

Aluminum Alligator Clip Card Holders

ALMH4 Round, 4 ¼" H (10.8 cm)

ALMS5 Square, 4 ¼" H (10.8 cm)

Acrylic Alligator Clip Card Holder

ACH1 Square, 4 ¼" H (10.8 cm)

Acrylic Cube Card Holders

ACF125 Frosted White
1 ½" Sq. (2.9 cm)

ACB118 Black
1 ½" Sq. (2.9 cm)

Double-Sided Flexible Sign Clip

Clip these flexible, gravity-defying markers on trays, platters or bowls.

CLIPIT2 5 ¼" L x ½" W
(13.3 x 1.3 cm)

CLIPIT6 6" L x ½" W
(15.2 x 1.3 cm)



CLIPIT2 shown with TAGA8WT and TAGA7WT mini chalk cards





Shown with TAGA8BL mini chalk cards



Shown with TAGA8BL mini chalk cards



BC1 shown with TAGA7WT mini chalk card

Hammered Aluminum Card Holders

Each aspect of these head-turning designs is purposeful. Small stature keeps table space open, while hammered aluminum is heavy enough to stay in place.

Black

- BLCHL2** Angled Cut Cylinder
1 1/4" L x 7/8" W x 7/8" H
(3.2 x 2.2 x 2.2 cm)
- BLCHL1** Cylinder
1 1/4" L x 7/8" W x 7/8" H
(3.2 x 2.2 x 2.2 cm)
- BLCHBC1** Half Moon
2 1/8" L x 3/4" W x 3/4" H
(5.4 x 1.9 x 1.9 cm)
- BLCHS1** Angled Cut Square
7/8" Sq. (2.2 cm)
- BLCHR1** Rectangular
1" L x 1 1/4" W x 1" H
(3.2 x 2.2 x 2.2 cm)
- BLCHD1** Round
7/8" Dia. x 3/4" H
(2.2 x 1.9 cm)

Silver

- HCHL2** Angled Cut Cylinder
1 1/4" L x 7/8" W x 7/8" H
(3.2 x 2.2 x 2.2 cm)
- HCHL1** Cylinder
1 1/4" L x 7/8" W x 7/8" H
(3.2 x 2.2 x 2.2 cm)
- HCHBC1** Half Moon
2 1/8" L x 3/4" W x 3/4" H
(5.4 x 1.9 x 1.9 cm)
- HCHS1** Angled Cut Square
7/8" Sq. (2.2 cm)
- HCHR1** Rectangular
1" L x 1 1/4" W x 1" H
(2.5 x 3.2 x 2.5 cm)
- HCHD1** Round
7/8" Dia. x 3/4" H
(2.2 x 1.9 cm)

Copper

- BHCHL2** Angled Cut Cylinder
1 1/4" L x 7/8" W x 7/8" H
(3.2 x 2.2 x 2.2 cm)
- BHCHL1** Cylinder
1 1/4" L x 7/8" W x 7/8" H
(3.2 x 2.2 x 2.2 cm)
- BHCHBC1** Half Moon
2 1/8" L x 3/4" W x 3/4" H
(5.4 x 1.9 x 1.9 cm)
- BHCHS1** Angled Cut Square
7/8" Sq. (2.2 cm)
- BHCHR1** Rectangular
1" L x 1 1/4" W x 1" H
(2.5 x 3.2 x 2.5 cm)
- BHCHD1** Round
7/8" Dia. x 3/4" H
(2.2 x 1.9 cm)

Cast Aluminum Card Holder

- BC1** Half Moon
2 1/8" L x 3/4" W x 3/4" H
(5.4 x 1.9 x 1.9 cm)

MCHW125 shown with TAGA6WT chalk card

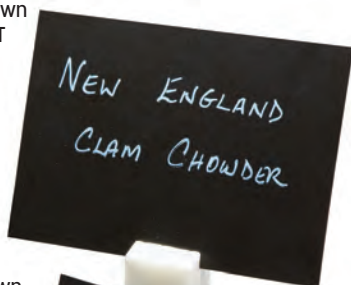

MCHB125 shown with TAGA8WT chalk card



SRCH125

SRCH4 shown with TAGA7WT mini chalk card

Marble Card Holders

Add a touch of elegance to any setting with black or white marble.

MCHB125 Black
1 1/4" Sq. x 1" H
(3.2 x 2.5 cm)

MCHW125 White
1 1/4" Sq. x 1" H
(3.2 x 2.5 cm)

Round Rod Card Holders

Brushed stainless steel and minimalistic design resonate elegance. Fit a variety of card sizes in the 1/4" (0.64 cm) slit.

SRCH125 1 1/4" L x 5/8" H
(3.2 x 1.6 cm)

SRCH4 4" L x 5/8" H
(10.2 x 1.6 cm)



SSCH4 and SSCH125 shown with TAGA7WT mini chalk card

PERFECT FIT FOR MINI CHALK CARDS (PG. 290)

Square Rod Card Holders

Simple and functional, these stainless steel pieces hold all manner of cards.

Silver

SSCH125 3/8" Sq. x 1 1/2" L
(1 x 3.2 cm)

SSCH4 3/8" Sq. x 4 1/8" L
(1 x 10.2 cm)

Black

BCH125 3/8" Sq. x 1 1/2" L
(1 x 3.2 cm)

BCH4 3/8" Sq. x 4 1/8" L
(1 x 10.2 cm)



BCH4

BCH125

Stainless Steel Card Holders

Clever design takes up minimal table space, while brushed stainless steel is effortlessly cool.

DXCH2 1 1/2" L x 1 3/4" W x 1 1/8" H
(3.8 x 4.4 x 2.9 cm)

DXCH1 2" L x 2" W x 3/4" H
(5.1 x 5.1 x 1.9 cm)

DXCH2



DXCH1



Stone Card Holders

As though they've been plucked from a riverbed, these card holders create a fun, organic effect.

CHBS Black
1 ¼" L x 1" W x ½" H
(3.2 x 2.5 x 1.3 cm)

CHGS Gray
1 ¼" L x 1" W x ½" H
(3.2 x 2.5 x 1.3 cm)

Acrylic Card Holders

As simple as it gets, this piece holds cards in all shapes and sizes.

TAGHDTR 2 ¾" L x 1 ½" W x ½" H
(6 x 3.9 x 1.3 cm)

Acrylic Card Holder Set

Fifty contemporary clear acrylic card holders in a convenient carrying case. **Sold in a set of 50.**

LK50 1 ¼" L x 1" W x ¼" H
(3.2 x 2.5 x 0.6 cm)



Shown with (2) MELPOT24 melamine terra cotta pots

TAGHDTR



LK50

Shown with TAGA8WT mini chalk card

INCLUDES CARRYING CASE THAT HOLDS ALL FIFTY CARD HOLDERS



Clothespin Card Holders

Perfect for rustic or backyard-inspired settings, clothespin holders are available in natural, black, red and white wood.

CPCHB	Black ½" L x 1½" W x ¾" H (1.3 x 3.8 x 8.3 cm)
CPCHR	Red ½" L x 1½" W x ¾" H (1.3 x 3.8 x 8.3 cm)
CPCHN	Natural ½" L x 1½" W x ¾" H (1.3 x 3.8 x 8.3 cm)
CPCHW	White ½" L x 1½" W x ¾" H (1.3 x 3.8 x 8.3 cm)



Bamboo Card Holders

Clean lines and contemporary styling draws customers' eyes to the cards.

BAMBL125	Black 1¼" L x 1⅛" W x ¾" H (3.2 x 2.9 x 1.9 cm)
BAMCH125	Natural 1¼" L x 1⅛" W x ¾" H (3.2 x 2.9 x 1.9 cm)
BAMBL4	Black 4" L x 1⅛" W x ¾" H (3.2 x 2.9 x 1.9 cm)
BAMCH4	Natural 4" L x 1⅛" W x ¾" H (3.2 x 2.9 x 1.9 cm)

Square Wood Card Holders

In olive wood or walnut, these cubes with rounded corners measure 1⅛" Sq. (2.9 cm).

SOCH	Olive Wood
SWCH	Walnut





CMCSW2

USE SECURIT MARKERS
(PG. 296-297) ON ANY
OF THESE SIGNS



CMP553

CMP520

CMP425

Geometric Ceramic Card Signs

Write, wipe, repeat. These ceramic signs are endlessly reusable and appropriate for all levels of formality.

- CMCSW2** Rectangle
5" L x 2 1/4" W x 2 1/2" H
(12.7 x 5.7 x 6.4 cm)
- CMP553** Rectangle
5 1/2" L x 3 1/2" H
(14 x 8.9 cm)
- CMP520** Oval
5" L x 2 3/8" H
(12.7 x 6 cm)
- CMP425** Rectangle
3 3/4" L x 2 1/2" H
(9.5 x 6.4 cm)

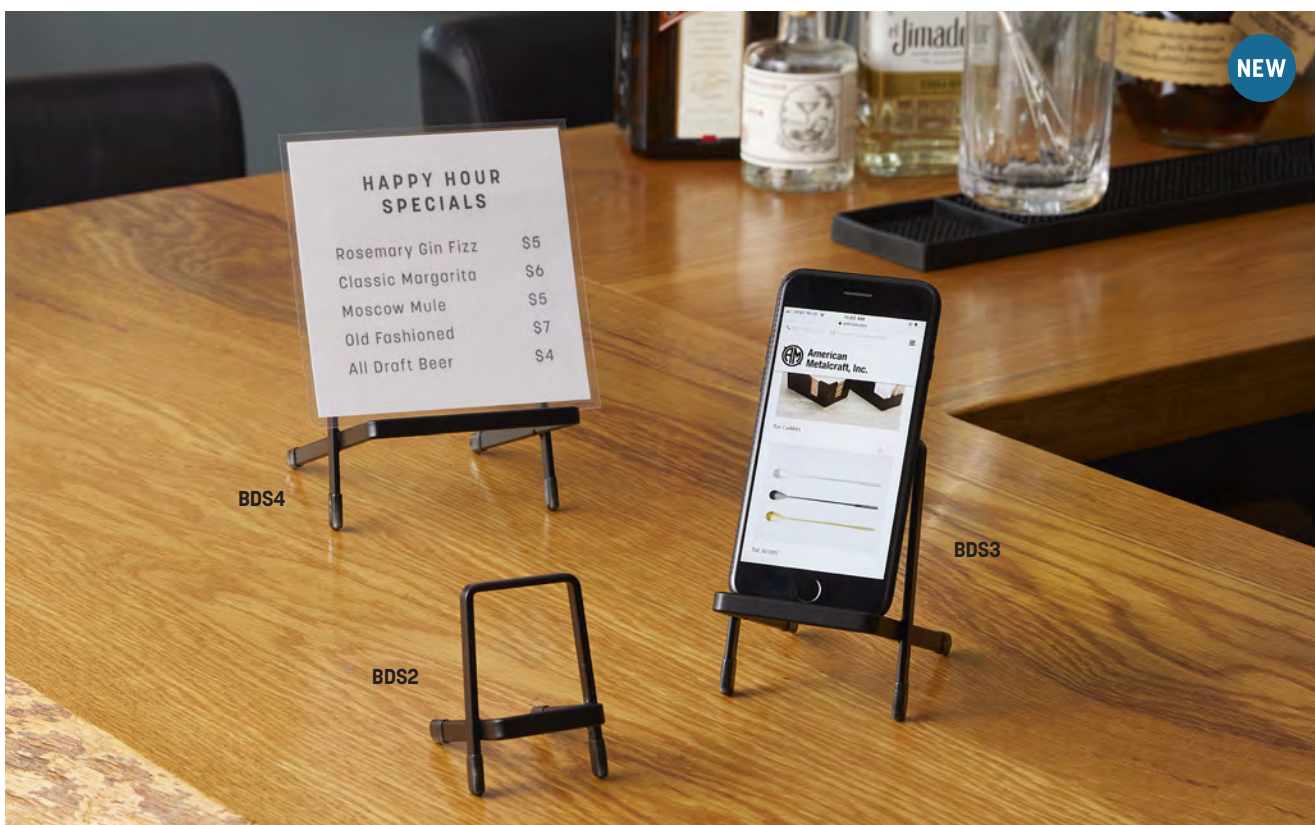

Black Display Stands NEW

Display promotional messages, QR menu codes, or provide a safe stand for cell phones with these versatile black display stands. Available in multiple sizes for individual needs.

BDS2 2" L x 3 3/8" W x 3 1/4" H
(5.1 x 8.6 x 8.3 cm)

BDS3 3" L x 5" W x 4 1/2" H
(7.6 x 12.7 x 11.4 cm)

BDS4 4 1/8" L x 6" W x 5 3/4" H
(10.5 x 15.2 x 14.6 cm)

Mini Silhouette Chalkboards NEW

Mix and match oval and rectangular styles, all featuring a 5" (12.7 cm) pick that's perfect for baked goods. Includes a white Securit® Chalk Marker. Sold in a pack of 5.

TAGBUBBLES5 3 1/8" L x 2 3/8" W x 7 1/8" H
(7.9 x 6 x 18.1 cm)

TAGRECTANGLES5 3 1/8" L x 2 1/8" W x 7 1/8" H
(7.9 x 5.4 x 18.1 cm)





Shown with LK50 card holders

TAGA7BL

TAGA8BL

TAGA6BL

NOW AVAILABLE IN DRY-ERASE-INSPIRED WHITE

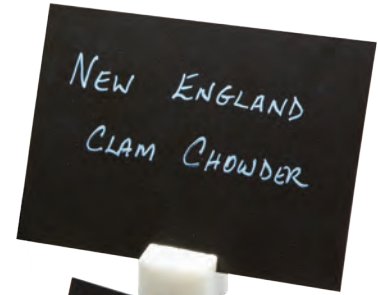

TAGA6WT shown with MCHW125 card holder



TAGA8WT shown with MCHB125 card holder

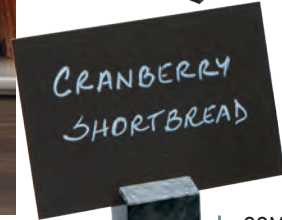

TAGA7WT shown with MCHB125 card holder

COMES WITH WHITE SECURIT MARKER THAT MAKES LABELING A CINCH



TAGHLDBL

PICK CAN BE USED WITH FOOD OR STAND ON ITS OWN

Mini Chalk Cards

These mini blackboards fit into holders, clips and number stands. Each pack comes with its own White Securit Chalk Marker, four mini chalk card picks and two acrylic mini chalk card holders. **Sold in a pack of 20.**

White

TAGA8BL 3" L x 2" H (7.6 x 5.1 cm)

TAGA7BL 4" L x 3" H (10.2 x 7.6 cm)

TAGA6BL 6" L x 4" H (15.2 x 10.2 cm)

Black

TAGA8WT 3" L x 2" H (7.6 x 5.1 cm)

TAGA7WT 4" L x 3" H (10.2 x 7.6 cm)

TAGA6WT 6" L x 4" H (15.2 x 10.2 cm)

Mini Chalk Card Pick

This tiny tag holder is hugely versatile. With a flexible pick, it can be used at multiple angles. **Sold in a pack of 20.**

TAGHLDBL 2" H (5.1 cm)

Bottle Displays 

WBWR3 Display 3 Bottles + 3 Chalkboards
16" W x 19" H (40.6 x 48.3 cm)

Securit Chalkboards 

PFW2736BL Double-Sided Window Chalkboard
with Suction Cups
10 7/8" L x 13 7/8" H (27.6 x 35.2 cm)

FBSQUARE Chalkboard with
Self-Adhesive Strips
(comes with White Chalk Marker)
11 7/8" L x 13 5/8" H (30.2 x 34.6 cm)

Bottleneck Chalkboard Tags

Includes six oval tags with leather cord. Chalk marker included. **Sold in a pack of 6.**

TAGBOTTLE 2" L x 3 1/4" W (5.1 x 8.3 cm)



WBWR3

PROMOTE A TRIO OF SPECIALS,
PAIRINGS OR TASTINGS AT A TIME



PFW2736BL

FBSQUARE



Securit
WALL CHALKBOARD
SILHOUETTE



TAGBOTTLE

CSWALL100



Peel 'n Stick Chalkboard Roll 

The peak of promotional versatility, this roll of black vinyl can be trimmed to size or even cut into imaginative shapes. Adhesive backing makes it easy to apply, remove and re-position.

CSWALL100 39 1/8" L x 17 3/4" H
(99.4 x 45.1 cm)

Wood Chalkboard Tray 

For impressively personalized and organized room service, this innovative, espresso-toned tray is the stuff of the hospitality industry's dreams.

RSTDB60 24" L x 16" W x 1 1/2" H
(61 x 40.6 x 3.8 cm)



Shown with GMB32 glass milk bottle, PSPL8 porcelain plate and RGJ6 glass jar

Universal Stainless Steel Signs 

Our contemporary take on classic signage gives six universal symbols a sleek, yet instantly recognizable reimagining. **Sold in a set of 6.**

SISSET 4" Dia. x 1/8" H
(10.2 x 0.3 cm)



SISSET

EASY TO HANG ON ANY SURFACE





TAGSBSWT

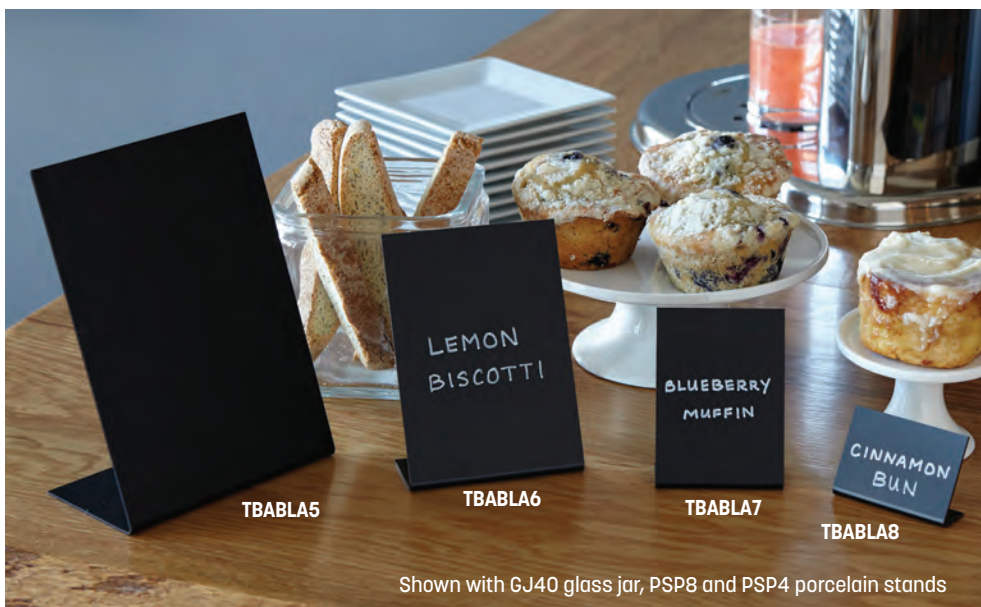

TBABLA5

TBABLA6

TBABLA7

TBABLA8

Shown with GJ40 glass jar, PSP8 and PSP4 porcelain stands

Mini Chalkboard Tent Sign

A tiny version of our Sandwich Board (pg. 304), this charming tent sign is a new customer favorite. Comes with a White Securit Chalk Marker. **Sold in a pack of 5.**

TAGSBSWT 2" L x 1" W x 3 3/8" H
(5.1 x 2.5 x 8.6 cm)

Tabletop Chalkboards

These stand-alone, one-piece boards are a modern way to elevate buffets, breakfast bars and display cases.

TBABLA8 2 7/8" L x 7/8" W x 2" H (7.3 x 2.2 x 5.1 cm)
Pack of 5

TBABLA7 2 7/8" L x 1 3/8" W x 4 1/8" H (7.3 x 3.5 x 10.5 cm)
Pack of 5

TBABLA6 4 1/8" L x 1 3/4" W x 5 7/8" H (10.5 x 4.4 x 14.9 cm)
Pack of 3

TBABLA5 5 7/8" L x 3" W x 8 1/4" H (14.9 x 7.6 x 21 cm)
Pack of 3

Mini Chalkboard Easels

These miniature easeled boards contribute to A+ presentation. Comes with White Securit Chalk Marker.

MNIBKR1 Plain, 6" W x 10" H
(15.2 x 25.4 cm)

MNIBLKR1 Black, 6" W x 10" H
(15.2 x 25.4 cm)

MNIMKR1 Mahogany, 6" W x 10" H
(15.2 x 25.4 cm)

Mini Tabletop Sandwich Board

This miniature board doubles as a great asset for your social media.

SBSBMNI Plain, 6" W x 9 3/4" H
(15.2 x 24.8 cm)



MNIBLKR1

MNIMKR1

MNIBKR1

SBSBMNI



Tabletop Boards

Create custom messages and designs with these double-sided boards in your choice of size and finish. Removable, reusable blackboard included. Markers sold separately on pg. 296-297.

Black

- ELEBLSM** 4" W x 6" H
(10.2 x 15.2 cm)
- ELEBLME** 6" W x 9" H
(15.2 x 22.9 cm)
- ELEBLLA** 9" W x 12" H
(22.9 x 30.5 cm)

Mahogany

- ELEMSM** 4" W x 6" H
(10.2 x 15.2 cm)
(not shown)
- ELEMME** 6" W x 9" H
(15.2 x 22.9 cm)
(not shown)
- ELEMLA** 9" W x 12" H
(22.9 x 30.5 cm)

Plain

- ELEBSM** 4" W x 6" H
(10.2 x 15.2 cm)
- ELEBME** 6" W x 9" H
(15.2 x 22.9 cm)
- ELEBLA** 9" W x 12" H
(22.9 x 30.5 cm)

Tabletop Board Accessories

Clear signage features slits to insert menus or promotions. Three sizes fit the three different sized tabletop boards.

Sold in a pack of 5.

- PVCSM** 4" W x 5 7/8" H
(10.2 x 14.9 cm)
- PVCME** 6" W x 8 3/8" H
(15.2 x 21.2 cm)
- PVCLA** 8 1/4" W x 11 3/4" H
(21 x 29.8 cm)



ELEBSM

ELEBME

ELEBLA



PVCLA shown with ELEBLA

PVCME shown with ELEBLME

PVCSM shown with ELEBSM

Securit®



Mini Tip



FROM LEFT TO RIGHT
 WHITE
 BLUE
 GREEN
 RED
 NEON YELLOW
 NEON PINK
 NEON ORANGE
 NEON PURPLE



SMA100WT



BLSMA100V4WH



BLSMA100V4CO



BLSMA100V4TR

Original Chalk Markers

Great signage takes a bit of artistry, but just using a better medium will bring out your most inspired menus and promotions. These chalk markers are resistant to smudging, fading and light rain. Plus, they can be used on any non-porous surfaces and easily cleaned off with a soapy wet cloth.

Mini Tip Markers

SMA100WT White Mini Tip Bulk Pack



BLSMA100V4WH White Mini Tip Blister 4-Pack



BLSMA100V4CO Assortment Mini Tip Blister 4-Pack (White, Blue, Green, Red)



BLSMA100V4TR Assortment Tropical Mini Tip Blister 4-Pack (Neon Purple, Neon Yellow, Neon Pink, Neon Orange)



Small Tip Markers

SMA510WT White Small Tip Bulk Pack



BLSMA510WT White Small Tip Blister 2-Pack



SMA510V4WT White Small Tip 4-Pack



SMA510V4 Assortment Small Tip 4-Pack (Green, Yellow, Blue, Red)



SMA510V8ET Earth Tone Assortment Small Tip 8-pack (Slate Gray, Forget-Me-Not, Moss Green, Buttercup, Golden Yarrow, Honeysuckle, Jubilee Cherry, Burnt Sienna)



Small Tip



FROM LEFT TO RIGHT:
 SLATE GREY
 WHITE
 BLUE
 GREEN
 GREEN
 BUTTERCUP
 RED
 GOLDEN YARROW
 HONEYSUCKLE
 YELLOW
 JUBILEE CHERRY
 BURNT SIENNA



SMA510WT



BLSMA510WT



SMA510V4WT



SMA510V4



SMA510V8ET

Big Tip



FROM LEFT TO RIGHT:
 SLATE GREY
 FORGET-ME-NOT
 WHITE
 MOSS GREEN
 BLUE
 BUTTERCUP
 GREEN
 GOLDEN YARROW
 RED
 HONEYSUCKLE
 YELLOW
 JUBILEE CHERRY
 BURNT SIENNA



Big Tip Markers

- SMA720WT** White Big Tip Bulk Pack
○
- BLSMA720WT** White Big Tip Blister 1-Pack
○
- SMA720V4WT** White Big Tip 4-Pack
○
- SMA720V4** Assortment Big Tip 4-Pack
(Green, Yellow, Blue, Red)
● ● ● ●
- SMA720V8ET** Earth Tone Assortment Big Tip 8-Pack
(Slate Gray, Forget-Me-Not, Moss Green, Buttercup, Golden Yarrow, Honeysuckle, Jubilee Cherry, Burnt Sienna)
● ● ● ● ● ● ● ●
- BLSMAMIXV5WT** White Multi Tip Blister 5-Pack
(1) Big Tip, (2) Small Tip, (2) Mini Tip
○

Stencil Set

With these transparent stencil letters, numbers and symbols, anyone can make impressively professional signage.

SECSTN5 Stencil Set
 9" L x 13" W (22.9 x 33 cm)





Wood Menu Holders

These versatile clipboards and rubberband boards can be used for full-service menus, bar service and check presentation. In your choice of style, color and size.

Bamboo Clipboards

- BB8** 4" W x 8" H (10.2 x 20.3 cm)
- BB4** 4 ½" W x 12 ½" H (11.4 x 31.8 cm)
- BB12** 9" W x 12 ½" H (22.9 x 31.8 cm)
- BB15** 9" W x 15 ½" H (22.9 x 39.4 cm)

Bamboo Rubberband Boards

- BBR12** 4 ½" W x 12 ½" H (11.4 x 31.8 cm)
- BBRB** 9" W x 12 ½" H (22.9 x 31.8 cm)
- BBR15** 9" W x 15 ½" H (22.9 x 39.4 cm)

Espresso Clipboards

- CB8** 4" W x 8" H (10.2 x 20.3 cm)
- CB4** 4 ½" W x 12 ½" H (11.4 x 31.8 cm)
- CB12** 9" W x 12 ½" H (22.9 x 31.8 cm)
- CB15** 9" W x 15 ½" H (22.9 x 39.4 cm)

Espresso Rubberband Boards

- CBRB12** 4 ½" W x 12 ½" H (11.4 x 31.8 cm)
- CBRB** 9" W x 12 ½" H (22.9 x 31.8 cm)
- CBR15** 9" W x 15 ½" H (22.9 x 39.4 cm)



Classic Menu Holders, Wine Card and Bill Presenter

For more classical presentation, these holders feature a faux leather finish with gold lettering or design, gold corner reinforcements, an elastic cord and a two-page plastic insert.

MCCRLSBI Beige Ivory Menu, 10" W x 13" H (25.4 x 33 cm)

MCCRLSBL Black Menu, 10" W x 13" H (25.4 x 33 cm)

MCCRLSWR Wine Red Menu, 10" W x 13" H (25.4 x 33 cm)

MCCWLSBL Black Wine Card with 2-Page Plastic Inserts
10" W x 13" H (25.4 x 33 cm)

MCCRBPBL Black Bill Presenter with Cash and Credit Card Sleeves
5" W x 9" H (12.7 x 22.9 cm)



Trendy Menu Holder and Bill Presenter

Details like a faux leather finish, double-sided stitching, debossed lettering, an elastic cord inside the spine and a two-page plastic insert make these a fantastic contemporary alternative to the traditional menu.

MCTRPBPL Black Bill Presenter with Cash and Credit Card Sleeve
5" W x 9" H (12.7 x 22.9 cm)

MCTRLSBL Black Menu, 10" W x 13" H (25.4 x 33 cm)





MCDRLSCORK

MCDWLSCORK



Cork Designer Menu Holder and Wine Card

Environmentally friendly cork is the key material in these premium, imaginative menu holders.

MCDRLSCORK Menu Holder
10" W x 13" H (25.4 x 33 cm)

MCDWLSCORK Wine Card
10" W x 13" H (25.4 x 33 cm)

Transparent Inserts

MCTILS 9" W x 12" H (22.9 x 30.5 cm)
Set of 10 Double Inserts
Each Displays (4) 8 1/2" x 11" Pages

MCTILS



FEATURES OPENINGS
FOR RECEIPTS, CARDS,
CASH AND PEN

WBB

WBW



MCBPBOXAN



MCBPBSS



MCBPBOXTR



Wood Block Check Presenters

Your customers will remember this compact, ultra-contemporary way to pay. In your choice of color.

WBB Bamboo
3 1/2" L x 2 3/4" W x 3 1/4" H
(8.9 x 7 x 8.3 cm)

WBW Espresso
3 1/2" L x 2 3/4" W x 3 1/4" H
(8.9 x 7 x 8.3 cm)



MCDBBPBL

Bill Presenter Treasure Box

The perfect way to end the meal! This Treasure Box can present bills, teas, even after-dinner treats.

MCBPBOXAN 6" L x 4" W x 4 1/4" H
(15.2 x 10.2 x 10.8 cm)

Securit Bill Presenters

MCBPBSS Stainless Steel
7 1/4" L x 3 5/8" W x 1/2" H
(18.4 x 9.2 x 1.3 cm)

MCBPBOXTR Faux Leather
7 1/4" L x 5" W x 1 1/2" H
(18.4 x 12.7 x 3.8 cm)

Leather and Wood Bill Presenter

A stitched black leather cover and solid wood base represent a premium restaurant experience. Includes a credit card holder.

MCDBBPBL 7 1/4" L x 4" W x 3/4" H
(18.4 x 10.2 x 1.9 cm)

Black Bill Presenter

This simple PVC presenter features two-page clear plastic sleeves and a credit card sleeve.

MCBRBPBL 5" W x 9 3/8" H
(12.7 x 23.8 cm)



MCBRBPBL



WBCG85



WBUBL70



WBUM60



WBUM60

EZLM165

DOUBLE-SIDED
FOR INSTANT
TRANSITIONS



EZLBL165

Antique Gold Framed Wall Boards

When in doubt, go for the gold. These attention-grabbing boards are an on-trend way to make your daily specials even more special. In your choice of two sizes.

- WBCG85** 24 3/4" W x 31 3/8" H (62.9 x 79.7 cm)
- WBCG105** 28 1/2" W x 38 3/8" H (72.4 x 97.5 cm) (not shown)

Deluxe Wall Boards

Make your signage impossible to miss with these double-sided wall boards. In two sizes and your choice of a mahogany or black frame. Wall-mounting hardware included.

- Mahogany**
- WBUM60** 22 1/4" W x 30" H (56.5 x 76.2 cm)
 - WBUM70** 26 1/4" W x 34 1/8" H (66.7 x 86.7 cm) (not shown)

- Black**
- WBUBL60** 22 1/4" W x 30" H (56.5 x 76.2 cm) (not shown)
 - WBUBL70** 26 1/4" W x 34 1/8" H (66.7 x 86.7 cm)

Wall Board Easels

- EZLM165** Mahogany 24" W x 65" H (61 x 165.1 cm)
- EZLBL165** Black 24" W x 65" H (61 x 165.1 cm)

Wall Boards

Natural black wood frames turn up the professionalism on these scratch-resistant boards. White Securit Chalk Marker, wall-mounting wire and hooks included.

- WBWBL2040** 7 3/4" W x 15 3/4" H (19.7 x 40 cm)
- WBWBL3040** 11 3/4" W x 15 3/4" H (29.8 x 40 cm)
- WBWBL4060** 15 3/4" W x 23 3/8" H (40 x 60 cm)
- WBWBL6080** 31 1/2" W x 23 3/8" H (80 X 60 cm)

Securit Black Chalkboard Paint

Turn any surface into a canvas for chalk with this special paint. Just put down a layer, and use Securit Chalk Markers to bring your menu to life.

- PNTBLSM** 8 1/2 oz. (251.4 mL)



WBWBL2040



WBWBL3040



WBWBL4060



WBWBL6080



PNTBLSM

EASILY CREATE A CHALKBOARD BY PAINTING ON SURFACES

HOT



SBSNG135



SBSN135



SBSM135



SBSB135



SBDBL85

Deluxe Sandwich Boards

The double-sided design and vibrant finishes on these premium sandwich boards make them ideal for catching eyes in high-traffic areas. Featuring robust, UV-resistant Securit writing surfaces that are suitable for all weather conditions.

Rustic Gray

SBSNG135 29 1/4" L x 43 1/4" W x 53 1/4" H
(74.3 x 109.9 x 135.3 cm)

Rustic Natural

SBSN135 29 1/4" L x 43 1/4" W x 53 1/4" H
(74.3 x 109.9 x 135.3 cm)

Mahogany

SBDM85 21 1/2" L x 2 1/4" W x 33 1/2" H
(54.6 x 5.7 x 85.1 cm)
(not shown)

SBSM135 28 1/8" L x 2 3/8" W x 54 3/4" H
(71.4 x 6 x 139.1 cm)

Plain

SBDB85 21 1/2" L x 2 1/4" W x 33 1/2" H
(54.6 x 5.7 x 85.1 cm)
(not shown)

SBSB135 28 1/8" L x 2 3/8" W x 54 3/4" H
(71.4 x 6 x 139.1 cm)

Sandwich Boards

These simple, smartly priced sandwich boards don't skimp on quality. Featuring natural black wood frames and scratch-resistant writing surfaces.

SBDBL85 21 1/2" L x 2 1/4" W x 33 1/2" H
(54.6 x 5.7 x 85.1 cm)

SBSBL120 27 1/4" L x 4" W x 49 1/4" H
(69.2 x 10.2 x 125.1 cm)
(not shown)



SPRV3



SPRV1



SPRV2

Free-Standing Smoker Poles

Maintain a comfortable space for all customers with this modern, inconspicuous cigarette disposal. Featuring screw-off top (on free-standing pole) or bottom (on wall-mounted pole) for quick emptying. Intended for outdoor use only.

- SPRV3** Gold
Free-Standing Smoker Pole & Base
15" Dia. x 40" H (38.1 x 101.6 cm)
- SPRV1** Brushed Stainless Steel
Free-Standing Smoker Pole & Base
15" Dia. x 40" H (38.1 x 101.6 cm)
- SPRV2** Black
Free-Standing Smoker Pole & Base
15" Dia. x 40" H (38.1 x 101.6 cm)

Replacement Caps

- SPGTP** Gold
- SPSLTP** Brushed Stainless Steel
- SPBLTP** Black

Wall-Mounted Smoker Pole

- SPSSWM2** Brushed Stainless Steel
Wall-Mounted Smoker Pole
2 1/2" Dia. x 22" H (6.4 x 55.9 cm)

BOTTOM SCREWS
OFF FOR EASY
EMPTYING



SPSSWM2



RBSS
(one set shown)

Value-Priced Barrier Systems 

The ideal way to control a crowd and ensure social distancing measures are clearly displayed. With a low price tag and sleek, modern design, these sets are the perfect social distancing solution. Set includes two poles, two bases and black nylon tape. Signs sold separately.

RBSS 84" Tape x 35 1/4" H Posts
(213.4 x 89.5 cm)
12 1/2" (31.8 cm) Dia. Bases

RBSBL 84" Tape x 35 1/4" H Posts
(213.4 x 89.5 cm)
12 1/2" (31.8 cm) Dia. Bases

NEW VALUE-PRICED SETS



RBSBL
(one set shown)



USE WITH CORRESPONDING
VALUE-PRICED BARRIER
SYSTEM SIGNS TO DISPLAY
KEY INFORMATION



RBSIGNBL shown with RBSBL barrier system

Value-Priced Barrier System Signs

Display important social distancing instructions with this two-sided, stainless steel sign. Simply slide it over the top of the post for instant customer communication.

Satin

RBSIGNS Vertical, Fits RBSS
8 ½" W x 11" H
(21.6 x 27.9 cm)

RBHSIGNS Horizontal, Fits RBSS
11" W x 8 ½" H
(27.9 x 21.6 cm)

Black

RBSIGNBL Vertical, Fits RBSBL
8 ½" W x 11" H
(21.6 x 27.9 cm)

RBHSIGNBL Horizontal, Fits RBSBL
11" W x 8 ½" H
(27.9 x 21.6 cm)





RSRTRD
(four sets shown)

USABLE INDOOR OR OUTDOOR



RSRTGY
(two sets shown)

RSRTBK
(two sets shown)



RSBPBL (two sets shown)

ALL BARRIER SYSTEMS ARE FOR BOTH INDOOR AND OUTDOOR USE

Retractable Barrier Systems

This versatile set extends your choice of nylon tape up to 84" (213.4 cm). Resilient nylon allows you to control the flow of customers in al fresco settings too. Set includes one post, nylon tape and one base.

Red Tape

RSRTRD Brushed Stainless Steel Post & Base
Red Nylon Tape
84" Tape x 40" H Post (213.4 x 101.6 cm)
15" (38.1 cm) Dia. Base

RSRTRVSRDC1 Replacement Post for RSRTRD

Gray Tape

RSRTGY Brushed Stainless Steel Post & Base
Gray Nylon Tape
84" Tape x 40" H Post (213.4 x 101.6 cm)
15" (38.1 cm) Dia. Base

RSRTRVSGYC2 Replacement Post for RSRTGY

Black Tape

RSRTBK Brushed Stainless Steel Post & Base
Black Nylon Tape
84" Tape x 40" H Post (213.4 x 101.6 cm)
15" (38.1 cm) Dia. Base

RSRTRVSBLC4 Replacement Post for RSRTBK

Replacement Parts

RSRTRVSC3 Replacement Base

XXRSRTCAP Replacement Top
2 1/2" Dia. x 1" H (6.4 x 2.5 cm)

Black Retractable Barrier System

Our classic barrier system, now available in sleek black-on-black styling. Extends up to 84" (213.4 cm). For indoor and outdoor use. Set includes one post, nylon tape and one base.

RSBPBL Black Matte Post & Base
Black Nylon Tape
84" Tape x 40" H Post
(213.4 x 101.6 cm)
15" (38.1 cm) Dia. Base

RSRTBLC8 Replacement Post

RSRTBLC9 Replacement Base

Retractable Barrier System Set

RSRTLWCH (2) Brushed Stainless Steel Posts & Bases
Black Nylon Tape
83" Tape x 37" H Posts (210 x 93 cm)
13" (33 cm) Dia. Bases



HOT

RSRTLWCH
(one set shown)

Retractable Barrier System Signs

Popular demand has prompted us to add these two-sided signs designed to be mounted on all Securit retractable barriers. Simply slide the sign over the top of the post for instant customer communication. Available in a satin and black finish, horizontal and vertical orientations.

Satin

RSSIGNLSPS Vertical, Fits RSRTRD, RSRTGY, RSRTBK and RSRTLWCH
8 1/2" W x 11" H (27.9 x 21.6 cm)

RHSSIGNLSPS Horizontal, Fits RSRTRD, RSRTGY, RSRTBK and RSRTLWCH
11 1/2" W x 8 1/2" H (29.2 x 27.9 cm)

Black

RSSIGNBLK Vertical, Fits RSBPBL
8 1/2" W x 11" H (27.9 x 21.6 cm)

RHSSIGNBLK Horizontal, Fits RSBPBL
11 1/2" W x 8 1/2" H (29.2 x 27.9 cm)

Retractable Barrier System Coasters

Designed to be used with a Securit Retractable Barrier System Sign, this coaster easily holds a bottle of sanitizer or cleaning spray. Simply screw off the sign, insert coaster, screw back on the sign - it is that easy. The ideal way to communicate safety messages and dispense sanitizer at the same time.

BCSS Satin
3 3/4" Dia. x 1 3/4" H
5 3/4" L with Handle (9.5 x 4.4, 14.6 cm)

BCB Black
3 3/4" Dia. x 1 3/4" H
5 3/4" L with Handle (9.5 x 4.4, 14.6 cm)



RSSIGNBLK shown with RSBPBL barrier system



RSSIGNLSPS shown with RSRTBK barrier system



RHSSIGNBLK



RHSSIGNLSPS



BCSS



BCB



RSLWCH

SET INCLUDES
TWO POSTS AND
TWO BASES

Rope Barrier System Set

Crafted from mirror-polished, high-grade stainless steel and featuring an anti-scratch base. Ropes sold separately.

RSLWCH (2) Bases and (2) Posts
12 1/2" Dia. x 37 1/4" H
(31.8 x 94.6 cm)

Deluxe Rope Barrier Systems

Finished with gold or silver to give your customers the Hollywood treatment. Set includes one post and one base.

Gold

RSCLG Classic Barrier
Gold-Plated Post & Base
15" Dia. x 40" H (38.1 x 101.6 cm)

RSCLGOA1 Replacement Post

RSCLGOA2 Replacement Base

Silver

RSCLC Classic Barrier Polished Chrome
Flat Head Post & Base
15" Dia. x 40" H (38.1 x 101.6 cm)

RSCLCHB1 Replacement Post

RSCLCHB2 Replacement Base



RSCLG (two sets shown
with RSCLRPGORD rope)



RSCLC (two sets shown
with RSCLRPCBU rope)



Barrier System Ropes

2" (5.1 cm) thick and 60" (5.1 x 152.4 cm) long, in your choice of elegant styles and colors. For both indoor and outdoor use.

Braided Rope

- RSCLRPGOBR** Bronze - Gold Ends
- RSCLRPCHBR** Bronze - Chrome Ends
- RSCLRPGOBL** Black - Gold Ends
- RSCLRPCHBL** Black - Chrome Ends

Velour Rope

- RSCLRPGORD** Red - Gold Ends
- RSCLRPCHRD** Red - Chrome Ends
- RSCLRPGOBU** Blue - Gold Ends
- RSCLRPCHBU** Blue - Chrome Ends

Wall Hooks for Rope Barrier System

Used to connect your Rope Barrier System (pg. 287) to walls. Mounting hardware included.

- RSCLWHCH** Chrome
2" L x 1 1/2" W
(5.1 x 3.8 cm)
- RSCLWHGO** Gold
2" L x 1 1/2" W
(5.1 x 3.8 cm)

Rope Barrier System Signs

Just unscrew the top of your Rope Barrier System and replace with a matching two-sided sign. Not for use with Retractable Barrier Systems.

- RSSIGNLSPG** Gold, Fits RSCLG
8 1/2" W x 11" H
(21.6 x 27.9 cm)
- RSSIGNLSPC** Chrome, Fits RSCLC
8 1/2" W x 11" H
(21.6 x 27.9 cm)

RSCLWHCH



RSCLWHGO

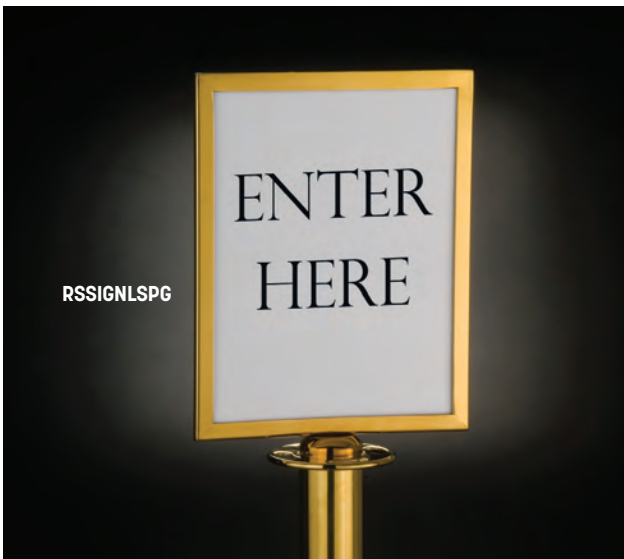

RSSIGNLSPG



RSSIGNLSPC



NEW



NEW

RBHMSG

Sign Sets NEW

Communicating to guests just got easier. We have taken the four most common statements and applied them to sleek black signage, perfect for any barrier sign. Sign set includes: Please Wait to be Seated, Please Enter Here, Section Closed and Carry-Out Pickup.

RBHMSG Horizontal Pack
10 3/4" W x 8" H
(27.3 x 20.3 cm)

RBVMSG Vertical Sign Pack
8" W x 10 3/4" H
(20.3 x 27.3 cm)



NEW

RBVMSG



DTSL7 shown with PTL24 and PTL14 plastic tumblers

DTSL2 shown with GGB76, GGSW5, GGSB5 bowls and SL76, SLS5 lids



DSD6

Safety Labels NEW

Keep foods covered and sealed for safety! These seals can be used on all surfaces from disposable To Go boxes to reusable grab & go containers. Strong enough to seal but easy enough to remove. Choose from round or rectangular shapes depending on your need.

- DTSL1** 1" Dia. (2.5 cm)
Roll of 1000 (not shown)
- DTSL2** 2" Dia. (5.1 cm)
Roll of 500
- DTSL7** 7" L x 3/4" W (17.8 x 1.9 cm)
Roll of 500

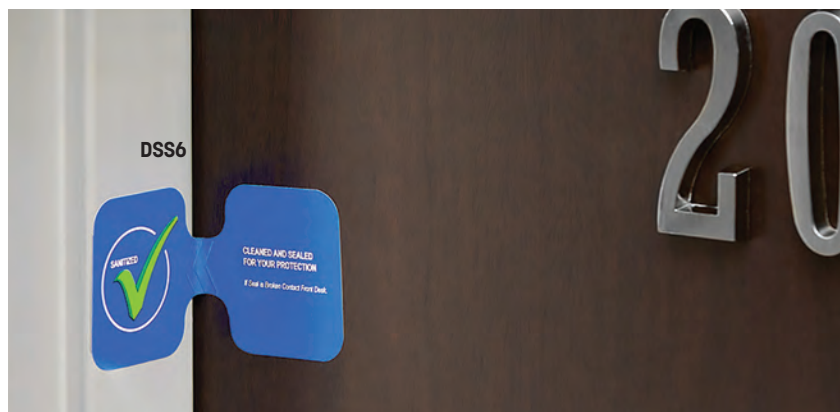

DSS6

Social Distancing Decals

Safely distance customers in areas where a minimum of six feet distance is required. These decals are perfect for placing on the ground to alert customers of restricted boundaries.

- DSD6** 6" Dia. (15.2 cm)
Pack of 40
- DSD12** 12" Dia. (30.5 cm)
Pack of 6 (not shown)

Sanitization Decals

Show guests and customers how you are adhering to the latest sanitizing guidelines. The door seal allows guests to feel comfort entering a room that has been just cleaned while the checklist offers a quick look at all sanitizing activities. The remote control label shows guests that safety is in the details. Ideal for hotels and resorts.

- DSS6** Sanitization Door Seal
6" L x 3" W (15.2 x 7.6 cm)
Roll of 500
- DSC4** Sanitization Checklist
4" Sq. (10.2 cm)
Roll of 500
- DSR6** Remote Control Label
6" L x 4" W (15.2 x 10.2 cm)
NEW **Roll of 500**



DSC4



DSR6



DSR6

PROTECTIVE BARRIERS

Arm any space against the spread of harmful germs and elements with our large collection of USA-made Protective Barriers. With acrylic and PVC designs, there are plenty of options to provide a safe and comfortable space for staff and customers.

Visit amnow.com to view the entire assortment of Protective Barriers.



VISIT AMNOW.COM TO VIEW ALL PROTECTIVE BARRIER OPTIONS



Bar Supplies





BUR18

NEW

BUR15

DRINKWARE

Poolside dining. Outdoor patios. Rooftop Bars. Today's hottest dining trends call for durable drinkware that can withstand the rigors of an outside environment while keeping environments safe from glass breakage. Enter American Metalcraft with a line of break-resistant, crystal clear Tritan™ drinkware in cool, trend-forward designs. Made of BPA-free Tritan copolyester, rest assured that our drinkware is lightweight, strong, stain-resistant and commercial dishwasher safe. The look of glass with the durability of plastic.

Unity Collection NEW BPA FREE

Sleek, clean lines define our Unity Collection drinkware. With a heavy base and slight taper, this crystal-clear Tritan line of glasses complements our Unity dinnerware collection entirely. Featuring capacities perfect for anything from Manhattans to flavored seltzers, this line is versatile for everyday use but provides a rich, upscale look for your trendiest bars.

BUR15 Double Old Fashioned
15 oz. (443.6 mL)
3" Dia. x 4 3/8" H (7.6 x 11.1 cm)

BUH18 Highball
18 oz. (532.3 mL)
2 3/4" Dia. x 6 1/4" H (7 x 15.9 cm)

Hadley Collection NEW BPA FREE

Old-fashioned charm meets current fashion with the Hadley Collection. Featuring a cut crystal look on durable Tritan drinkware, the Hadley line exudes pure elegance. Ideal for outdoor bars and lounges.

BHR14 Double Old Fashioned
14 oz. (354.9 mL)
3 3/8" Dia. x 4 1/2" H (8.6 x 11.4 cm)

BHH19 Highball
19 oz. (561.9 mL)
3 3/8" Dia. x 6 1/4" H (8.6 x 15.9 cm)



BHH19

NEW

BHR14

Shown with STWG8 stainless steel straw, OWP157 peel and HMMJ5, HMMJ4 mini apothecary jars

NEW



Lilli Collection NEW BPA FREE

Your grandmother's vintage glassware has achieved a new life. Our Lilli Collection features a fresh embossed design that provides a nostalgic feel. Made with BPA-free Tritan copolyester, these glasses have the delicate look of glass with the durability of plastic.

BLR14 Double Old Fashioned
14 oz. (354.9 mL)
3 1/4" Dia. x 4 1/2" H (8.3 x 11.4 cm)

BLH19 Highball
19 oz. (561.9 mL)
3 3/8" Dia. x 6 1/4" H (8.6 x 15.9 cm)

Sanibel Collection NEW BPA FREE

A classic everyday look, the Sanibel Collection features a weighted base and cut crystal design. A perfect choice for ice cold water, cocktails or soft drinks, this line of clear, resilient Tritan drinkware provides a refreshing twist on a hot summer day.

BSR14 Double Old Fashioned
14 oz. (354.9 mL)
3 3/8" Dia. x 3 3/4" H (8.6 x 9.5 cm)

BSH20 Highball
20 oz. (591.5 mL)
3 1/8" Dia. x 6 1/8" H (7.9 x 15.6 cm)

NEW



Shown with WBC36 water bottle and STWS10 stainless steel straw



OUR BIGGEST MUG MEASURES IN AT AROUND A GALLON AND A HALF (YES, REALLY) TO QUENCH EVEN THE THIRSTIEST CROWDS

CM96H

CM192H

Shown with
 STWB10, STWS10, STWC10, STWG10 stainless steel straws,
 AWB12 rimmed oval ashwood serving board,
 MDLR10 stainless steel muddler and
 CM16H Moscow mule mug

MOSCOW MULE MUGS

In a range of sizes and finishes, our trendy Moscow Mule Mugs can accommodate individual drinks or shareable cocktails. Or, for an outside-the-box conversation piece, load them up with food.

Jumbo Hammered Copper Moscow Mule Mugs

- CM96H** 96 oz. (2.8 L)
6" Dia. x 6 5/8" H (15.2 x 16.8 cm)
- CM192H** 192 oz. (5.7 L)
7 1/2" Dia. x 8 1/8" H (19.1 x 20.6 cm)

Moscow Mule Mugs HOT

Copper/Brass

- CM16H** Hammered Finish
16 oz. (473.2 mL)
3 3/4" Dia. x 4 3/4" H
(9.5 x 12.1 cm)
- CM16P** Mirror Finish
16 oz. (473.2 mL)
3 3/4" Dia. x 4 3/4" H
(9.5 x 12.1 cm)

Gold/Brass

- GM16H** Hammered Finish
16 oz. (473.2 mL)
3 3/4" Dia. x 4 3/4" H
(9.5 x 12.1 cm)
- GM16P** Mirror Finish
16 oz. (473.2 mL)
3 3/4" Dia. x 4 3/4" H
(9.5 x 12.1 cm)

Black/Brass

- BM16H** Hammered Finish
16 oz. (473.2 mL)
3 3/4" Dia. x 4 3/4" H
(9.5 x 12.1 cm)
- BM16P** Mirror Finish
16 oz. (473.2 mL)
3 3/4" Dia. x 4 3/4" H
(9.5 x 12.1 cm)





THE ANTIQUE COPPER COLLECTION

Natural elements and minerals are on-trend. So it just made sense to add all of these copper mugs, tumblers, mini mule mugs, cocktail shakers and bar accessories to our line. Mix, stir, shake and toast... Here's to you.

Antique Copper Moscow Mule Tumblers

- ACT** Satin Finish, 14 oz. (414 mL)
2 ¾" Dia. x 3 ½" H (7 x 8.9 cm)
- ACTH** Hammered Finish, 14 oz. (414 mL)
2 ¾" Dia. x 3 ½" H (7 x 8.9 cm)

Antique Copper Moscow Mule Mugs

- ACM** Satin Finish, 14 oz. (414 mL)
2 ¾" Dia. x 3 ½" H (7 x 8.9 cm)
- ACMH** Hammered Finish, 14 oz. (414 mL)
2 ¾" Dia. x 3 ½" H (7 x 8.9 cm)

Antique Copper Cups

- ACC** Satin Finish, 14 oz. (414 mL)
3 ⅞" Dia. x 3 ½" H (7.9 x 8.9 cm)
- ACCH** Hammered Finish, 14 oz. (414 mL)
3 ⅞" Dia. x 3 ½" H (7.9 x 8.9 cm)





Stainless Steel Straws

Do your part in protecting the environment—and make a style statement in the process—with these washable, reusable straws. **Sold in packs of 12.**

Copper

- STWC6 6" L (15.2 cm)
- STWC8 8" L (20.3 cm)
- STWC10 10" L (25.4 cm)

Silver

- STWS6 6" L (15.2 cm)
- STWS8 8" L (20.3 cm)
- STWS10 10" L (25.4 cm)

Gold

- STWG6 6" L (15.2 cm)
- STWG8 8" L (20.3 cm)
- STWG10 10" L (25.4 cm)

Black

- STWB6 6" L (15.2 cm)
- STWB8 8" L (20.3 cm)
- STWB10 10" L (25.4 cm)

Stainless Steel Straw Basket

- STWBSKT 4" Sq. x 6 ¾" H (10.2 x 17.2 cm)

Stainless Steel Straw Cleaner

- STWBRSH 12" L (30.5 cm)

6" STRAWS



8" STRAWS



10" STRAWS





Double-Wall Martini Glasses

In a satin or hammered stainless steel design, these glasses perform double duty for beverages or bar snacks.

DWC7 Satin Finish, 7 oz. (207 mL)
4 1/2" Dia. x 3 3/4" H
(11.4 x 9.5 cm)

DWCH7 Hammered Finish, 7 oz. (207 mL)
4 1/2" Dia. x 3 3/4" H
(11.4 x 9.5 cm)

Martini Glass Servers

Use these stainless steel martini glasses for their obvious purpose or for serving snacks, appetizers and other finger foods.

MART1 10 oz. (295.7 mL)
5 7/8" Dia. x 8 1/4" H x 2 1/2" Deep
(14.9 x 21 x 6.4 cm)

JMART15 80 oz. (2.4 L)
9" Dia. x 15" H x 5 1/4" Deep
(22.9 x 38.1 x 13.3 cm)

Moroccan Tumbler

Whether you use this tumbler for creative beverage service or even more imaginative food presentation, it delivers a handcrafted aesthetic. Made of stainless steel.

HV3 Silver
12 oz. (354.9 mL)
3 1/4" Dia. x 4 1/4" H
(8.3 x 10.8 cm)

Shown with
FSLT10 faux slate
melamine platter

GREAT FOR FOOD OR DRINK



Hammered Double-Wall Cups and Tumblers

Make a splash at the bar with these hammered, mirrored-finish stainless steel designs in three different colors.

Copper

HMTC12 Tumbler
12 oz. (354.9 mL)
3 ¾" Dia. x 4" H
(9.5 x 10.2 cm)

HMTC14 Mule Cup
14 oz. (414 mL)
3 ½" Dia. x 4 ½" H
(8.9 x 11.4 cm)

HMTC16 Tumbler
16 oz. (473.2 mL)
3 ½" Dia. x 5 ¾" H
(8.9 x 14.6 cm)

Silver

HMTS12 Tumbler
12 oz. (354.9 mL)
3 ¾" Dia. x 4" H
(9.5 x 10.2 cm)

HMTS14 Mule Cup
14 oz. (414 mL)
3 ½" Dia. x 4 ½" H
(8.9 x 11.4 cm)

HMTS16 Tumbler
16 oz. (473.2 mL)
3 ½" Dia. x 5 ¾" H
(8.9 x 14.6 cm)

Black

HMTB12 Tumbler
12 oz. (354.9 mL)
3 ¾" Dia. x 4" H
(9.5 x 10.2 cm)

HMTB14 Mule Cup
14 oz. (414 mL)
3 ½" Dia. x 4 ½" H
(8.9 x 11.4 cm)

HMTB16 Tumbler
16 oz. (473.2 mL)
3 ½" Dia. x 5 ¾" H
(8.9 x 14.6 cm)



CREATIVE COCKTAILS CALL FOR CREATIVE CUPS, AND WE HAVE ONE FOR EVERY OCCASION



Shown with STWS10 stainless steel straw and SST14 Royal Touch serving tray

Alternative Drinking Vessels

Mix up cups, bottles and jars to achieve creative, interesting service for beverages of all types.

- MJ17** Mason Jar
17 oz. (502.8 mL)
3 3/8" Dia. x 5 3/8" H (8.6 x 13.7 cm)
- GMB8** Glass Milk Bottle
8 oz. (236.6 mL)
2 1/4" Dia. x 5 1/2" H (5.7 x 14 cm)
- JC11** Mint Julep Cup
11 oz. (325.3 mL)
3" Dia. x 4 1/4" H (8.3 x 10.8 cm)
- HV3** Moroccan Tumbler
12 oz. (354.9 mL)
3 1/4" Dia. x 4 1/4" H (8.3 x 10.8 cm)
- MICH15** Stainless Steel Milk Can
15 oz. (443.6 mL)
2 3/4" Dia. x 5" H (7 x 12.7 cm)
- GMB16** Glass Milk Bottle
16 oz. (473.2 mL)
2 3/4" Dia. x 6 1/2" H (7 x 16.5 cm)
- GJ8** Square Glass Jar
8 oz. (236.6 mL)
3" Sq. x 3" H (7.6 x 7.6 cm)
- MJ85** Mason Jar
8 1/2 oz. (250 mL)
3" Dia. x 4" H (7.6 x 10.2 cm)



Classic Mint Julep Cups

Featuring elegant beading and a mirrored finish, these stunning cups will have your mint julep presentation off to the races.

- JC12** 12 oz. (354.9 mL)
3 3/8" Dia. x 4 1/2" H (8.6 x 11.4 cm)
- JC16** 16 oz. (473.2 mL)
3 5/8" Dia. x 5 3/4" H (9.2 x 14.6 cm)
- JC48** 48 oz. (1.4 L)
5 1/4" Dia. x 7 5/8" H (13.3 x 19.4 cm)

Mint Julep Cups

Make every day Derby Day with these sleek Mint Julep Cups crafted from brushed stainless steel.

- JC8** 8 oz. (236.6 mL)
2 7/8" Dia. x 3 7/8" H (7.4 x 9.8 cm)
- JC11** 11 oz. (325.3 mL)
3" Dia. x 4 1/4" H (7.6 x 10.8 cm)
- JC14** 14 oz. (414 mL)
3 1/4" Dia. x 4 5/8" H (8.3 x 11.8 cm)

Carbonized Bamboo Flight Boards

The rich color of these flight boards brings out the best in brews and bites alike.

BWF4 Flight Board
13 7/8" L x 3 3/8" W x 1 1/4" H
(35.2 x 8.6 x 3.2 cm)

BWF3 Pairing Flight Board
13 7/8" L x 6 7/8" W x 1 1/4" H
(35.2 x 17.5 x 3.2 cm)

Mini Glass Mason Jars

Set these up on one of our flight boards for craft beer tastings. **Sold in a set of 4.**

MMJS 4 oz. (118.3 mL)
5" L x 4 3/4" W x 4" H
(12.7 x 12.1 x 10.2 cm)



AT JUST 4 OZ., THESE MINI MUGS ARE PERFECT FOR FLIGHT BOARDS OR TASTINGS





PLASTIC SHAKERS ARE GREAT FOR CARRY OUT COCKTAILS!

USA

Plastic Cocktail Shakers

Shake up a carry out cocktail with one of these perfectly plastic 3-piece cocktail shakers. Made of break-resistant polystyrene, these shakers can be used over and over.

- PCS8** 8 oz. (236.6 mL)
2 3/4" Dia. x 6 3/4" H
(6.9 x 17.1 cm)
- PCS16** 16 oz. (473.2 mL)
3 1/2" Dia. x 7 5/8" H
(8.9 x 19.4 cm)
- PCS24** 24 oz. (709.8 mL)
3 1/2" Dia. x 11" H
(8.9 x 27.9 cm)



USA

Plastic Tumblers with Lids

Carry-out drinks and cocktails take on a new twist with these durable, reusable polystyrene tumblers. Available in the most popular capacities, these cups are made to go where you go. Each tumbler comes with a lid.

- PTL12** 12 oz. (354.9 mL)
3 3/8" Dia. x 4" H
(8.6 x 10.2 cm)
- PTL14** 14 oz. (414 mL)
3 3/8" Dia. x 4 7/8" H
(8.6 x 12.4 cm)
- PTL20** 20 oz. (591.5 mL)
3 3/8" Dia. x 6" H
(8.6 x 15.2 cm)
- PTL24** 24 oz. (709.8 mL)
3 3/8" Dia. x 8 1/2" H
(8.6 x 21.6 cm)
- PCTL** Clear Replacement Lid
Fits PTL12, PTL14, PTL20, PTL24
Pack of 25



USA

Plastic Cups with Lids

Serve up a shot of flavor with these polystyrene cups. Ideal for prepping, storing and serving anything from sauces to drinks. The accompanying clear cap allows for easy transport and delivery.

- PMC15** 1 1/2 oz. (44.4 mL)
1 7/8" Dia. x 2 1/8" H
(4.8 x 5.4 cm)
Pack of 12
- PMC2** 2 oz. (59.1 mL)
1 7/8" Dia. x 2" H
(4.8 x 5.1 cm)
Pack of 12
- PMC3** 3 oz. (88.7 mL)
1 7/8" Dia. x 2 7/8" H
(4.8 x 7.3 cm)
Pack of 6

USE WITH SAFETY LABELS ON PG. 313



Plastic Beverage Bottles

These clear PET one-time use beverage bottles make for ideal to-go drink options. The aluminum screw-on lid adds to the sleek design. **Sold in a pack of 12.**

- BV8** 8 oz. (236.6 mL)
NEW 2 3/8" Dia. x 4 1/2" H
 (6 x 11.4 cm)
- BV12** 12 oz. (354.9 mL)
NEW 3" Dia. x 4 3/4" H
 (7.6 x 12.1 cm)
- BV16** 16 oz. (473.2 mL)
 3" Dia. x 5 3/4" H
 (7.6 x 14.6 cm)
- BV20** 20 oz. (591.5 mL)
 3" Dia. x 6 3/4" H
 (7.6 x 17.1 cm)

Plastic Mason Jars USA

Love the look of a mason jar but the durability of plastic? We have the answer with our crystal clear, break-resistant plastic mason jars. Top it off for travel with our plastic lid option (sold separately).

- PMJ16** 16 oz. (473.2 mL)
 3 1/4" Dia. x 4 5/8" H
 (8.3 x 16.5 cm)
- PMJ26** 26 oz. (768.9 mL)
 3 1/2" Dia. x 5 1/2" H
 (8.9 x 14 cm)
- PMJL** Silver Lid
 Fits PMJ16, PMJ26, MJ85 and MJ17



PMJ26 shown with PMJL lid

PMJ16 shown with PMJL lid

Shown with BHR14 drinkware and BSS12 bar spoon

NEW



Shown with MSTNG5 tongs

COCKTAIL PREP

With the cocktail craze in full swing, it's not enough to make great drinks. You have to look good doing it. As mixology methods become more refined, bartending experts look to step up their game with accessories that match their liquid assets. These pieces raise the bar for preparation and presentation.

Cocktail Mixing Tins NEW

Mix up ice cold cocktails with a modern twist with these new stainless steel mixing tins. Featuring a contemporary satin-finished design, each drink will pour with ease from the precision spout. Durable and dishwasher safe.

- MTS20** 20 oz. (591.5 mL)
3 3/8" Dia. x 4 1/4" H (8.6 x 10.8 cm)
- MTS26** 26 oz. (768.9 mL)
3 1/2" Dia. x 5" H (8.9 x 12.7 cm)
- MTS32** 32 oz. (946.4 mL)
4" Dia. x 5 1/2" H (10.2 x 14 cm)

Cocktail Mixing Glasses

In 20, 25 and 30 oz. capacities, this barware is available in stemmed, clear, diamond and hand-cut glass designs.

Stemmed

- MGS30** 30 oz. (887.2 mL)
3 1/2" Dia. x 7 1/4" H (8.9 x 18.4 cm)

Clear

- MGC20** 20 oz. (591.5 mL)
3 1/2" Dia. x 5 1/4" H (8.9 x 13.3 cm)
- MGC25** 25 oz. (739.3 mL)
3 1/2" Dia. x 6 1/2" H (8.9 x 16.5 cm)

Diamond

- MGD20** 20 oz. (591.5 mL)
3 1/2" Dia. x 5 1/4" H (8.9 x 13.3 cm)
- MGD25** 25 oz. (739.3 mL)
3 1/2" Dia. x 6 1/2" H (8.9 x 16.5 cm)

Hand-Cut

- MGL20** 20 oz. (591.5 mL)
3 1/2" Dia. x 5 1/4" H (8.9 x 13.3 cm)
- MGL25** 25 oz. (739.3 mL)
3 1/2" Dia. x 6 1/2" H (8.9 x 16.5 cm)

Glass Bitters Bottles

Choose from three different designs that include a stainless steel and silicone stopper.

- BB3** Clear, 2 oz. (59.1 mL)
2 1/2" Dia. x 5 1/4" H (6.3 x 13.3 cm)
- BB2** Clear, 4 oz. (118.3 mL)
3" Dia. x 6 1/4" H (7.6 x 15.9 cm)
- BBC2** Diamond, 4 oz. (118.3 mL)
2 1/2" Dia. x 6" H (6.4 x 15.2 cm)
- BBRC** Replacement Silicone Dasher (not shown)
1" Dia. x 2 1/2" H (2.5 x 6.3 cm)



BEAUTIFUL DIAMOND PATTERN



GORGEOUS HAND-CUT DESIGN



BEAUTIFUL DIAMOND DETAILS

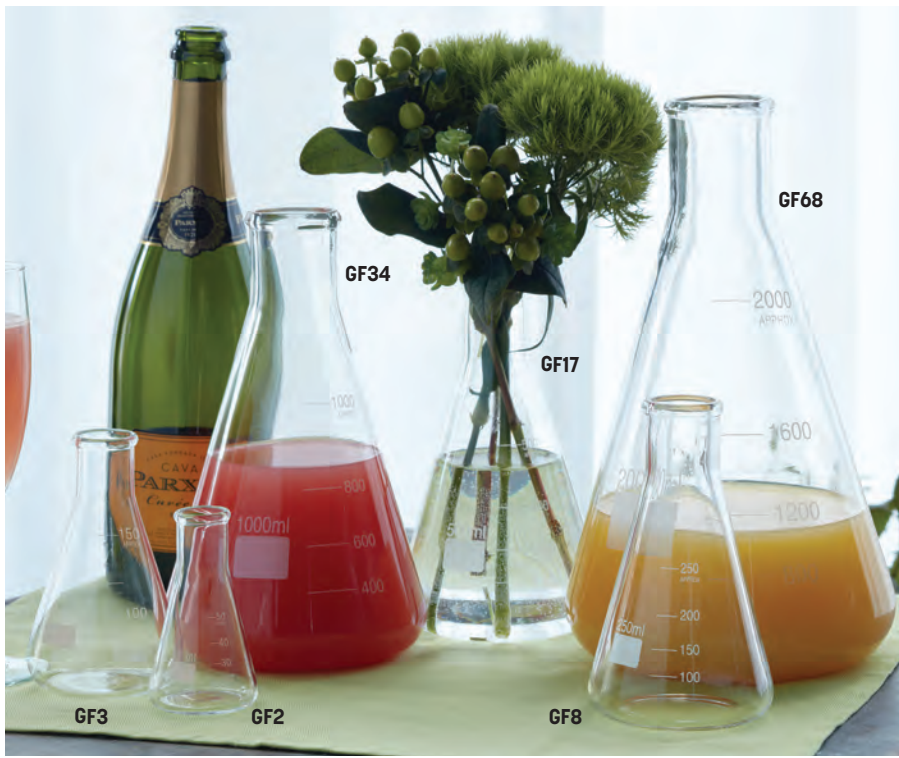

THE CHEMISTRY COLLECTION

Create your most inspired concoctions with these flasks and beakers that make even classic cocktails feel experimental. Capacity markings make measurement easy.

Glass Chemistry Flasks

- GF2** 1 ¾ oz. (50 mL)
2" Dia. x 3 ¾" H (5.1 x 9.5 cm)
- GF3** 5 oz. (150 mL)
3" Dia. x 4 ¾" H (7.6 x 12.1 cm)
- GF8** 8 ½ oz. (250 mL)
3 ½" Dia. x 5 ¾" H (8.9 x 14.6 cm)
- GF17** 17 oz. (500 mL)
4" Dia. x 7" H (10.2 x 17.8 cm)
- GF34** 34 oz. (1000 mL)
5" Dia. x 8 ¾" H (12.7 x 22.2 cm)
- GF68** 68 oz. (2000 mL)
6 ½" Dia. x 11" H (16.5 x 27.9 cm)

Glass Chemistry Beakers

- GBE2** 1 ¾ oz. (50 mL)
1 ¾" Dia. x 2 ¼" H (4.5 x 5.7 cm)
- GBE3** 3 ½ oz. (100 mL)
2 ½" Dia. x 3" H (6.4 x 7.6 cm)
- GBE8** 8 ½ oz. (250 mL)
3" Dia. x 4" H (7.6 x 10.2 cm)
- GBE17** 17 oz. (500 mL)
3 ¼" Dia. x 5" H (8.3 x 12.7 cm)
- GBE34** 34 oz. (1000 mL)
4 ¼" Dia. x 5 ¼" H (10.8 x 13.3 cm)
- GBE64** 64 oz. (2000 mL)
5 ¼" Dia. x 7 ½" H (13.3 x 19.1 cm)



CAPACITIES ARE
CLEARLY MARKED



Glass Water Bottles and Stoppers

Mix and match two styles of carafes and three styles of stoppers to elevate your H₂O. Bottles and stoppers sold separately.

Glass Water Bottles

- GCD28** Diamond
29 oz., 28 oz. to Shoulder (0.9 L, 0.8 L)
3 1/8" Dia. x 10 1/4" H (7.9 x 26 cm)
- GCH28** Pebbled
29 oz., 28 oz. to Shoulder (0.9 L, 0.8 L)
3 1/8" Dia. x 10 1/4" H (7.9 x 26 cm)

Glass Bottle Stoppers

- GSB2** Blue Marble, 1 3/4" Dia. x 2 3/4" H (4.4 x 7 cm)
- GSC2** Clear, 1 3/4" Dia. x 2 3/4" H (4.4 x 7 cm)
- GSF2** Frosted, 1 3/4" Dia. x 2 3/4" H (4.4 x 7 cm)

Glass Carafes

With smaller sizes for individual servings of beverages or soups, and larger sizes for shared drinks, these elegantly curved carafes are a stylish addition to any brunch or dinner service.

Multi-Serving

- GC36** 36 oz., 34 oz. to Shoulder (1.1 L, 1 L)
4" Dia. x 9 1/2" H (10.2 x 24.1 cm)
- GC34** 34 oz., 16 oz. to Shoulder (1 L, 473.2 mL)
4" Dia. x 9 1/2" H (10.2 x 24.1 cm)

Single-Serving

- GC12** 12 oz., 10.5 oz. to Shoulder (354.9 mL, 310.5 mL)
3 1/4" Dia. x 4 3/4" H (8.2 x 12 cm)
- GC8** 8 oz., 3 oz. to Shoulder (236.6 mL, 88.7 mL)
3" Dia. x 4 3/4" H (7.6 x 12 cm)



CHECK OUT PG. 96 FOR ADDITIONAL WATER BOTTLE OPTIONS



Shown with WB32 Water Bottle



USE WITH CLEAR ACRYLIC WATER BOTTLES

Clear Acrylic Water Bottles

In a quartet of distinct styles, these one-liter acrylic bottles make even simple beverages photogenic. Cap included.

WB32 Clear, 34 oz. (1 L)
 3 1/2" Dia. x 11 1/4" H
(8.9 x 28.6 cm)

WB33 Fluted, 34 oz. (1 L)
3 1/2" Dia. x 11 1/4" H
(8.9 x 28.6 cm)

WB34 Pebbled, 34 oz. (1 L)
3 1/2" Dia. x 11 1/4" H
(8.9 x 28.6 cm)

WB35 Diamond 34 oz. (1 L)
 3 1/2" Dia. x 11 1/4" H
(8.9 x 28.6 cm)

WBCAP Replacement Cap
1" Dia. x 1" H
(2.5 x 2.5 cm)

Stainless Steel Tapered Pourer

Turn one of our Clear Acrylic Water Bottles into a jumbo-sized mixer bottle with this pourer made from stainless steel and plastic cork. It's a memorable way to give your bar an extra splash of panache. **Sold in a pack of 12.**

DPR1 Stainless Steel Pourer
Fits WB32, WB33, WB34, WB35
1 3/4" Dia. x 4 3/4" H
(4.4 x 12.1 cm)



Black Silicone Ice Molds



All are made of dishwasher-safe, BPA-free, food-safe silicone and withstand temperatures from -4° F (-20° C) to 392° F (200° C).

Sphere Molds

SMSR4 (4) 2 1/2" Dia. (6.4 cm)
4 oz. (118.3 mL)
6 1/8" Sq. x 2 1/2" H (15.6 x 6.4 cm)
2 Pieces with Lid

SMSR8 (6) 1 1/2" Dia. (3.8 cm)
1 3/4 oz. (51.8 mL)
7" L x 4 5/8" W x 1 1/2" H
(17.8 x 11.7 x 3.8 cm)
2 Pieces with Lid

Cube Molds

SMSC4 (4) 2" Sq. (5.1 cm)
3 1/2 oz. (103.5 mL)
4 1/2" Sq. x 2" H (11.4 x 5.1 cm)
2 Pieces with Lid

SMSC8 (8) 2" Sq. (5.1 cm)
3 1/2 oz. (103.5 mL)
8 1/2" L x 4 1/2" W x 2" H
(21.6 x 11.4 x 5.1 cm)



MOLDS CREATE PERFECTLY
SQUARE (OR ROUND) ICE



Antique Copper Cocktail Shakers

Part of our award-winning Antique Copper Collection, these cocktail shakers do more than mix drinks—they spark conversations.

- ACS** Satin, 24 oz. (710 mL)
4" Dia. x 9 1/4" H (10.2 x 23.5 cm)
- ACSH** Hammered, 24 oz. (710 mL)
4" Dia. x 9 1/4" H (10.2 x 23.5 cm)

Beehive Cocktail Shakers

These three-piece beehive stainless steel shakers feature a high-polished mirror finish on the shaker, strainer top and jigger cap.

- BHS109** 8 oz. (240 mL)
2 5/8" Dia. x 6 3/8" H (6.7 x 16.2 cm)
- BHS117** 16 oz. (470 mL)
3 1/4" Dia. x 8" H (8.3 x 20.3 cm)
- BHS124** 24 oz. (710 mL)
3 1/2" Dia. x 8 7/8" H (8.9 x 22.5 cm)

Boston Shaker Set

Chill it, shake it and serve it! These weighted satin-finish stainless steel tins fit firmly together to mix up your favorite cocktails. Available in a set or as individual sizes.

- BSSET** 18 oz. (532.3 mL)
3 3/8" Dia. x 5 1/4" H (8.6 x 13.3 cm)
- 28 oz. (828.1 mL)
3 5/8" Dia. x 7" H (9.2 x 17.8 cm)

Replacement Cups

- BS18** 18 oz. (532.3 mL)
3 3/8" Dia. x 5 1/4" H (8.6 x 13.3 cm)
- BS28** 28 oz. (828.1 mL)
3 5/8" Dia. x 7" H (9.2 x 17.8 cm)



Three-Piece Cocktail Shakers HOT 

- CSJ108** 8 oz. (240 mL)
3 1/8" Dia. x 5 3/4" H (7.9 x 14.6 cm)
- CSJ116** 16 oz. (470 mL)
3 1/8" Dia. x 7 1/2" H (7.9 x 19.1 cm)
- CSJ174** 28 oz. (830 mL)
4" Dia. x 8 1/4" H (10.2 x 21 cm)

Replacement Jigger Cup

- CSJCUP** 3 oz. (8.8 mL) (not shown)
2" Dia. x 2 1/4" H (5.1 x 5.7 cm)

Cocktail Shakers and Malt Cup HOT 

- CS080** Shaker
8 oz. (240 mL)
3" Dia. x 3 1/4" H (7.6 x 8.3 cm)
- CS200** Shaker
16 oz. (470 mL)
3 3/4" Dia. x 4 5/8" H (9.5 x 11.7 cm)
- CS100** Shaker
28 oz. (800 mL)
3 5/8" Dia. x 7" H (9.2 x 17.8 cm)
- MM100** Malt Cup
32 oz. (950 mL)
4 1/8" Dia. x 7" H (10.5 x 17.8 cm)

Bar Glass/Mixing Glass USA 

- MG578** 16 oz. (470 mL)
3 5/8" Dia. x 5 7/8" H (8.6 x 14.9 cm)

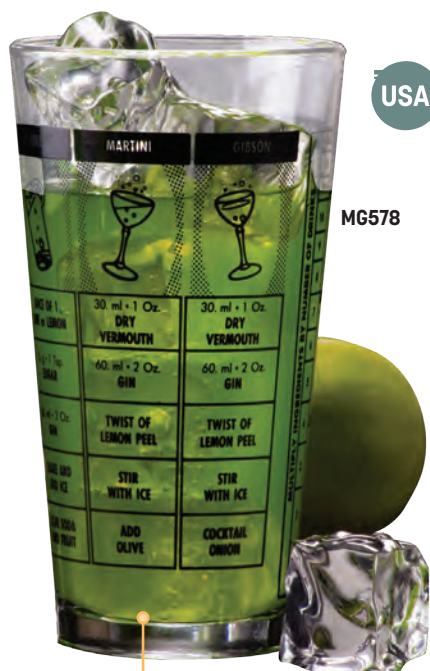

COMES COMPLETE WITH INSCRIBED RECIPES



ANTIQUE COPPER OUTSIDE,
STAINLESS STEEL FINISH
INSIDE



SEE PG. 340 FOR
ADDITIONAL
COLOR OPTIONS

CLEARLY MARKED
IN OZ.

Antique Copper Jiggers

- ACJ2 ½ oz. x ¾ oz. (14.8 x 22.2 mL)
- ACJ1 ½ oz. x 1 oz. (14.8 x 29.6 mL)
- ACJ4 1 oz. x 1½ oz. (29.6 x 44.4 mL)
- ACJ 1 oz. x 2 oz. (29.6 x 59.1 mL)
- ACJA ¾ oz. x 1¼ oz. (22.2 x 37 mL)
- ACJ12 ½ oz. x 1½ oz. (14.8 x 44.4 mL)

Japanese-Style Stainless Steel Jiggers

- JG2 ½ oz. x ¾ oz. (14.8 x 22.2 mL)
- JG1 ½ oz. x 1 oz. (14.8 x 29.6 mL)
- JG12 ½ oz. x 1½ oz. (14.8 x 44.4 mL)
- JG14 ½ oz. x 1¼ oz. (14.8 x 37 mL)
- JG22 1 oz. x 1¼ oz. (29.6 x 37 mL)
- JG2A ¾ oz. x 1¼ oz. (22.2 x 37 mL)
- JG3 ¾ oz. x 1½ oz. (22.2 x 44.4 mL)
- JG4 1 oz. x 1½ oz. (29.6 x 44.4 mL)
- JG5 1 oz. x 2 oz. (29.6 x 59.1 mL)
- JG63 1¼ oz. x 2 oz. (37 x 59.1 mL)

Stainless Steel Jiggers

- J202 ½ oz. x ¾ oz. (14.8 x 22.2 mL)
- J201 ½ oz. x 1 oz. (14.8 x 29.6 mL)
- J214 ½ oz. x 1¼ oz. (14.8 x 37 mL)
- J212 ½ oz. x 1½ oz. (14.8 x 44.4 mL)
- J208 ⅝ oz. x 1¼ oz. (18.5 x 37 mL)
- J206 ¾ oz. x 1 oz. (22.2 x 29.6 mL)
- J202A ¾ oz. x 1¼ oz. (22.2 x 37 mL)
- J203 ¾ oz. x 1½ oz. (22.2 x 44.4 mL)
- J222 1 oz. x 1¼ oz. (29.6 x 37 mL)
- J204 1 oz. x 1½ oz. (29.6 x 44.4 mL)
- J205 1 oz. x 2 oz. (29.6 x 59.1 mL)
- J263 1¼ oz. x 2 oz. (37 x 59.1 mL)
- J266 1½ oz. x 2 oz. (44.4 x 59.1 mL)



Evolution Tongs

These stainless steel tongs feature a 21st-century design with ergonomic styling.

- TGS7 7" L (17.8 cm)
- TGS8 7¼" L (18.4 cm)
- TGS6 6" L (15.2 cm)
- TGS9 9½" L (24.1 cm)
- TGS12 12" L (30.5 cm)





MSTNG5

ICETNG

Stainless Steel Ice Tongs

The serrated claws on these short tongs make gripping a breeze when time is at a premium.

MSTNG5 5" L (12.7 cm)

ICETNG 5 ¼" L (13.3 cm)

Stainless Steel Bar Tongs

Who says tongs need to have an everyday look? These bar tongs are anything but boring.

TGC Circle, 6 ½" L (15.5 cm)

TGP Pronged, 6" L (15.2 cm)

TGS Spoon, 7" L (17.7 cm)

Serving Tongs

These versatile brushed stainless steel tongs can be used for anything from bread to ice cubes.

TG8 Solid, 8 ½" L (21.6 cm)

TGP8 Perforated, 8 ½" L (21.6 cm)

Stainless Steel Utility Tongs

Your basic utility tongs never go out of style.

UT707 7" L (17.8 cm)



TGS

TGC

TGP



TG8

TGP8



UT707

Shown with GBE8 glass beaker



Stainless Steel Bar Whisks

Cocktailing is an art. These whisks are a mixologist's right-hand memory maker.

- SBW5** Square
NEW 5" L (12.7 cm)
- SBW7** Square
NEW 7" L (17.8 cm)
- SBW9** Round
9" L (22.9 cm)
- SBW10** Square
10 ½" L (26.6 cm)

Stainless Steel Bar Utensils

The bartender's arsenal of tools, all in one stylish collection. Each of these utensils is crafted from stainless steel and tipped with black rubber.

- SZ56** Zester
6 ¾" L (17.1 cm)
- SB07** Bottle Opener
7 ¾" L (19.7 cm)
- SSS8** 2-Prong Bar Strainer
8 7/8" L (22.5 cm)
- SM9** Cocktail Muddler
9 1/8" L (23.2 cm)

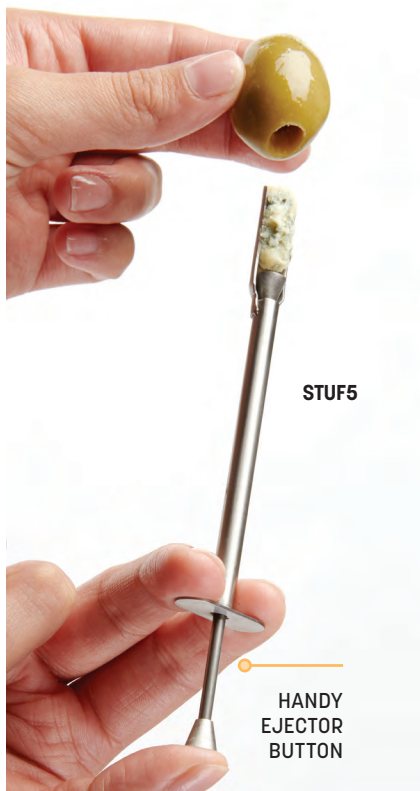

STUF5

HANDY
EJECTOR
BUTTON



M888

M1010

Olive Stuffer

This handy tool makes stuffing olives a breeze.

STUF5 5 5/8" L (14.3 cm)

Muddlers

Perfect for crushing fruits and herbs for delicious cocktails. The muddler does all of the work.

Wood

M888 8" L (20.3 cm)

M1010 10" L (25.4 cm)

Stainless Steel

MDLR7 7" L (17.8 cm)

MDLR10 10" L (25.4 cm)



MDLR10

MDLR7



Stainless Steel Tapered Liquor Pourers

Designed to match our supremely stylish bar tweezers and spoons, these tapered pourers add a touch of class to standard-sized liquor bottles. Dishwasher-safe. **Sold in a pack of 12.**

- TPRS** Silver
1 ¼" Dia. x 4 ½" L (3.2 x 11.4 cm)
- TPRB** Black
1 ¼" Dia. x 4 ½" L (3.2 x 11.4 cm)
- TPRG** Gold
1 ¼" Dia. x 4 ½" L (3.2 x 11.4 cm)

Japanese-Style Stainless Steel Jiggers

Upgrade your bar measuring tools with these dishwasher-safe Japanese-Style Jiggers. Available in a variety of dishwasher-safe sleek trendy finishes, each jigger features two different measuring capacities to craft the finest cocktails.

- JG4** Silver
1 oz. x 1 ½ oz. (29.6 x 44.4 mL)
- JG5** Silver
1 oz. x 2 oz. (29.6 x 59.1 mL)
- JGB4** Black
1 oz. x 1 ½ oz. (29.6 x 44.4 mL)
- JGB5** Black
1 oz. x 2 oz. (29.6 x 59.1 mL)
- JGG4** Gold
1 oz. x 1 ½ oz. (29.6 x 44.4 mL)
- JGG5** Gold
1 oz. x 2 oz. (29.6 x 59.1 mL)



Stainless Steel Bar Spoons

A must-have for anywhere mixology is practiced, these sleek and simple weighted-handled spoons look great and make crafting cocktails a cinch. In your choice of finish. Dishwasher-safe.

- BSS12** Silver
12" L (30.5 cm)
- BSB12** Black
12" L (30.5 cm)
- BSG12** Gold
12" L (30.5 cm)

Stainless Steel Bar Tweezers

The ultimate in bar craft, these tweezers are expressly designed for putting the finishing touches on mixological creations. Offset options let you garnish at difficult angles. Dishwasher-safe.

Straight

- TWSB6** Black
6 1/4" L (15.9 cm)
- TWSS6** Silver
6 1/4" L (15.9 cm)
- TWSG6** Gold
6 1/4" L (15.9 cm)

Offset

- TWOB6** Black
6 1/4" L (15.9 cm)
- TWOS6** Silver
6 1/4" L (15.9 cm)
- TWOG6** Gold
6 1/4" L (15.9 cm)

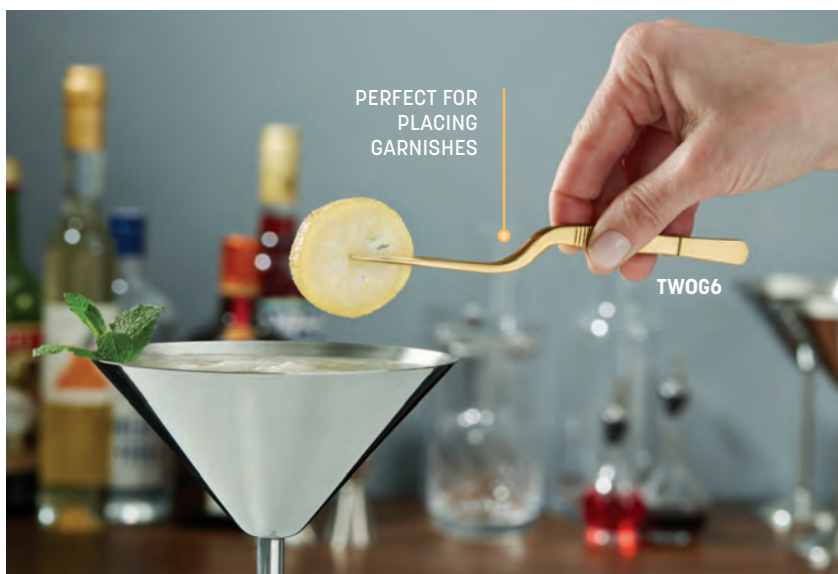



Twisted Bar Spoons

Polished stainless steel with twisted shanks for appearance and durability.

- 510P** No Knob, 10" L (25.4 cm)
- 511P** No Knob, 11" L (27.9 cm) (not shown)
- 510K** Red Knob, 10" L (25.4 cm)
- 511K** Red Knob, 11" L (27.9 cm) (not shown)
- 512K** Red Knob, 12" L (30.5 cm) (not shown)

Trident Bar Forks/Spoons

These stainless steel utensils feature Poseidon's three-pronged trident.

- BS13T** Twisted, 13" L (33 cm)
- BS13P** Plain, 13" L (33 cm)

Bar Knife and Lemon Lime Peeler

Professional tools. Ideal for the bar or the kitchen.

- BK74** Bar Knife, 7 1/4" L (18.4 cm)
- 106** Peeler/Zester, 6" L (15.2 cm)

Ice Picks and Scoops

These ice picks have hardened steel points and wooden handles.

- IC79** Ice Pick
8 3/8" L (21.3 cm)
- IS734** Cast Aluminum Scoop
1/4 cup (59.14 mL)
7 3/4" L x 2 1/8" W (19.7 cm x 5.4 cm)
- IC80** Ice Pick with Heavy Metal
"Ice Breaker" in Handle
8 5/8" L (21.9 cm)
- IS900** Stainless Scoop
1/2 cup (118.3 mL)
9 3/8" L x 3 1/4" W (23.8 x 8.3 cm)



Combination Citrus Squeezer/Bottle Opener

This stainless steel lemon/lime squeezer performs double-duty at the bar.

LSBO 8 1/2" L x 2 1/2" W x 1 1/2" H
(21.6 x 6.4 x 3.8 cm)



Black Finish Squeezer

This heavy-duty metal squeezer with a black lacquered finish features oversized holes for pulp.

LSB3 8 1/2" L x 2 7/8" W x 2 3/8" H
(21.6 x 7.3 x 6 cm)



Bar Strainers

A staple item for every bar, strainers sift out impurities while allowing flavors to mingle in each cocktail. Available in multiple stainless steel options to fit specific crafting requirements. Dishwasher-safe.

JS6 Julep Strainer
NEW 6 1/4" L (15.9 cm)

CS8 Mesh Conical Strainer
NEW 9 1/4" L (23.5 cm)

S208 2-Prong Strainer
5 1/2" L (14 cm)

S209 4-Prong Strainer
5 3/4" L (14.6 cm)



Citrus Squeezer

Stainless steel. Will not rust, tarnish or corrode.

LS206 6 1/2" L x 4 3/4" W x 1 1/2" H
(16.5 x 12.1 x 3.8 cm)

Bar Board

White pressed plastic with non-slip ridges. 1/2" (1.27 cm) thick for longer usage.

BB6105 10" L x 6" W x 1/2" H
(25.4 x 15.2 x 1.3 cm)





Top-Shelf™ Waiter's Corkscrews

Choose from a variety of premium stainless steel corkscrews that are as beautiful as they are functional. All are top-shelf choices.

WCRP Red Pear Wood, Two-Stage
4 ¼" L x 1" W x ½" H
(10.8 x 2.5 x 1.3 cm)

WCMA Mahogany Wood, Two-Stage
5 ¼" L x 1 ¼" W x ½" H
(13.3 x 3.2 x 1.3 cm)

Corkscrews

From a portable plastic corkscrew to stainless steel waiter's corkscrews and a deluxe-finished wing corkscrew, we have the perfect tool for every bottle.

CS7545 Pocket Corkscrew
4 ¼" L (10.8 cm)

WCS871 Waiter's Straight Knife
4 ¼" L x 1" W x ¼" H
(10.8 x 2.5 x 0.6 cm)

WCS867 Waiter's Curved Knife
4 ½" L x 7/8" W x 7/8" H
(11.4 x 2.2 x 2.2 cm)

WCSB415 Waiter's Black Plastic
4 ½" L x 1" W x 7/8" H
(11.4 x 2.5 x 2.2 cm)

CS301 Wing Corkscrew
6 ¼" L x 1 ¾" W
(15.9 x 4.4 cm)

WCS137 Waiter's Stainless Steel
4 ¾" L x 1" W x ¼" H
(11.1 x 2.5 x 0.6 cm)



Stainless Steel Bar Trays and Liners

These bar trays feature a brushed stainless steel lip. Clear mesh liner sold separately.

Trays

SSBT11 11" Dia. (27.9 cm)

SSBT14 14" Dia. (35.6 cm)

Liners

BTTL9 Liner for SSBT11
9 1/2" Dia. (24.1 cm)

BTTL11 Liner for SSBT14
11 3/8" Dia. (29.5 cm)

Double-Wall Hammered Wine Cooler

This stainless steel wine cooler features an elegant hammered design and double walls to keep bottles colder for longer. With a 54 oz. (1.6 L) capacity, it can also serve as a shareable drinking vessel for crowd-pleasing cocktails.

DWWC5 54 oz. (1.6 L)
5 3/4" Dia. x 9 5/8" H
(14.6 x 24.4 cm)



Shown with MGC20 cocktail mixing glass, DWCH7 and DWCH7 martini glasses and STWC6 and STWC6 stainless steel straws



CAN ALSO SERVE AS A SHAREABLE DRINKING VESSEL



Stainless Steel Wine Coolers

Brushed stainless steel coolers are suitable for wine and champagne bottles. Double-wall insulation keeps wine chilled for up to four hours.

SWC48 Straight-Sided
4 ¾" Dia. x 7 ⅝" H (12.1 x 19.4 cm)

HGWC1 Hourglass
5 ¼" Dia. x 8" H (13.3 x 20.3 cm)

SLWC2 Angled
5 ¼" Dia. x 9 ¼" H (13.3 x 23.5 cm)

Top-Shelf Champagne Bucket

This gorgeous double-wall champagne cooler elevates elegance. The high-polished stainless steel design reflects well on any upscale bar service.

DWCC Champagne Cooler
5 ¼" Dia. x 7 ½" H (13.3 x 19.1 cm)

Acrylic Wine Coolers

Double-wall construction provides insulation that keeps chilled wine at proper temperature for up to three hours. Can hold bottles up to 3" (9.52 cm) in diameter.

AWC49 Clear, 5" W x 9" H (12.7 x 23.5 cm)

WCFS462 Silver, 5" W x 9" H (12.7 x 23.5 cm)



Marble Wine Coolers

Coolers keep wine or champagne at proper serving temperature without ice for up to two hours. Color may vary.

MWC57 White, 5" Dia. x 7" H (12.7 x 17.8 cm)

MWC59 Black, 5" Dia. x 7" H (12.7 x 17.8 cm)

Swirl Single-Bottle Wine Cooler

Featuring the same design as the Swirl Wine Bucket, this chiller adds an air of sophistication.

SWSC 4 ½" Dia. x 7 ¼" H (11.4 x 18.4 cm)

Silver-Thread Champagne Bucket and Wine Cooler

So understated and elegant, this double-wall champagne bucket and wine cooler feature brushed stainless steel finishes with polished and etched bases.

SDWW5 Wine Cooler
5 1/2" Dia. x 8 1/2" H (13.3 x 21 cm)

SDWC7 Champagne Bucket
7" Dia. x 7" H (17.8 x 17.8 cm)



Hammered Wine Buckets and Coolers

Choose from classic stainless steel or copper-plated stainless steel.

Stainless Steel

HMWC75 Wine Cooler
4 3/4" Dia. x 7 1/4" H (12.1 x 18.4 cm)

WB9 Champagne Bucket
9 3/8" L x 8" W x 8 3/8" H (23.8 x 20.3 x 21.3 cm)

Copper-Plated

SW4C Wine Cooler
4 3/4" Dia. x 7 1/4" H (12.1 x 18.4 cm)

WB8C Champagne Bucket
9 3/8" L x 8" W x 8 3/8" H (23.8 x 20.3 x 21.3 cm)



Terra Ceramic Buckets and Coolers

These unique beverage buckets are a memorable way to chill wine or upgrade juice dispensers. Inspired by birch and cement, both styles evoke a surprising material to elevate your beverage service.

Black

CWB5 Wine Cooler
5" Dia. x 7 1/8" H (12.7 x 18.1 cm)

CCB7 Champagne Bucket
7 3/8" Dia. x 8" H (18.7 x 20.3 cm)

White

CWW5 Wine Cooler
5" Dia. x 7 1/8" H (12.7 x 18.1 cm)

CCW7 Champagne Bucket
7 3/8" Dia. x 8" H (18.7 x 20.3 cm)





BTS12 shown with DWBT15

BTS16 shown with DWBT185

USE WITH DOUBLE-WALL PARTY TUBS ON PG. 353

Beverage Tub Stands

Our Hammered Double-Wall Party Tubs are impressive on their own. Elevate them with these stands and you'll have a serious showpiece on your hands. Each size features a wide foot for extra stability.

- BTS12** Holds DWBT15
12 1/4" Dia. x 23 5/8" H (31.1 x 60 cm)
- BTS16** Holds DWBT185
16" Dia. x 25" H (40.6 x 63.5 cm)

Champagne Service HOT

Choose from our hammered stainless steel wine bucket or our stainless steel champagne bucket and pair it with one of three stands.

- CHB32** Champagne Bucket Only
8 qt. (7.6 L)
8 3/4" Dia. x 10 1/2" H (22.2 x 26.7 cm)
- CS31** Champagne Stand Only
28" H (71.1 cm)
- CBS33** Champagne Bucket and Stand
8 qt. (7.6 L)
8 3/4" Dia. x 10 1/2" H Bucket
30 1/2" H (77.5 cm) with Stand
(22.2 x 26.7 cm)
- WB9** Hammered Stainless Steel Bucket
5 qt. (4.7 L)
8" Dia. x 8 1/2" H (20.3 x 21.6 cm)
- WICS34** Ironworks Stand
8" Dia. x 32 1/4" H (20.3 x 81.9 cm)
- WBS24** Stand
6 3/8" Dia. x 23 1/2" H (16.2 x 59.7 cm)



HOT

Martini Wine Stand

Bottle service goes meta with this clever stainless steel creation. It's also a dramatic way to serve chilled appetizers or desserts.

- WBSM42** 9 qt. (8.5 L)
14 3/4" Dia. x 31 1/2" H x 8 1/2" Deep
(37.5 x 80 x 21.6 cm)



WBSM42

Swirl Wine Bucket and Stand

The embossed swirl design on this double-wall bucket fits seamlessly into the most sophisticated settings.

SWB Champagne Bucket, 5 qt. (4.7 L)
8 3/4" Dia. x 8 5/8" H (22.9 x 21.9 cm)

SWBSTND Stand
6 1/4" Dia. x 24" H (15.9 x 61 cm)

Hammered Wine Bucket and Stand

This beautiful double-wall stainless steel wine bucket is a knockout on its own. Pair it with the matching stand for a tall, slender floor presentation.

HMWB Champagne Bucket, 5 qt. (4.7 L)
8 3/4" Dia. x 8 5/8" H (22.9 x 21.9 cm)

HMWBSTND Stand
6 1/4" Dia. x 24" H (15.6 x 61 cm)

Wine Coasters

Choose from a shiny hammered design or a straight-brushed satin finish on these double-wall coasters. Each performs double duty as great little snack servers too.

Silver

SW4 4 3/4" Dia. x 2 1/2" H (12.1 x 6.4 cm)

DWBH4 4 3/4" Dia. x 2 1/2" H (12.1 x 6.4 cm)

Gold

GW4 4 3/4" Dia. x 2 1/2" H (12.1 x 6.4 cm)

GHW4 4 3/4" Dia. x 2 1/2" H (12.1 x 6.4 cm)

Oval Wine Bucket Stand

This hammered stainless steel bucket fits two wine or champagne bottles. Use the bucket on a tabletop or pair it with the stand for a perfect fit.

O2BWB 2-Bottle Wine Bucket, 7 qt. (6.6 L)
8 3/8" L x 10 5/8" W x 9" H
(21.3 x 27 x 22.9 cm)

OWBS Stand
24 1/4" H (61.6 cm)



SWB, SWBSTND
sold separately



HMWBSTND
stand

SWB
bucket

SWBSTND
stand

OWBS Stand
24 1/4" H (61.6 cm)

DOUBLE-WALL CONSTRUCTION
ELIMINATES CONDENSATION



SW4

DWBH4



GHW4

GW4



O2BWB
bucket

OWBS
stand



Hammered Aluminum Beverage Tubs and Trays

Add a bit of charm to any occasion—from your next brunch buffet to a private table service for two. Available in a variety of sizes, our Hammered Aluminum Beverage Tubs and Trays come in multiple beautiful finishes for a striking look wherever they're placed.

Copper

- ATHC16** Tray, 16" Dia. x 2 ¾" H
(40.6 x 6.9 cm)
- ATHC9** Tub, 7 ¾ qt. (7.3 L)
12 ¼" L x 9" W x 8 ¾" H
(31.1 x 22.8 x 22.2 cm)
- ATHC10** Tub, 10 qt. (9.4 L)
15" L x 10 ¾" W x 7 ¼" H
(38.1 x 27.3 x 18.4 cm)
- ATHC14** Tub, 16 ¼ qt. (15.3 L)
19" L x 14" W x 8 ¼" H
(48.2 x 35.5 x 20.9 cm)

Gold

- ATHG16** Tray, 16" Dia. x 2 ¾" H
(40.6 x 6.9 cm)
- ATHG9** Tub, 7 ¾ qt. (7.3 L)
12 ¼" L x 9" W x 8 ¾" H
(31.1 x 22.8 x 22.2 cm)
- ATHG10** Tub, 10 qt. (9.4 L)
15" L x 10 ¾" W x 7 ¼" H
(38.1 x 27.3 x 18.4 cm)
- ATHG14** Tub, 16 ¼ qt. (15.3 L)
19" L x 14" W x 8 ¼" H
(48.2 x 35.5 x 20.9 cm)

Silver

- ATHS16** Tray, 16" Dia. x 2 ¾" H
(40.6 x 6.9 cm)
- ATHS9** Tub, 7 ¾ qt. (7.3 L)
12 ¼" L x 9" W x 8 ¾" H
(31.1 x 22.8 x 22.2 cm)
- ATHS10** Tub, 10 qt. (9.4 L)
15" L x 10 ¾" W x 7 ¼" H
(38.1 x 27.3 x 18.4 cm)
- ATHS14** Tub, 16 ¼ qt. (15.3 L)
19" L x 14" W x 8 ¼" H
(48.2 x 35.5 x 20.9 cm)

Black

- ATHB16** Tray, 16" Dia. x 2 ¾" H
(40.6 x 6.9 cm)
- ATHB9** Tub, 7 ¾ qt. (7.3 L)
12 ¼" L x 9" W x 8 ¾" H
(31.1 x 22.8 x 22.2 cm)
- ATHB10** Tub, 10 qt. (9.4 L)
15" L x 10 ¾" W x 7 ¼" H
(38.1 x 27.3 x 18.4 cm)
- ATHB14** Tub, 16 ¼ qt. (15.3 L)
19" L x 14" W x 8 ¼" H
(48.2 x 35.5 x 20.9 cm)





Square Hammered Tubs

These dishwasher-safe hammered stainless steel tubs are perfect for the most elegant events.

- STH6** 1 3/8 qt. (1.3 L)
6" Sq. x 3 1/4" H
(15.2 x 8.3 cm)
- STH8** 6 1/4 qt. (5.9 L)
8" Sq. x 7 1/4" H
(20.3 x 18.4 cm)
- STH14** 22 1/2 qt. (21.3 L)
14" Sq. x 8 1/2" H
(35.6 x 21.6 cm)
- STH16** 32 1/2 qt. (30.8 L)
16 1/2" Sq. x 9 1/2" H
(41.9 x 24.1 cm)

Angled Hammered Tubs

In three sizes, these upscale stainless steel tubs are perfect for table service of wine or beer on ice.

- HMSR6** 2 qt. (1.9 L)
6" Dia. x 7 1/2" H
(15.2 x 43.7 cm)
- HMSR7** 3 qt. (2.8 L)
7" Dia. x 8 1/2" H
(17.8 x 21.6 cm)
- HMSR8** 5 qt. (4.7 L)
8" Dia. x 9 1/2" H
(20.3 x 24.1 cm)



Double-Wall Hammered Bottle Chillers

These sensational stainless steel chillers spark a dramatic look wherever they're placed. Keep bottles chilled for up to four hours.

- DWWC1** 1-Bottle Chiller
5 1/4" Sq. x 8" H
(13.3 x 20.3 cm)
- DWWC2** 2-Bottle Chiller
10" L x 6 3/4" W x 8" H
(25.4 x 17.1 x 20.3 cm)
- DWWC4** 4-Bottle Chiller
18 1/2" L x 6 3/4" W x 8" H
(47 x 17.1 x 20.3 cm)



Shown with
FRY375 basket

Party Tubs

Stainless Steel

A dual satin and mirror finish dresses up this tub.

STUB20 25 qt. (24 L)
20 1/8" L x 15" W x 11 1/8" H
(51.1 x 38.1 x 28.3 cm)

Galvanized

Hand-wash only. Not for use with acidic foods.

GPTUB20 25 qt. (24 L)
20" L x 15" W x 11" H
(50.8 x 38.1 x 27.9 cm)

Hammered Party Tub

Manufactured from heavy-duty stainless steel, our big party tub is individually crafted with a ball-peen hammer.

HMDOB19149 25 qt. (24 L)
19 1/8" L x 14 1/2" W x 9" H
(48.6 x 35.6 x 23.5 cm)

Double-Wall Party Tubs HOT

These stainless steel tubs feature a mirror finish on the outside with a hammered accent band that runs around the middle. Inside is brushed stainless steel. Free-swinging decorative handles round out the look.

DWBT15 15 qt. (14.6 L)
15" Dia. x 7" H (38.1 x 17.8 cm)

DWBT185 29 qt. (27.8 L)
18 1/2" Dia. x 9" H (47 x 22.9 cm)

Punch Bowls

Stainless steel and an elegant profile deliver a one-two punch for large group beverage service.

Hammered

HMPB12 8 qt. (7.6 L)
17" Dia. x 10 7/8" H
(43.2 x 27.6 cm)

HMPB20 13 qt. (12.3 L)
18 1/2" Dia. x 12" H
(47 x 30.5 cm)

Allegro

ALLEGPBWL15 14 qt. (13.2 L)
18 5/8" Dia. x 10 1/8" H
(47.3 x 25.7 cm)



CHECK OUT PARTY TUB STANDS ON PG. 348

HOT



THESE STAINLESS STEEL PUNCH BOWLS ARE A REAL KNOCKOUT



ISSB4

ISSB4, ISSB6,
DWIB40
ICE BUCKETS
HAVE GRATING
INSIDE



DWIB40

Top-Shelf Double-Wall Ice Bucket with Ice Tongs

Featuring a high-polished mirror finish, this stainless steel bucket comes with ice tongs and removable grating in the base for drainage.

DWIB40 40 oz. (1.2 L)
5 7/8" Dia. x 7 1/2" H
(14.9 x 19.1 cm)

Satin Finish Double-Wall Ice Buckets with Ice Tongs

These little stainless steel ice buckets come in unique contemporary styles and are perfect for tableside service. Double-wall design keeps ice cooler longer. The ISSB4 and ISSB6 feature a removable grating in the base to drain water.

ISSB4 34 oz. (1 L)
4 3/8" Dia. x 6 1/4" H
(11.1 x 15.9 cm)

ISSB6 34 oz. (1 L)
4 7/8" Dia. x 6 3/8" H
(12.4 x 16.2 cm)

ISSB8 49 oz. (1.5 L)
4 3/8" Dia. x 8 1/4" H
(11.1 x 21 cm)



ISSB6

ISSB8

Plastic Condiment Holder

Use this plastic container at the beverage bar, taco bar, omelette station or anywhere else! Features an easy-swing hinged lid and 1 1/2" (3.8 cm) deep storage base for ice.

FCS16 4-Compartment, 22 oz. (650.6 mL)
16" L x 6 1/4" W x 5 1/4" H
(40.6 x 15.9 x 13.3 cm)

Replacement Insert

RC5 22 oz. (650.6 mL) (not shown)
5 3/4" L x 3 5/8" W x 2 3/4" H
(14.6 x 9.2 x 7 cm)

Stainless Steel Condiment Holders

A beautiful stainless steel finish sparkles on these condiment holders. Four, five or six compartments are perfect for keeping all of your garnishes in one place. The sanitary plastic containers fit inside, and a clear, plastic-hinged cover seals in freshness. 16 oz. (473.2 mL) plastic containers.

Hammered Finish

HMCD4 4-Compartment
12" L x 5 3/4" W x 3 1/2" H
(30.5 x 14.6 x 8.9 cm)
(not shown)

HMCD5 5-Compartment
14 3/4" L x 5 3/4" W x 3 1/2" H
(37.5 x 14.6 x 8.9 cm)
(not shown)

HMCD6 6-Compartment
17 3/4" L x 5 3/4" W x 3 1/2" H
(45.1 x 14.6 x 8.9 cm)

Satin Finish

CD4 4-Compartment
12" L x 5 3/4" W x 3 1/2" H
(30.5 x 14.6 x 8.9 cm)
(not shown)

CD5 5-Compartment
14 3/4" L x 5 3/4" W x 3 1/2" H
(37.5 x 14.6 x 8.9 cm)
(not shown)

CD6 6-Compartment
17 3/4" L x 5 3/4" W x 3 1/2" H
(45.1 x 14.6 x 8.9 cm)

Black Finish

CDB4 4-Compartment
12" L x 5 3/4" W x 3 1/2" H
(30.5 x 14.6 x 8.9 cm)
(not shown)

CDB5 5-Compartment
14 3/4" L x 5 3/4" W x 3 1/2" H
(37.5 x 14.6 x 8.9 cm)
(not shown)

CDB6 6-Compartment
17 3/4" L x 5 3/4" W x 3 1/2" H
(45.1 x 14.6 x 8.9 cm)

Replacement Insert

PCI10 Plastic Insert for HMCD4, HMCD5, HMCD6, CD4, CD5, CD6, CDB4, CDB5, CDB6
16 oz. (473.2 mL)





BARB7

BARB5



BAR6

Plastic Bar Caddy

Black plastic six-compartment organizer.

BAR6 Black
 9 1/2" L x 5 3/4" W x 4 1/8" H
 (24.1 x 14.6 x 10.5 cm)

Bar Caddies

Colorful bar accessories really "pop" in these metal caddies.

BARB5 Black Finish
 8" L x 4" W x 4 1/8" H
 (20.3 x 10.2 x 10.5 cm)

BARB7 Black Finish
 9 1/8" L x 5 7/8" W x 4 1/8" H
 (23.2 x 14.9 x 10.5 cm)

BARB7 Satin Finish
 9 1/8" L x 5 7/8" W x 4 1/8" H
 (23.2 x 14.9 x 10.5 cm)

HMBAR8 Hammered Finish
 9 1/8" L x 5 7/8" W x 4 1/8" H
 (23.2 x 14.9 x 10.5 cm)

BARC7 Antique Copper Finish
 9 1/8" L x 5 7/8" W x 4 1/8" H
 (23.2 x 14.9 x 10.5 cm)



HMBAR8

BARB7



BARC7

Bottle Stoppers

Stop fizz and flavor from escaping with these plastic bottle stoppers. **Sold in a pack of 3.**

EBSS312 Bottle Stoppers

Measured Pourers

Take the guesswork out of cocktail preparation with these colorful measured pourers.

PR78921 Black Base, 5/8 oz. (18.5 mL)

PR78922 Green Base, 3/4 oz. (22.2 mL)

PR78923 Blue Base, 7/8 oz. (25.9 mL)

PR78924 Red Base, 1 oz. (29.6 mL)

PR78925 Brown Base, 1 1/8 oz. (33.3 mL)

PR78926 Clear Base, 1 1/4 oz. (37 mL)

PR78927 Yellow Base, 1 1/2 oz. (44.4 mL)

PR78928 White Base, 2 oz. (59.1 mL)

Champagne Bottle Stopper

This stainless steel stopper with high-gloss finish keeps champagne bubbly for up to two days.

CHBST112 Champagne Bottle Stopper



 **WARNING:** This product can expose you to chemicals including Bisphenol A (BPA), which is known to the State of California to cause birth defects or other reproductive harm. For more information, go to www.P65warnings.ca.gov. Warning applies to State of California only.



NOT FOR SALE IN
NEW ZEALAND
OR ON MARS
(SERIOUSLY)

LB027

SBO154

BBC39



CAB45



Bottle and Can Openers

Heavy-gauge tempered stainless steel. Deluxe opener has a hardwood handle.

BBC39 Deluxe Bottle/Can Opener
4 ½" L (11.4 cm)

CAB45 Bottle/Can Opener (Pack of 2)
4 ½" L (11.4 cm)

Flat Bottle Openers

Slim, low-profile stainless steel design slips easily into pockets for convenient service.

SBO154 Mini
4 ¼" L (10.8 cm)

LB027 Large
7" L (17.8 cm)

Cap Catcher and Wall Bottle Opener

Handy accessories for bars. Opener packed with mounting screws.

WB03 Bottle Opener
3 ⅞" L x 2" W (5.1 x 9.8 cm)

CC40 Cap Catcher
10 ⅛" L x 5 ¼" W (25.7 x 13.3 cm)

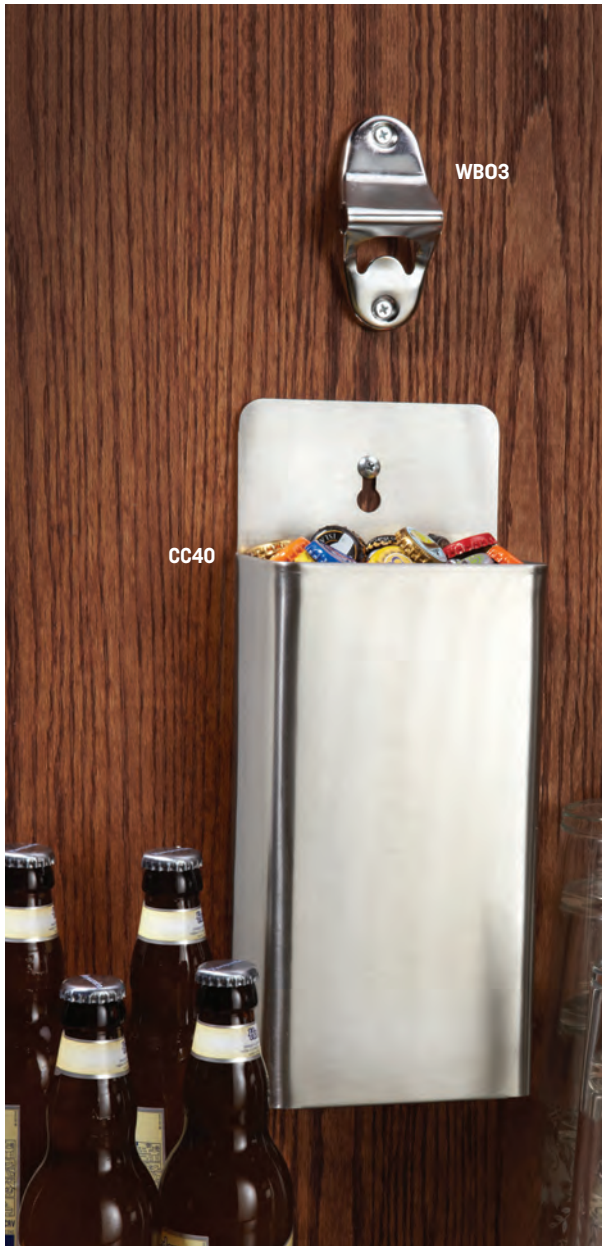

WB03

CC40

Margarita Rimmer

This black plastic margarita rimmer features three compartments: one with a sponge to hold lime juice, one for salt and one for sugar.

MGR3 Three-Compartment Rimmer

MGRSP3 Replacement Sponge for MGR3 (not shown)



MGR3



BLACKBM1218 shown with S208 strainer

ALSO AVAILABLE IN BROWN

Service Mat HOT

One-piece rubber construction. 18" L x 12" W (45.7 x 30.5 cm).

BROWNBM1218 Brown (not shown)

BLACKBM1218 Black

Deluxe Bar Mat

One-piece rubber construction. 27" L x 3 1/4" W (68.6 x 8.3).

BM23 Brown

BLM24 Black



BLM24 shown with J205 jigger

BM23

Bar Tile !

These 12" square (30.5 cm) molded vinyl tiles snap together. Textured surface prevents slippage, and feet improve drainage and air circulation.

BT12X12 Black

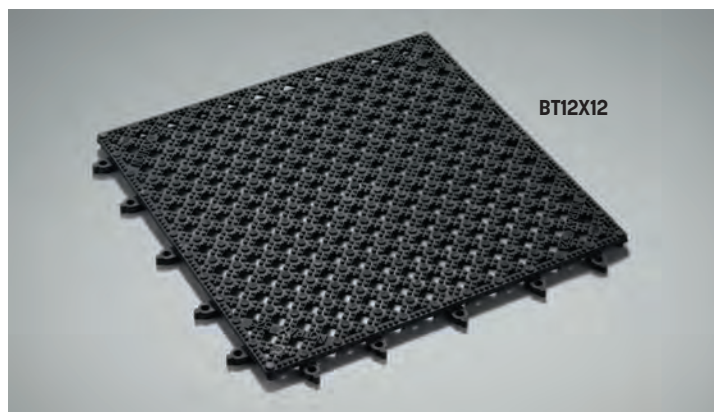

BT12X12

Bar Tray Mat

Round black non-slip mat fits bar trays.

BTTL13 13" Dia. (33 cm)

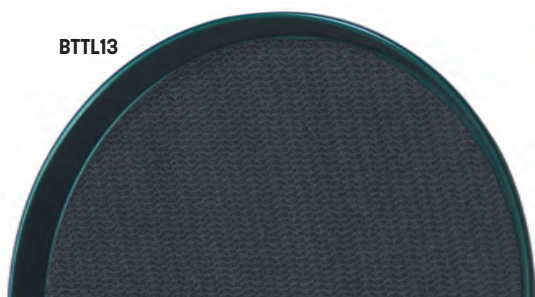

BTTL13



WARNING: This product can expose you to chemicals including Di(2-ethylhexyl)phthalate (DEHP) & Diisononyl Phthalate (DINP), which are known to the State of California to cause birth defects or other reproductive harm. For more information, go to <http://www.P65warnings.ca.gov>. Warning applies to State of California only.



GR1435

AVAILABLE IN TWO COLORS:
WALNUT AND ESPRESSO



USA

524ST

913ST

OFP7

699ST

OFP11

Glass Racks

A wide variety of glasses easily slip in and out of rack ends. Easy to assemble and hang. 35" L x 14" W x 1 1/2" H (88.9 x 35.6 x 3.8 cm).

GR1435 Walnut

RG5341 Espresso
(not shown)

Strainer Funnels

Spun aluminum with a built-in strainer. Makes disposing of accumulated debris easy. Fits standard bar overflow pipes, including our OFP7 and OFP11 models.

524ST 16-gauge Aluminum
1 pint (473 mL)
1.25 mm

699ST 16-gauge Aluminum
1 qt. (946 mL)
1.25 mm

913ST 16-gauge Aluminum
2 qt. (1.9 L)
1.25 mm

Free-flow funnels are listed on pg. 374.

Overflow Pipes

Plastic pipes set in rubber bushings to fit both 1" and 1 1/2" drains. Ideal companions for our strainer funnels.

OFP7 7" H (17.78 cm)

OFP11 11" H (27.94 cm)

Kitchen Supplies





DEVELOPS NON-STICK
QUALITIES OVER TIME



BSFP8

BSFP10

BSFP11

BSFP12

Fry Pans

In black or carbon steel, these non-coated fry pans tolerate high heat, making them safe for induction, oven and broiler.

Black Steel

- BSFP8** 8" Dia. (20.3 cm)
13" L (33 cm) Overall
- BSFP10** 10" Dia. (25.4 cm)
16" L (40.6 cm) Overall
- BSFP11** 11" Dia. (27.9 cm)
20" L (50.8 cm) Overall
- BSFP12** 12" Dia. (30.5 cm)
22" L (55.9 cm) Overall

Carbon Steel

- CSFP8** 8" Dia. (20.3 cm)
13" L (33 cm) Overall
- CSFP10** 10" Dia. (25.4 cm)
16" L (40.6 cm) Overall
- CSFP11** 11" Dia. (27.9 cm)
20" L (50.8 cm) Overall
- CSFP12** 12" Dia. (30.5 cm)
22" L (55.9 cm) Overall

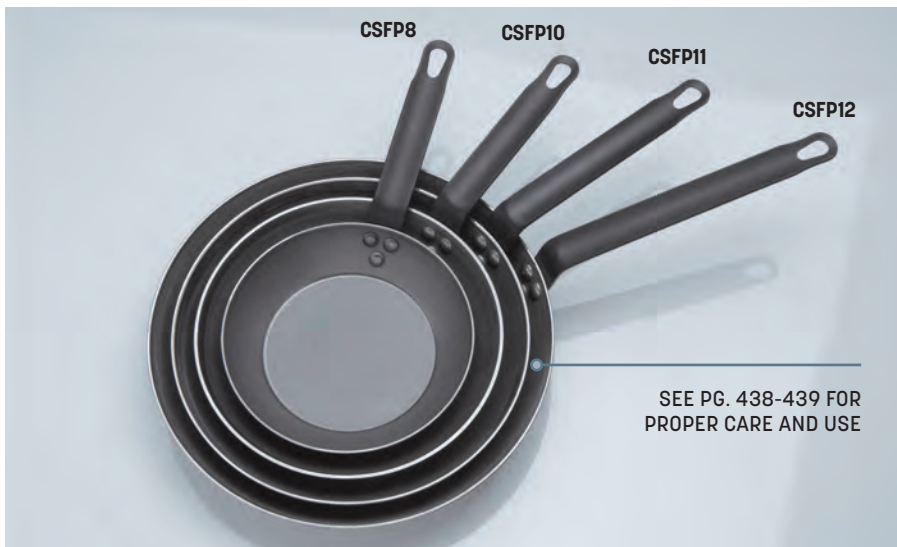

CSFP8

CSFP10

CSFP11

CSFP12

SEE PG. 438-439 FOR
PROPER CARE AND USE

Piano Whips - Sealed

Featuring stainless steel construction, sanitary sealed handles and flexible wire, these are perfect for whisking delicate sauces and batters.

PW10	10" L (25.4 cm)
PW12	12" L (30.5 cm)
PW14	14" L (35.6 cm)
PW16	16" L (40.6 cm)
PW18	18" L (45.7 cm)

One-Piece Ladles

All-purpose stainless steel ladles featuring heavy-gauge construction. Sizes are clearly marked for ease of use.

L11005	½ oz. (14.8 mL) 11" (27.8 cm) Handle
L1101	1 oz. (29.6 mL) 10 ½" (26.7 cm) Handle
L11015	1 ½ oz. (44.4 mL) 10 ¾" (27.3 cm) Handle
L1102	2 oz. (59.1 mL) 10 ¾" (27.3 cm) Handle
L1103	3 oz. (88.7 mL) 11 ¾" (29.8 cm) Handle
L1104	4 oz. (118.3 mL) 14" (35.6 cm) Handle
L1105	5 oz. (147.8 mL) 12 ½" (31.8 cm) Handle
L1106	6 oz. (177.4 mL) 12 ¾" (32.4 cm) Handle
L1107	7 oz. (207 mL) 12 ½" (31.8 cm) Handle
L1108	8 oz. (236.6 mL) 12 ¾" (31.1 cm) Handle (not shown)
L1112	12 oz. (354.8 mL) 12 ¾" (32.4 cm) Handle (not shown)

Two-Piece Syrup Ladles

Stainless steel two-piece welded ladles stand up to sticky syrup, fudge, fruit and gravy.

L210	1 oz. (29.6 mL) 7" (17.8 cm) Handle
L215	1 ½ oz. (44 mL) 7" (17.8 cm) Handle
L220	2 oz. (59.1 mL) 7" (17.8 cm) Handle

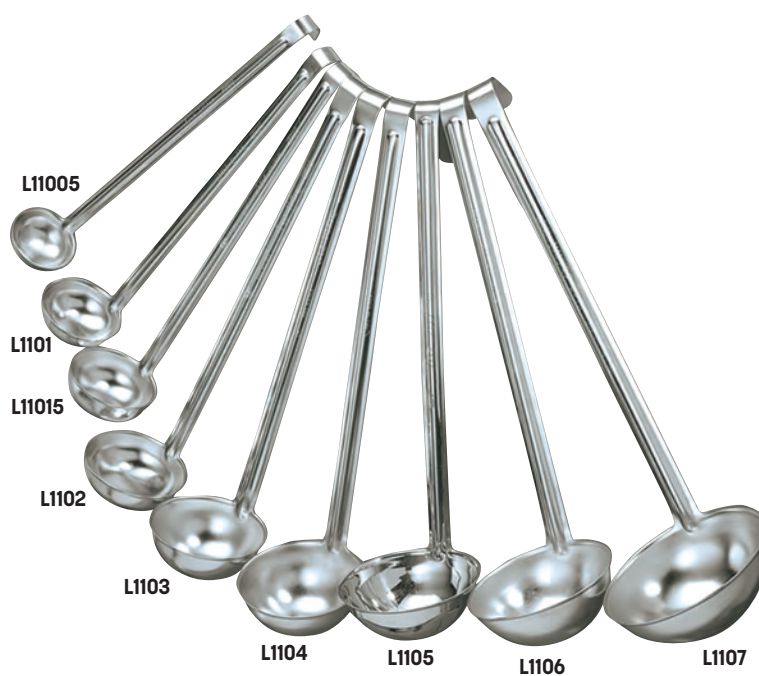
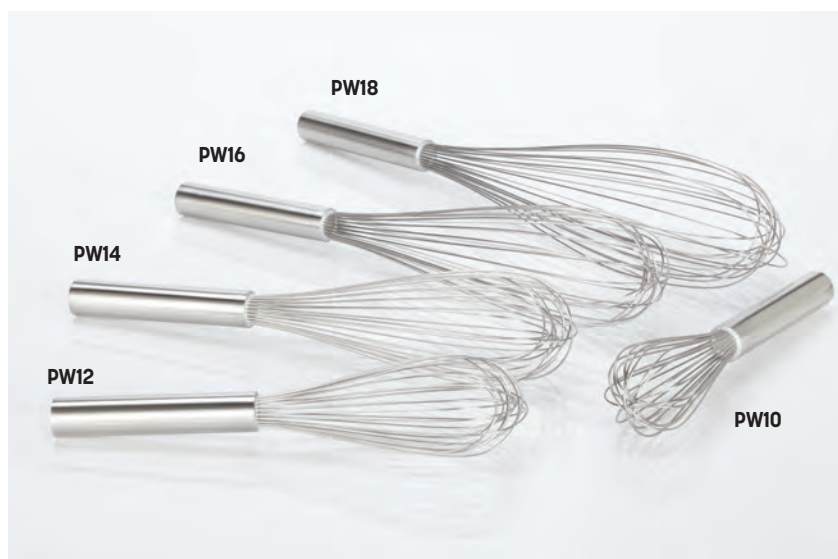

Bakelite Handle Spoons

Stainless steel spoons with Bakelite handles. Comes in three differently styled bowls. 13" L (33 cm) overall.

132SL Slotted Bowl

130SO Solid Bowl

131PE Perforated Bowl

Spooners

One-piece stainless steel construction. Choose between solid and perforated bowls. Featuring color-coded Bakelite 10 3/4" (27.3 cm) grip handles.

Solid Bowl

SPN2 Red, 2 oz. (59.1 mL)
2 1/2" Dia. (6.4 cm)

SPN3 Beige, 3 oz. (88.7 mL)
3" Dia. (7.6 cm)

SPN4 Green, 4 oz. (118.3 mL)
3 3/8" Dia. (8.6 cm)

SPN5 Yellow, 5 oz. (147.8 mL)
3 1/2" Dia. (8.9 cm)

SPN6 Black, 6 oz. (177.4 mL)
3 3/4" Dia. (9.5 cm)

SPN8 Blue, 8 oz. (236.6 mL)
4" Dia. (10.2 cm)

Perforated Bowl

SPNP2 Red, 2 oz. (59.1 mL)
2 1/2" Dia. (6.4 cm)

SPNP3 Beige, 3 oz. (88.7 mL)
3" Dia. (7.6 cm)

SPNP4 Green, 4 oz. (118.3 mL)
3 3/8" Dia. (8.6 cm)

SPNP5 Yellow, 5 oz. (147.8 mL)
3 1/2" Dia. (8.9 cm)

SPNP6 Black, 6 oz. (177.4 mL)
3 3/4" Dia. (9.5 cm)

SPNP8 Blue, 8 oz. (236.6 mL)
4" Dia. (10.2 cm)





Wire-Handled Measuring Cups

Long-Handled

These stainless steel measuring cups feature extra-long handles to minimize hand-to-food contact. Sold individually.

MCL14	¼-Cup (59.1 mL) 8 ⅞" L (20.6 cm) Overall
MCL13	⅓-Cup (78.9 mL) 8 ½" L (21.6 cm) Overall
MCL12	½-Cup (118.3 mL) 8 ⅞" L (22.5 cm) Overall
MCL75	¾-Cup (177.4 mL) 9 ¼" L (23.5 cm) Overall
MCL10	1 Cup (236.6 mL) 9 ⅞" L (23.2 cm) Overall
MCL125	1 ¼-Cup (295.7 mL) 9 ¾" L (24.8 cm) Overall
MCL150	1 ½-Cup (354.9 mL) 9 ⅝" L (24.4 cm) Overall
MCL175	1 ¾-Cup (414 mL) 10" L (25.4 cm) Overall
MCL200	2 Cup (473.2 mL) 10 ¼" L (26 cm) Overall

Short-Handled

MCW4	Set of 4 ¼-Cup (59.1 mL), ⅓-Cup (78.9 mL), ½-Cup (118.3 mL) and 1 Cup (236.6 mL)
MCW14	¼-Cup (59.1 mL) 5 ⅜" L (13.7 cm) Overall
MCW13	⅓-Cup (78.9 mL) 5 ⅝" L (14.3 cm) Overall
MCW12	½-Cup (118.3 mL) 5 ⅞" L (14.9 cm) Overall
MCW75	¾-Cup (177.4 mL) 6 ⅞" L (15.6 cm) Overall
MCW10	1 Cup (236.6 mL) 6 ½" L (16.5 cm) Overall
MCW125	1 ¼-Cup (295.7 mL) 7 ¼" L (18.4 cm) Overall
MCW150	1 ½-Cup (354.9 mL) 7 ½" L (19.1 cm) Overall
MCW175	1 ¾-Cup (414 mL) 8 ⅞" L (20.6 cm) Overall
MCW200	2 Cup (473.2 mL) 8 ⅞" L (21.6 cm) Overall

Flat-Handled Measuring Cup Set

MCL4	Set of 4 ¼-Cup (59.1 mL), ⅓-Cup (78.9 mL), ½-Cup (118.3 mL) and 1 Cup (236.6 mL)
-------------	--

Stainless Steel Measuring Spoon Sets

Comes in three different stylish designs. Sets of four held together with O-rings.

MSSS73 1 Tablespoon (14.8 mL), 1 Teaspoon (4.9 mL), ½ Teaspoon (2.5 mL), ¼ Teaspoon (1.2 mL)

MSSR74 1 Tablespoon (14.8 mL), 1 Teaspoon (4.9 mL), ½ Teaspoon (2.5 mL), ¼ Teaspoon (1.2 mL)

MSSF75 1 Tablespoon (14.8 mL), ½ Tablespoon (7.4 mL), 1 Teaspoon (4.9 mL), ½ Teaspoon (2.5 mL)



Dredge

Made of durable plastic, this transparent dredge is dishwasher-safe, as well as stain and odor-resistant. Holds 10 oz. (295 mL). Each unit is shipped with a coarse, medium and fine lid.

10SD Dredge with 3 Tops
4" L x 3" W x 3 ¾" H
(10.2 x 7.6 x 9.5 cm)

Replacement Dredge Lids

T10SDC Coarse Top
3 ½" Dia. x ¾" H
(7.9 x 0.9 cm)

T10SDM Medium Top
3 ½" Dia. x ¾" H
(7.9 x 0.9 cm)

T10SDF Fine Top
3 ½" Dia. x ¾" H
(7.9 x 0.9 cm)



Hand-Crank Cheese Graters

Choose between two easy-to-use graters. The plastic model comes with interchangeable stainless steel cylinders for thin strips, medium grating or fine grating. The stylish stainless steel model comes with one cylinder.

PCG9 Plastic
7 ¾" L x 2 ⅝" W x 3 ½" H
(19.7 x 6.7 x 8.9 cm)

SCG8 Stainless Steel
8 ⅝" L x 3 ⅝" W x 2 ⅞" H
(21.9 x 9.2 x 7.3 cm)



China Cap Strainers

Heavy-gauge stainless steel with permanently welded handle, band and clip. Comes in your choice of cone and perforation sizes.

Fine - 1/16" (1.59 mm) Perforations

CC10F 10" ID x 10" D x 20" L
(25.4 x 25.4 x 50.8 cm)

CC12F 12" ID x 12" D x 22" L
(30.5 x 30.5 x 55.9 cm)

Coarse - 3/32" (2.38 mm) Perforations

CC10C 10" ID x 10" D x 20" L
(25.4 x 25.4 x 50.8 cm)

CC12C 12" ID x 12" D x 22" L
(30.5 x 30.5 x 55.9 cm)





French Fry Scoops

Choose between right-handed or ambidextrous use. Crafted from stainless steel with plastic handles to protect hands from heat.

- FFSR1** Right Handle
8 7/8" L x 8 1/2" W x 2 1/2" H
(22.5 x 21.6 x 6.4 cm)
- FFSD3** Dual Handle
8 7/8" L x 8 1/2" W x 2 1/2" H
(22.5 x 21.6 x 6.4 cm)
- FFHANDLE** Replacement Handle
4 1/4" L x 1 1/8" W x 1" H
(10.8 x 2.9 x 2.5 cm)



Aluminum Scoops

Heavy-duty all-purpose scoops crafted from brightly finished cast aluminum with easy-grip handles.

- ASC5** 5 oz. (147.9 mL)
5" L x 2 3/8" W Bowl (12.7 x 6 cm)
- ASC12** 12 oz. (354.8 mL)
6 1/4" L x 3 1/8" W Bowl (15.9 x 7.9 cm)
- ASC24** 24 oz. (709.7 mL)
7" L x 3 3/8" W Bowl (17.8 x 9.8 cm)
- ASC38** 38 oz. (1.12 L)
9" L x 4 5/8" W Bowl (22.9 x 11.7 cm)
- ASC58** 58 oz. (1.72 L)
10" L x 5 1/2" W Bowl (25.4 x 14 cm)
- ASC84** 84 oz. (2.49 L)
12" L x 6 1/4" W Bowl (30.5 x 15.9 cm)

Cedar Planks

Create smoky flavor the classic way. Simply soak the planks in water, add fish, appetizers or veggies and fire up the grill. **Sold in a pack of 12.**

- CWP7** 6 1/2" L x 3 1/2" W x 1/4" H
(16.5 x 8.9 x 0.6 cm)
- CWP8** 8" L x 5 1/2" W x 1/4" H
(20.3 x 14 x 0.6 cm)
- CWP12** 11 7/8" L x 5 1/2" W x 1/4" H
(30.2 x 14 x 0.6 cm)



ADD SMOKY FLAVOR TO GRILLED FOODS

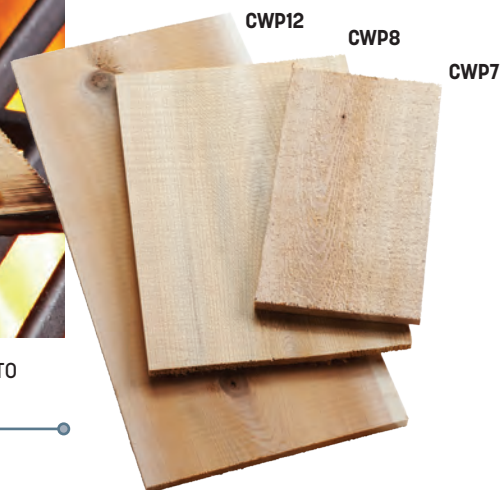

Bowl Scraper/Dough Scraper/ Cake Decorator

A versatile tool made from durable hard plastic. ¼" hole (6 mm).

BS64 5 ⅝" L x 3 ¾" W
(14.3 x 9.5 cm)

Slant-Edge Scrapers

Stainless steel blades with slanted edges and beautiful wooden handles.

SSC17 3" W (7.6 cm) Blade
7 ½" L (19.1 cm) Overall

SSC19 4" W (10.2 cm) Blade
8 ¼" L (21 cm) Overall

SSC18 3" W (7.6 cm) Blade
12" L (30.5 cm) Overall

Heat-Resistant Scrapers

Long cool-touch handles and stain-resistant blades add up to smart, safe kitchen work. Dishwasher-safe and heat resistant up to 500° F (260° C).

PHBS10 2 ¼" W (5.7 cm) Blade
10" L (25.4 cm) Overall

PHBS14 2 ¾" W (7 cm) Blade
14" L (35.6 cm) Overall

PHBS16 2 ¾" W (7 cm) Blade
16" L (40.6 cm) Overall

Dough Cutters and Scrapers

Rounded corners will not gouge, scratch or damage trays.

DS6704 Wood-Handled
4 ½" L (11.4 cm)

DSP6705 Plastic-Handled
4 ½" L (11.4 cm)

DS6706 Wood-Handled
6" L (15.2 cm)





Wood-Handled Turners

Stainless steel offset blades and wood handles. Available with straight or rounded edges.

Giant "Oversize" Turners

- LT20** 8" L x 3" W Blade, 20" L Overall (20.3 x 7.6, 50.8 cm)
- 19008** 8" L x 4" W Blade, 15 3/4" L Overall (20.3 x 10.2, 40 cm)
- LT198** 8" L x 4" W Blade, 20" L Overall (20.3 x 10.2, 50.8 cm)

14" (35.6 cm) Long Overall with 8" Blade

- LT14** Rounded Blade
8" L x 3" W (20.3 x 7.6 cm)
- LT14ST** Straight Blade
8" L x 3" W (20.3 x 7.6 cm)
- LT14P** Rounded Perf Blade
8" L x 3" W (20.3 x 7.6 cm)

12" (30.5 cm) Long Overall with 6" Blade

- LT12** Rounded Blade
6" L x 3" W (15.2 x 7.6 cm)
- LT12ST** Straight Blade
6" L x 3" W (15.2 x 7.6 cm)

Plastic-Handled Turners

Stainless steel offset blades and dark brown plastic handles. Available with straight or rounded edges.

14" (35.6 cm) Long Overall with 8" Blade

- PS14** Rounded Blade
8" L x 3" W (20.3 x 7.6 cm)
- PS14P** Rounded Perf Blade
8" L x 3" W (20.3 x 7.6 cm)

12" (30.5 cm) Long Overall with 6" Blade

- PS12ST** Straight Blade
6" L x 3" W (15.2 x 7.6 cm)
- PS12** Rounded Blade
6" L x 3" W (15.2 x 7.6 cm)

Pressed Wood Servers

Made of NSF- and USDA-listed material, these wood serving utensils offer affordable convenience to any operation.

- MPS12** Spatula
12" L (30.5 cm)
- MPT12** Turner
12" L (30.5 cm)



Wood-Handled Hamburger Turners / Pizza Servers

Stainless steel offset blades with straight edges.

- 19007** 5" L x 3" W Blade, 11 $\frac{5}{8}$ " L Overall
(12.7 x 7.6, 29.5 cm)
- 19075** 6" L x 4" W Blade, 11 $\frac{5}{8}$ " L Overall
(15.2 x 10.2, 29.5 cm)

Heavy-Duty Hamburger Turners / Pizza Servers

Stainless steel offset blades and black plastic handles. Available with straight or rounded edges.

- PS197** 5" L x 3" W Blade, 11 $\frac{5}{8}$ " L Overall
(12.7 x 7.6, 29.5 cm)
- PS19075** 6" L x 4" W Blade, 11 $\frac{5}{8}$ " L Overall
(15.2 x 10.2, 29.5 cm)

Giant "Oversize" Turner

- PS19008** 8" L x 4" W Blade, 15 $\frac{3}{4}$ " L Overall
(20.3 x 10.2, 40 cm)



19007

19075

PS197

PS19075

PS19008

Assorted Servers

Plastic-Handled Turner

Stainless steel offset blade with rounded edges.

- PS10** 3 $\frac{5}{8}$ " L x 1 $\frac{7}{8}$ " W Blade, 10" L Overall
(9.2 x 4.8, 25.4 cm)

Wood-Handled Pie Server/Pizza Server

Stainless steel with a flexible tapered offset blade.

- 19006** 5" L x 2 $\frac{1}{2}$ - 1 $\frac{1}{2}$ " W Blade
10 $\frac{1}{2}$ " L Overall
(12.7 x 6.3 x 3.8, 26.7 cm)

Slotted Fish Spatula

A specially shaped stainless steel blade and polypropylene handle make this an essential for anyone who serves fish.

- PSFSP** 6 $\frac{1}{2}$ " L x 2 $\frac{7}{8}$ " W Blade
11 $\frac{3}{4}$ " L Overall
(16.5 x 7.3, 29.8 cm)

Pie Server/Pizza Server

Stainless steel with a flexible tapered offset blade and dark brown plastic handle.

- PS196** 5" L x 2 $\frac{1}{2}$ - 1 $\frac{1}{2}$ " W Blade
10 $\frac{1}{2}$ " L Overall
(12.7 x 6.3 x 3.8, 26.7 cm)

Deluxe Stainless Steel Server

Straight out of our Buffet & Display section, this beautiful server features a sleek design that works for the back of the house as well as the front.

- SW12PAS** 11" L Server (27.9 cm)



PS10

19006

PSFSP

PS196

SW12PAS

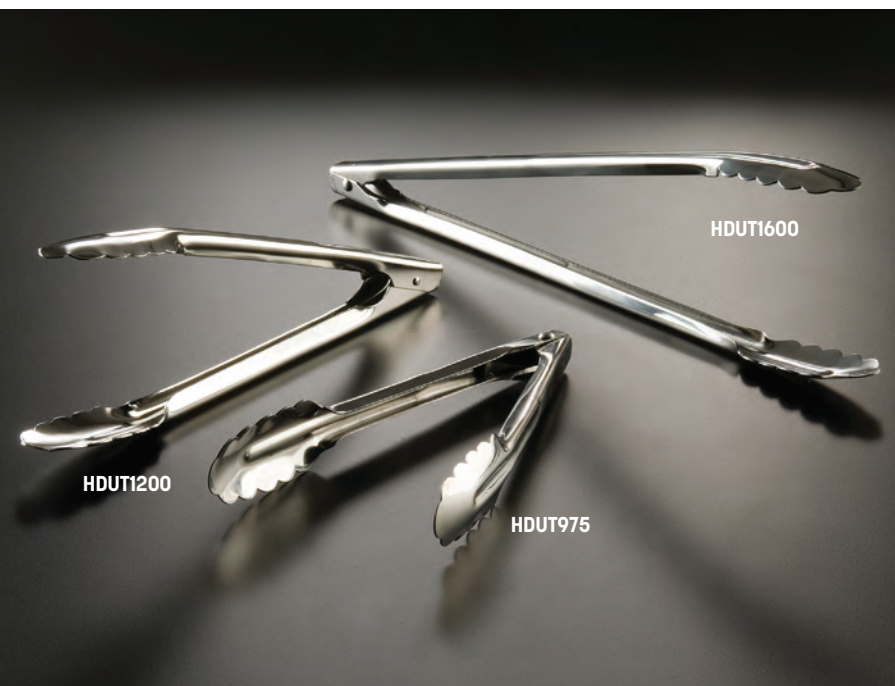

Utility Tongs

Heavy-Weight (not shown)

0.7 mm stainless steel with tempered flat steel springs.

- UT707** 7" L (17.8 cm)
- UT975** 10" L (25.4 cm)
- UT1200** 12" L (30.5 cm)
- UT1600** 16" L (40.6 cm)
- FS911** Replacement Spring

Extra-Heavy Weight

1.2 mm stainless steel with tempered flat steel springs.

- HDUT975** 10" L (25.4 cm)
- HDUT1200** 12" L (30.5 cm)
- HDUT1600** 16" L (40.6 cm) w/ Double Flat Spring
- FS911** Replacement Spring

Heavy-Duty Stainless Steel Pastry or Meat Tongs

Whatever you use them for, you'll get years of use out of our most durable tongs.

- IT878** 9 ½" L (24.1 cm)



Salad Server/Pastry Tongs

These elegant stainless steel tongs are perfect for serving individual portions.

- SS782** 8" L (20.3 cm)

Pom Tongs

Crafted from stainless steel. Available in two lengths.

- IT646** 6 ½" L (16.5 cm)
- IT909** 9" L (22.9 cm)

Stainless Steel Double-Mesh Strainers

Double-mesh design provides extra strength. With wooden handles for easy grip.

- SSD50** 4 ¾" ID x 2" H, 12" Overall (11.1 x 5, 30.5 cm)
- SSD65** 5 ¾" ID x 2 ¾" H, 13" Overall (14.6 x 7, 33 cm)
- SSD80** 7 ¼" ID x 3" H, 14 ½" Overall (18.4 x 7.6, 36.8 cm)
- SSD105** 9 ⅞" ID x 4 ½" H, 23" Overall (25.1 x 11.4, 58.4 cm)





Round Mesh Culinary Baskets

These classic nickel-plated strainers are 3" (7.6 cm) deep with 9" (22.9 cm) handles.

Fine Mesh

- CBF8** 8" Dia. (20.3 cm)
(not shown)
- CBF9** 9" Dia. (22.9 cm)
(not shown)
- CBF10** 10" Dia. (25.4 cm)
(not shown)
- CBF12** 12" Dia. (30.5 cm)

Coarse Mesh

- CBC8** 8" Dia. (20.3 cm)
(not shown)
- CBC9** 9" Dia. (22.9 cm)
(not shown)
- CBC10** 10" Dia. (25.4 cm)
(not shown)
- CBC12** 12" Dia. (30.5 cm)



Square Fine Mesh Skimmers HOT

Nickel-plated and durable with 14" (35.6 cm) handle.

- SKS514** 5" Sq. (12.7 cm)
- SKS714** 7" Sq. (17.8 cm)



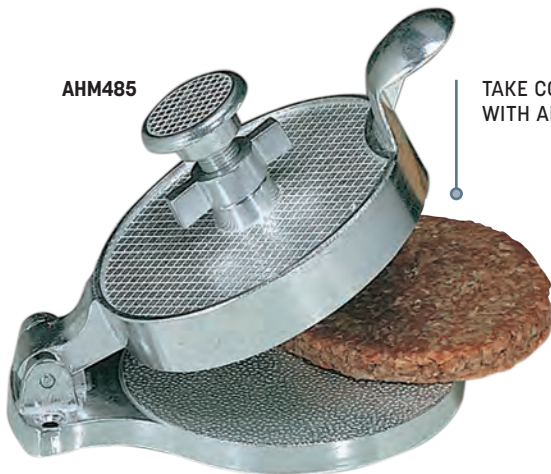

AHM485

TAKE CONTROL OF YOUR PORTIONS
WITH AN ADJUSTABLE MOLD

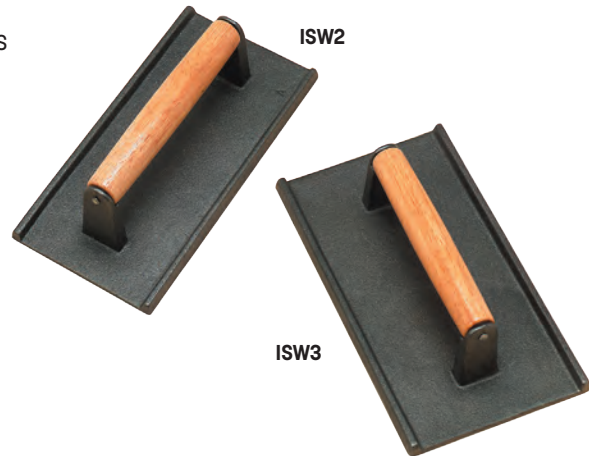

ISW2

ISW3

FOR STRAINER FUNNELS,
REFER TO PG. 360 IN BAR
SUPPLIES

USA



363

1004

524

699

913

Adjustable Burger Mold

Crafted from heavy cast aluminum, this handy tool can press patties up to 3 1/2 oz. (103.5 mL).

AHM485 4 1/2" Dia. (11.4 cm)

Steak Weights

Cast iron weights featuring wooden handles. It's hard to improve upon this classic design.

ISW2 8" L x 4" W (20.3 x 10.2 cm)

ISW3 9" L x 5" W (22.9 x 12.7 cm)

Spun Aluminum Funnels

One-piece spun aluminum in your choice of sizes and weights.

1 mm, 18-gauge Aluminum

363 1/2 Pint (236 mL)
3 7/8" Dia. Funnel x 3 5/8" H
x 5/8" Dia. Neck (9.8 x 9.2 x 1.6 cm)

524 1 Pint (473 mL)
5 1/4" Dia. Funnel x 5 1/4" H
x 11/16" Dia. Neck (13.3 x 13.3 x 1.8 cm)

1.25 mm, 16-gauge Aluminum

699 1 qt. (0.95 L)
7" Dia. Funnel x 6 5/8" H
x 3/4" Dia. Neck (17.8 x 16.8 x 1.9 cm)

913 2 qt. (1.9 L)
9 1/8" Dia. Funnel x 7 3/4" H
x 11/16" Dia. Neck (23.2 x 19.7 x 1.8 cm)

1.5 mm, 14-gauge Aluminum, Heavy-Duty

1004 4 qt. (3.8 L)
8 3/4" Dia. x 8" H
x 3" Dia. Neck (22.2 x 20.3 x 7.6 cm)

Broiler Brush

With one semi-stiff side and one extra-stiff side, this tempered stainless steel scraper can clean even the most burned-on foods. Handle has metal-threaded tip for extra durability and safety.

1423 31" L x 8 1/2" W x 5" H
(78.7 x 21.6 x 12.7 cm)



1423

American METALCRAFT, Inc.



Wire Brushes with Scraper

With tempered steel bristles and your choice of handle.

- 1347** Wooden Handle
● $\frac{3}{4}$ " (1.9 cm) Bristles
 $13 \frac{1}{2}$ " L x $1 \frac{1}{2}$ " H (34.3 x 3.8 cm)
- 1147** Plastic Handle
● $1 \frac{1}{4}$ " (3.2 cm) Bristles
 $11 \frac{3}{4}$ " L x $4 \frac{3}{8}$ " W x $1 \frac{3}{4}$ " H (29.9 x 11.1 x 4.4 cm)

Egg Slicer ● ●

Made from die-cast aluminum. Makes oval or round slices.

- ES474** $4 \frac{1}{4}$ " Dia. x $1 \frac{1}{4}$ " H (10.8 x 3.2 cm)



Coil-Handle Egg Rings

Heavy chrome plating on half round wire. $\frac{3}{8}$ " high (0.95 cm) wall.

- ER333** $3 \frac{1}{4}$ " Dia. (8.3 cm) Ring
 $2 \frac{7}{8}$ " H (7.3 cm) Overall
- ER444** $4 \frac{3}{8}$ " Dia. (11.1 cm) Ring
 $3 \frac{1}{2}$ " H (8.9 cm) Overall



Standard Egg Rings

Rings and handles made from stainless steel. 1" high (2.54 cm) wall to prevent leaks.

- ER387** 4" Dia. (10.2 cm) Ring
 $2 \frac{3}{4}$ " H (7 cm) Overall
- ER487** 5" Dia. (12.7 cm) Ring
 $2 \frac{3}{4}$ " H (7 cm) Overall
- ER587** 6" Dia. (15.2 cm) Ring
 $2 \frac{3}{4}$ " H (7 cm) Overall

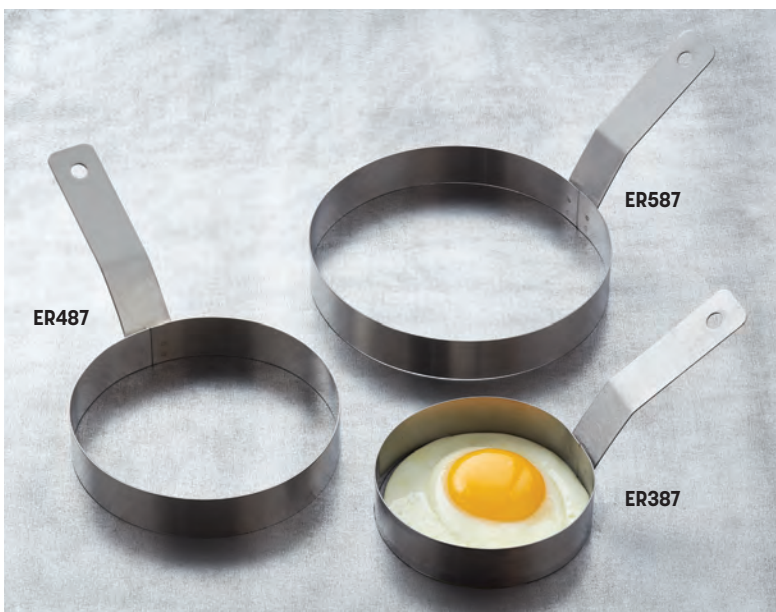

From top to bottom:

- SSB150
- SSB200
- SSB300
- SSB400
- SSB500
- SSB800
- SSB1300
- SSB1600
- SSB2000



SSB75

Stainless Steel Mixing Bowls

In a huge range of ten different sizes, these are the only mixing bowls you'll ever need.

- SSB75** 21 oz. (621 mL)
6 1/2" Dia. x 2 1/8" H
(16.5 x 5.4 cm)
- SSB150** 36 oz. (1.1 L)
7 3/4" Dia. x 2 1/2" H
(19.7 x 6.4 cm)
- SSB200** 55 oz. (1.6 L)
8 1/2" Dia. x 2 3/8" H
(21.6 x 7 cm)
- SSB300** 76 oz. (2.2 L)
9 1/2" Dia. x 3 1/8" H
(24.1 x 7.9 cm)
- SSB400** 100 oz. (3 L)
10 1/2" Dia. x 3 1/2" H
(26.7 x 8.9 cm)
- SSB500** 128 oz. (3.8 L)
11 1/2" Dia. x 3 3/8" H
(29.2 x 9.5 cm)
- SSB800** 179 oz. (5.3 L)
13 1/2" Dia. x 4 1/4" H
(34.3 x 10.8 cm)
- SSB1300** 354 oz. (10.5 L)
16" Dia. x 4 7/8" H
(40.6 x 12.4 cm)
- SSB1600** 512 oz. (15.1 L)
17 1/2" Dia. x 5 5/8" H
(45.1 x 14.3 cm)
- SSB2000** 596 oz. (17.6 L)
19" Dia. x 6" H
(48.3 x 15.2 cm)

Springform Pan

This carbon steel, non-stick springform pan features a durable buckle and removable bottom for creating impressively shaped cakes.

- TSFP10** 10 1/4" Dia. x 2 5/8" H
(26 x 6.7 cm)



TSFP10

DURABLE BUCKLE

Pans and Cutters

Angel Food Cake Pan

Heavy-duty 14-gauge pan. 1.5 mm hard aluminum with satin anodized finish.

AFP958 4 qt. (3.8 L)
10" OD x 4" Deep x 4 1/4" Cone
(25.4 x 10.2 x 10.8 cm)

Doughnut Cutter

One-piece 16-gauge cutter. 1.25 mm satin anodized aluminum.

13001 3" Dia. x 2 1/2" H (7.6 x 6.4 cm)

Biscuit Cutter

One-piece 16-gauge cutter. 1.25 mm satin anodized aluminum.

13005 3" Dia. x 2 1/2" H (7.6 x 6.4 cm)

Stainless Steel Cake Rings

0.036" (0.9 mm) heavy-duty 20-gauge rings to ensure uniform treats.

SR6063 6" Dia. X 3" H
(15.2 x 7.6 cm)

SR6073 7" Dia. X 3" H
(17.8 x 7.6 cm) (not shown)

SR6083 8" Dia. X 3" H
(20.3 x 7.6 cm) (not shown)

SR6093 9" Dia. X 3" H
(22.9 x 7.6 cm) (not shown)

SR6103 10" Dia. X 3" H
(22.9 x 7.6 cm) (not shown)





USA

A80012

Straight-Sided Aluminum Cake Pan Sets

Available in 2" and 3" depths and heavy-weight aluminum options, these cake pans provide the needed sizes for your cake creations.

- A80012** 2" Deep 18-ga., 1 mm
Set includes (1) Each 6", 8", 10", 12", 14" and 16" (15.2, 20.3, 25.4, 30.5, 35.6 and 40.6 x 5.1 cm)
- HA80012** 2" Deep 14-ga., 1.5 mm
Set includes (1) Each 6", 8", 10", 12", 14" and 16" (15.2, 20.3, 25.4, 30.5, 35.6 and 40.6 x 5.1 cm) (not shown)
- 3801** 3" Deep 14-ga., 1.5 mm
Set includes (1) Each 6", 8", 10", 12" and 14" (15.2, 20.3, 25.4, 30.5 and 35.6 x 7.6 cm) (not shown)

Round Aluminum Cake Pans

Heavy-weight 14-ga., 1.5 mm aluminum, 3" Deep.

- 3806** 6" ID x 3" Deep (15.2 x 7.6 cm)
- 3807** 7" ID x 3" Deep (17.8 x 7.6 cm)
- 3808** 8" ID x 3" Deep (20.3 x 7.6 cm)
- 3809** 9" ID x 3" Deep (22.9 x 7.6 cm)
- 3810** 10" ID x 3" Deep (25.4 x 7.6 cm)
- 3812** 12" ID x 3" Deep (30.5 x 7.6 cm)
- 3813** 13" ID x 3" Deep (33 x 7.6 cm)
- 3814** 14" ID x 3" Deep (35.6 x 7.6 cm)

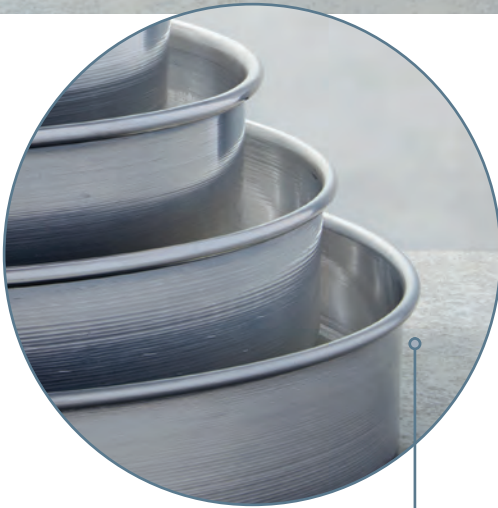

STRAIGHT-SIDED EDGES CREATE SMOOTH CAKE EDGES





TAPERED EDGES CREATE THE PERFECT CRUST

USA



Deep-Dish Aluminum Pie Pans



Standard-weight 18-ga., 1 mm aluminum.

- 801** 7" Top ID x 8" Top OD x 5 1/2" Bottom ID x 1 1/8" Deep (17.8 x 20.3 x 14 x 2.9 cm)
- 897** 8" Top ID x 9" Top OD x 6 1/4" Bottom ID x 1 3/16" Deep (20.3 x 22.9 x 15.9 x 3 cm)
- 989** 9 1/8" Top ID x 9 7/8" Top OD x 7 3/8" Bottom ID x 1 7/8" Deep (23.2 x 25.1 x 18.7 x 4.8 cm) (not shown)
- 1188** 9" Top ID x 10" Top OD x 7 3/4" Bottom ID x 1 1/4" Deep (22.9 x 25.4 x 19.7 x 3.2 cm)
- 1190** 10" Top ID x 11 1/8" Top OD x 8 1/4" Bottom ID x 1 5/16" Deep (25.4 x 28.3 x 21 x 3.3 cm)
- 1200** 10 7/8" Top ID x 11 7/8" Top OD x 9 1/8" Bottom ID x 1 1/4" Deep (27.6 x 30.2 x 23.2 x 3.2 cm)

Standard Aluminum Pie Pans



Standard-weight 18-ga., 1 mm aluminum.

- 475** 4" Top ID x 4 3/8" Top OD x 3" Bottom ID x 1" Deep (10.2 x 11.1 x 7.6 x 2.5 cm)
- 744** 6" Top ID x 7" Top OD x 5 1/2" Bottom ID x 5/8" Deep (15.2 x 17.8 x 14 x 1.6 cm)
- 918** 7 7/8" Top ID x 9 1/8" Top OD x 6 7/8" Bottom ID x 1" Deep (20 x 23.2 x 17.5 x 2.5 cm)
- 1187** 9" Top ID x 10 1/8" Top OD x 8 1/8" Bottom ID x 3/4" Deep (22.9 x 25.7 x 20.6 x 1.9 cm)
- 1300** 11 7/8" Top ID x 13 3/8" Top OD x 10 3/4" Bottom ID x 7/8" Deep (38.1 x 45.6 x 34.9 x 2.2 cm)
- 1600** 15" Top ID x 16" Top OD x 13 3/4" Bottom ID x 7/8" Deep (38.1 x 45.6 x 34.9 x 2.2 cm)

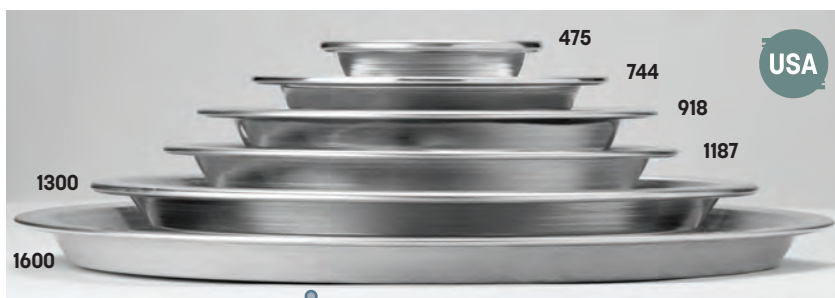

USA

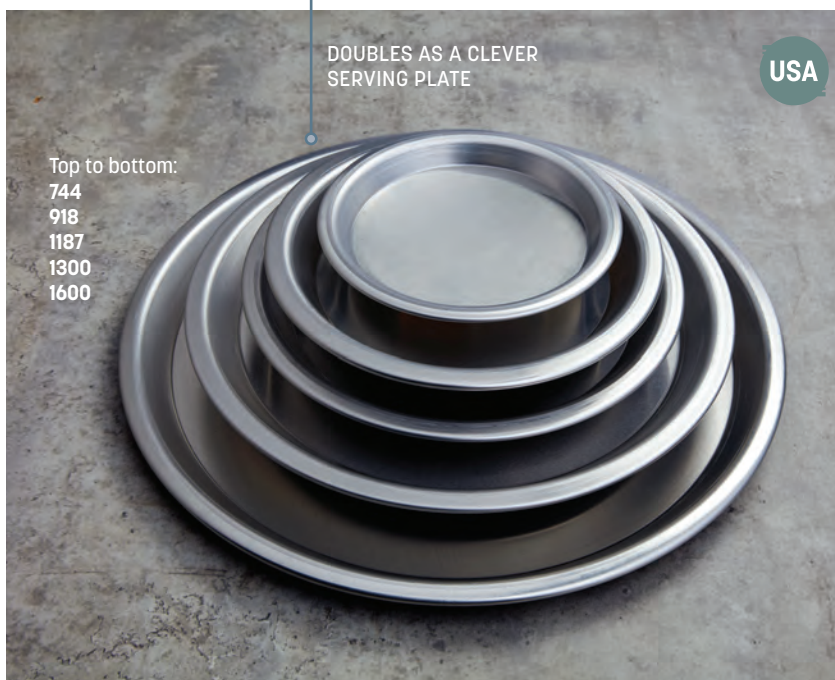

USA

Top to bottom:
744
918
1187
1300
1600



SPR725

Sandwich Spreader

With a stainless steel blade and wooden handle, this tool is elegantly simple.

SPR725 8" L (20.32 cm)

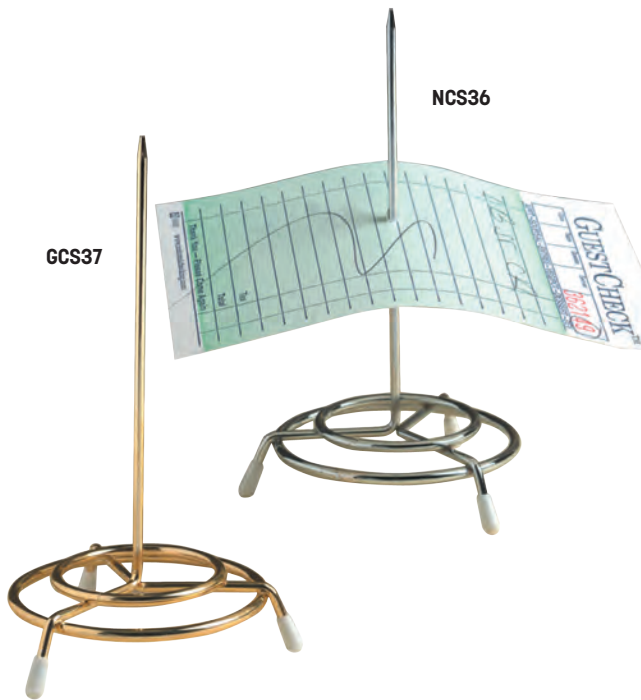

GCS37

NCS36

Check Spindles

Keep used checks in one spot with these classic, retro spindles featuring your choice of metallic plating.

GCS37 Brass-Plated
3" Dia. x 6" H (7.6 x 15.2 cm)

NCS36 Nickel-Plated
3" Dia. x 6" H (7.6 x 15.2 cm)

Call Bell

A real humdinger in nickel-plated stainless steel with a black base.

CB338 3 3/8" Dia. (8.6 cm)

CB338





Short-Height Stainless Steel Ticket Racks

Specifically engineered for modern restaurant needs, these stainless steel ticket racks are the perfect height for most restaurant spaces.

TRSH12 12" L x 1 1/8" H (30.5 x 2.9 cm)

TRSH18 18" L x 1 1/8" H (45.7 x 2.9 cm)

TRSH24 24" L x 1 1/8" H (61 x 2.9 cm)

Stainless Steel Ticket Racks

Marbles inside the groove keep tickets in place. Plastic end caps with screws hold the marbles in.

TR18 18" L x 3 1/2" H (45.7 x 8.9 cm)

TR24 24" L x 3 1/2" H (61 x 8.9 cm)

TR30 30" L x 3 1/2" H (76.2 x 8.9 cm)

TR36 36" L x 3 1/2" H (91.4 x 8.9 cm)

TR48 48" L x 3 1/2" H (121.9 x 8.9 cm)



Aluminum Ticket Racks

Marbles inside hold tickets securely. Attaches easily to walls and racks.

AOR18 18" L x 2 1/2" H (45.7 x 6.4 cm) (not shown)

AOR24 24" L x 2 1/2" H (61 x 6.4 cm) (not shown)

AOR36 36" L x 2 1/2" H (91.4 x 6.4 cm)

AOR48 48" L x 2 1/2" H (121.9 x 6.4 cm) (not shown)





GRILL OR BASTING COVERS WITH BAKELITE KNOBS

Economical basting covers with black Bakelite knobs. Full 2" (5.1 cm) clearance over grill. Ships unassembled with knobs protected in a polybag.

Round Stainless Steel Basting Covers HOT

- BA640S** 6 1/2" Dia. x 2" H (16.5 x 5.1 cm)
- BA740S** 7 1/2" Dia. x 2" H (19.1 x 5.1 cm)
- BA840S** 8 3/8" Dia. x 2" H (21.3 x 5.1 cm)
- BA940S** 9 1/4" Dia. x 2" H (23.5 x 5.1 cm)
- BA1040S** 10 1/2" Dia. x 2 1/8" H (26.7 x 5.4 cm)
- BAKNOB** Extra Knob
Minimum Order 12 Pieces

Round Aluminum Basting Covers HOT USA

- BA640A** 6" Dia. x 2" H (15.3 x 5.1 cm)
- BA740A** 7" Dia. x 2" H (17.8 x 5.1 cm)
- BA840A** 8" Dia. x 2" H (20.3 x 5.1 cm)
- BA940A** 9" Dia. x 2" H (22.9 x 5.1 cm)
- BA1040A** 10" Dia. x 2" H (25.4 x 5.1 cm)
- BAKNOB** Extra Knob
Minimum Order 12 Pieces

Square Aluminum Basting Covers USA

- BASQ620** 6" Sq. x 2" H (15.2 x 5.1 cm)
- BASQ820** 8" Sq. x 2" H (20.3 x 5.1 cm)
- BASQ1020** 10" Sq. x 2" H (25.4 x 5.1 cm)
- BAKNOB** Extra Knob
Minimum Order 12 Pieces



Pizza Pans & Supplies



A Guide to our Pizza Pans

Aluminum Pans

Aluminum is an excellent conductor of heat, providing evenly baked crusts.

Standard-weight pans (denoted with "A" at the beginning of the item number) are made from 18-ga., 0.040", 1 mm aluminum.

Heavy-weight pans (denoted with "HA" at the beginning of the item number) are made from 14-ga., 0.064", 1.5 mm aluminum and are 50% heavier than standard-weight.

- Hand-washing with aluminum-safe detergent is recommended.
- Through repeated use, pans will soften and, if scoured, will thin.

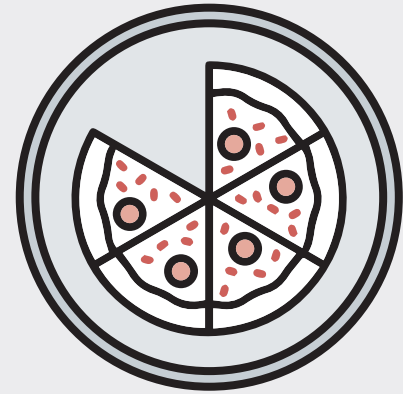

ALUMINUM (A/HA)

Tin Plate Pans

Tin plate is a heavy-weight metal that will darken over time, providing even, efficient cooking.

Tin plate pans (denoted with "T" at the beginning or end of the item number) should be seasoned before use and may need periodic re-seasoning.

- Will darken with use and rust if refrigerated, soaked in water or left unseasoned in damp environments.
- Hand-wash and wipe-dry immediately.
- Call for additional tin plate pan options.

How to Season

To season, wash in warm, soapy water and quickly dry. Brush oil on inside and outside surfaces of the pan and bake to a golden or dark brown. When seasoning, bake at regular times and temperatures. Some pans may need a second or third coating before being fully seasoned.

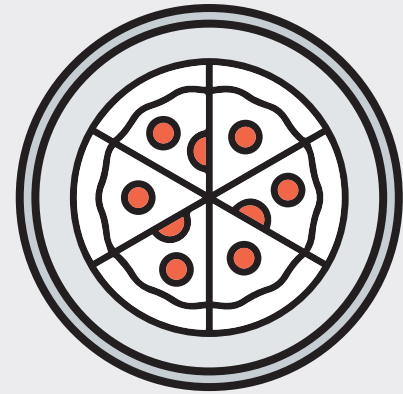

TIN PLATE (T)

Hard Coat Anodized Pans

Heavy-weight and efficient, hard coat aluminum provides quick and efficient results.

Hard coat pans (denoted with "HC" at the beginning or end of the item number) are anodized with a synergistic electro-chemical process that converts the surface of aluminum into a dark aluminum oxide.

- Made from heavy-weight aluminum unless perforated, in which case they're made from standard-weight aluminum.
- Through repeated use, pans will soften and, if scoured, will thin.
- Season before use and hand-wash with aluminum-safe detergent.

How to Season

Wash and dry the pan thoroughly. Wipe oil on the inside and outside surfaces of the pan and allow to soak in for 30 minutes. Then bake at regular cooking times and temperatures. Do not overbake and do not wash off excess oil. The oil residue and any additional oil added before baking allows the pan to develop non-stick properties. Remember when cleaning hard anodized aluminum, this is considered an amphoteric coating and will be attacked by solutions of a high alkaline or acidic nature. Do not expose these pans to dishwashers or caustic cleaning solutions. Hand-wash with detergents made specifically for aluminum.

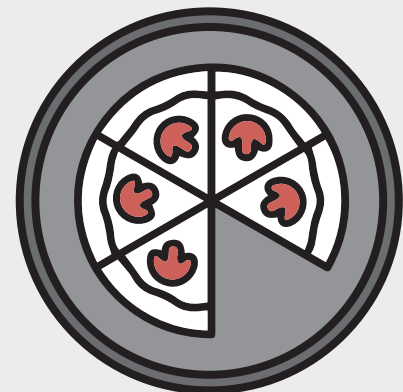

HARD COAT ANODIZED (HC)

Please note:

We carry thousands of different pizza trays in varying styles, depths, materials and other options, resulting in tens of thousands of possible combinations. Because each pan is made to order, it's possible that yours is the first of its kind. Special-order pans cannot be cancelled or returned, so please review and re-confirm your order. If you have any questions, give us a call and, if necessary, request a sample.

Nibs (N)

minimum
order
24 pieces

Nibs raise the pizza off of the baking surface, allowing moisture to escape providing a fresher, crispier pizza.

- Nibs are approximately 5/8" (15.9 mm) in diameter and raise the pizza about 1/8" (3.2 mm) above the surface of the pan.
- Any round or square pizza trays or pans measuring 2" (5.1 cm) deep or less, or between 8" (20.3 cm) and 20" (50.8 cm), can be made with nibs.
- Pans with nibs cannot be perforated.
- To order, add "N" to the beginning of the regular item number and note in the body of the order that the pans should be made with nibs.
- Refer to price list or amnow.com for pricing information.

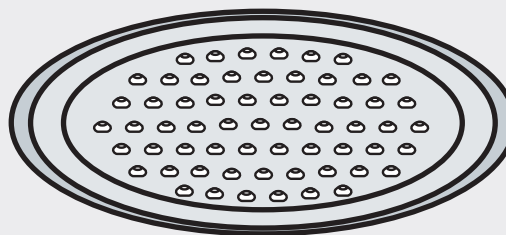

Perf (P)

Perforated pans allow the bottom of the pizza to cook faster and can provide a crispier crust. They can also keep cooked pizzas fresher by allowing moisture to escape.

- Holes are 3/8" (9.5 mm) in diameter.
- Round or square pizza trays or pans less than 21" (53.3 cm) in diameter can be perforated.
- Perf pans cannot be made with nibs.
- To order, add "P" to the beginning or end of the regular item number and note in the body of the order that the pans should be perforated.
- Refer to price list or amnow.com for pricing information.

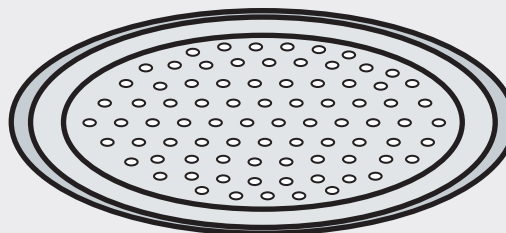

SuperPerf (SP)

SuperPerf pans have twice as many holes as Perf pans, allowing the bottom of the pizza to cook faster and providing a crispier crust. They can also keep cooked pizzas fresher by allowing moisture to escape.

- Holes are 3/8" (9.5 mm) in diameter.
- Round pans less than 21" (53.3 cm) in diameter can be SuperPerf.
- SuperPerf pans cannot be made with nibs.
- To order, add "SP" to the end of the regular item number and note in the body of the order that the pans should be SuperPerf.
- Refer to price list or amnow.com for pricing information.

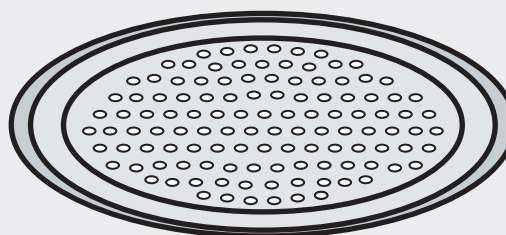

Perf and SuperPerf Hole Guide

For pans with a maximum bottom inside diameter of:		Number of Holes Standard Perf	Number of Holes Super Perf	For pans with a maximum bottom inside diameter of:		Number of Holes Standard Perf	Number of Holes Super Perf
5"	(12.7 cm)	10	20	14"	(35.5 cm)	185	370
6"	(15.2 cm)	21	42	15"	(38.1 cm)	185	370
7"	(17.8 cm)	36	72	16"	(40.6 cm)	228	456
8"	(20.3 cm)	57	114	17"	(43.2 cm)	275	550
9"	(22.9 cm)	57	114	18"	(45.7 cm)	275	550
10"	(25.4 cm)	82	164	19"	(48.2 cm)	326	652
11"	(27.9 cm)	113	226	20"	(50.8 cm)	379	758
12"	(30.5 cm)	113	226	21"	(53.3 cm)	379	758
13"	(33.0 cm)	146	292				

Perf P	Perforating Pans
SuperPerf SP	Double the Holes
Nibs N	Raised Nibs or Bumps

This box is used throughout the Pizza Tray section to denote what options are available for each series. Please note that these options are made to order and may or may not be in stock. For pricing, visit amnow.com

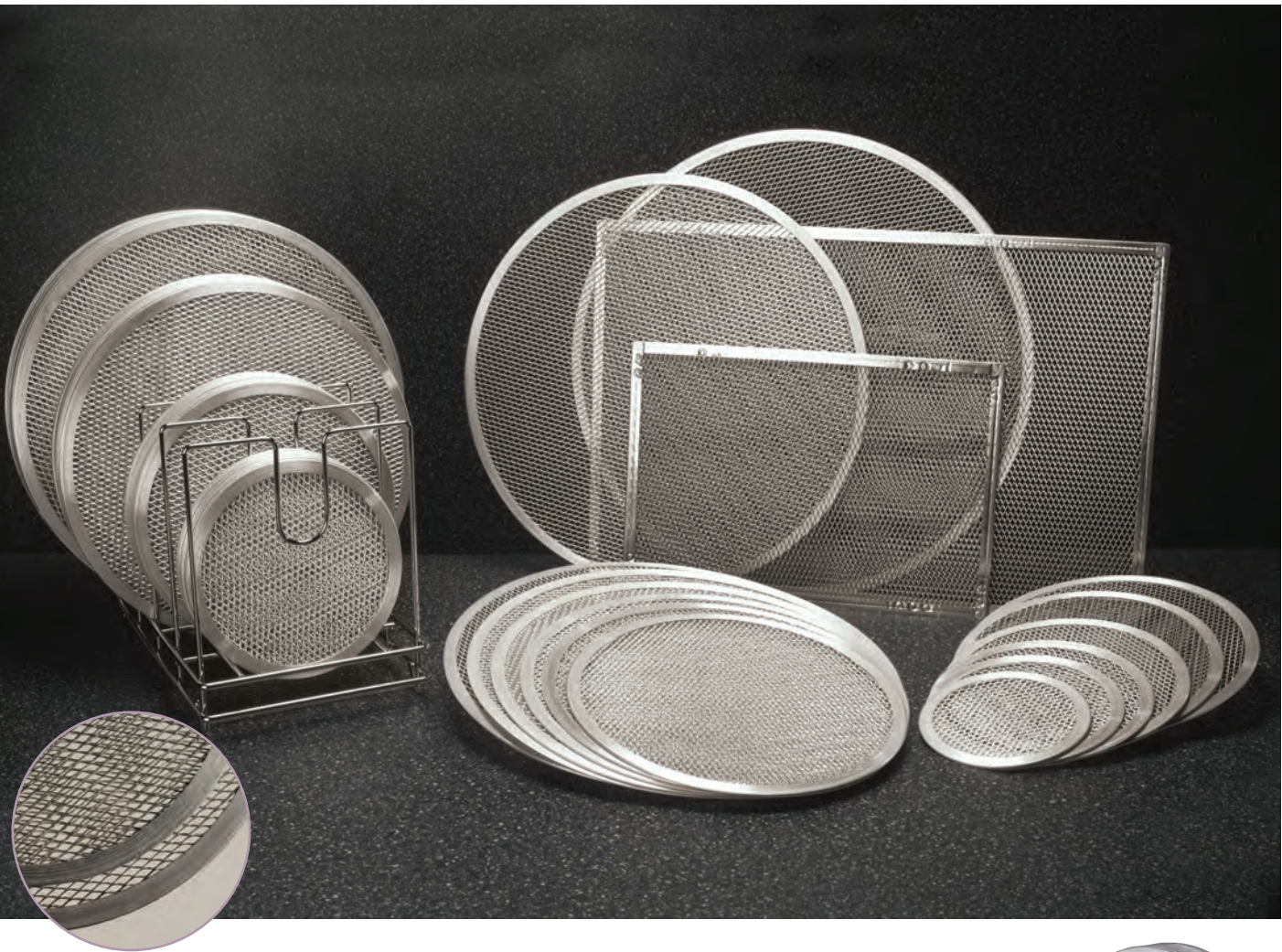

Pizza Screens HOT 🔥

Screens allow for more air circulation than conventional pans, creating a more evenly baked crust.

Round Heavy-Duty Aluminum

18706	6" OD (15.2 cm)
18707	7" OD (17.8 cm)
18708	8" OD (20.3 cm)
18709	9" OD (22.9 cm)
18710	10" OD (25.4 cm)
18711	11" OD (27.9 cm)
18712	12" OD (30.5 cm)
18713	13" OD (33 cm)
18714	14" OD (35.5 cm)
18715	15" OD (38.1 cm)
18716	16" OD (40.6 cm)
18717	17" OD (43.2 cm)
18718	18" OD (45.7 cm)
18719	19" OD (48.2 cm)
18720	20" OD (50.8 cm)
18724*	24" OD (60.9 cm)
18728*	28" OD (71.1 cm)

Rectangular Heavy-Duty Aluminum

18731*	11" L x 16" W (27.9 x 40.6 cm) Fits half-size bun pan
18744*	16" L x 24" W (40.6 x 60.9 cm) Fits full-size bun pan

Pizza Screen Rack 🔥

Inspired by our popular pizza racks on pg. 422, this piece holds up to 96 of our screens. Takes up only 14" x 9" (35.6 x 22.9 cm) of table space and stands 10 1/2" (26.7 cm) tall. Constructed from 3/16" (0.5 cm) chrome-plated steel rods.

18040 Pizza Screen Rack



18040

* Not available in seamless construction

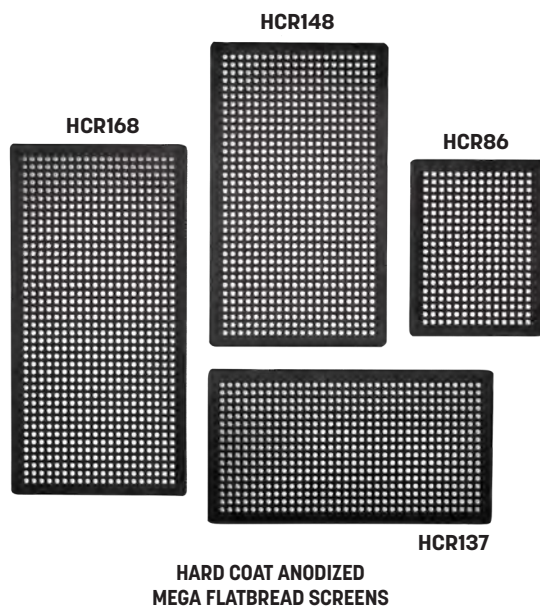

Mega Flatbread Screens - Hard Coat Anodized Aluminum

Why should round pizzas have all the fun? The durability and efficient-baking engineering of our Mega Screens meets a silhouette designed specifically for flatbreads. Features $\frac{3}{32}$ " (0.2 cm) Mega perforations.

Pan Size

8" L x 6 $\frac{1}{8}$ " W (20.3 x 15.6 cm)
 13" L x 7 $\frac{1}{8}$ " W (33 x 18.1 cm)
 14" L x 8" W (35.6 x 20.3 cm)
 16" L x 8" W (40.6 x 20.3 cm)

Hard Coat Anodized Aluminum

HCR86
HCR137
HCR148
HCR168

Mega Disks - Hard Coat Anodized Aluminum

Designed for durable and efficient baking, Mega Disks provide the maximum airflow to cook dough quickly and evenly. Lasts 5-10 times longer than normal screens. Features $\frac{3}{32}$ " (0.2 cm) Mega perforations.

Pan Size

10" Dia. (25.4 cm)
 12" Dia. (30.5 cm)
 14" Dia. (35.6 cm)
 16" Dia. (40.6 cm)
 18" Dia. (45.7 cm)

Hard Coat Anodized Aluminum

HCAD10
HCAD12
HCAD14
HCAD16
HCAD18



Mega Screens - Aluminum

Mega Screens are the smart choice for those looking for a more durable screen option. Holes and open rims make cleaning a breeze and improve food safety. Available in aluminum or hard coat anodized aluminum, Mega Screens can last 5 to 10 times longer than standard pizza screens. Hard Coat Mega Screens are the most durable, cost-effective screens for conveyor oven use. Holes are $\frac{3}{32}$ " (0.2 cm) in diameter.

Pan Size

10" ID x 10 $\frac{3}{4}$ " OD (25.4 x 26.2 cm)
 11" ID x 11 $\frac{3}{4}$ " OD (27.9 x 28.7 cm)
 12" ID x 12 $\frac{3}{4}$ " OD (30.5 x 31.2 cm)
 13" ID x 13 $\frac{3}{4}$ " OD (33.0 x 33.8 cm)
 14" ID x 14 $\frac{3}{4}$ " OD (35.6 x 36.3 cm)
 15" ID x 15 $\frac{3}{4}$ " OD (38.1 x 38.9 cm)
 16" ID x 16 $\frac{3}{4}$ " OD (40.6 x 41.1 cm)
 17" ID x 17 $\frac{3}{4}$ " OD (43.2 x 43.9 cm)
 18" ID x 18 $\frac{3}{4}$ " OD (45.7 x 46.5 cm)

Aluminum

28710
28711
28712
28713
28714
28715
28716
28717
28718

Hard Coat Anodized Aluminum

HC28710
HC28711
HC28712
HC28713
HC28714
HC28715
HC28716
HC28717
HC28718



Refer to pg. 438-439
for care and use
instructions.

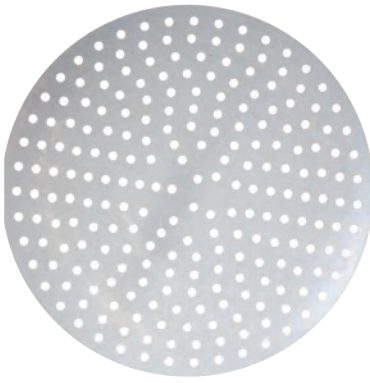

P
Perf aluminum disk

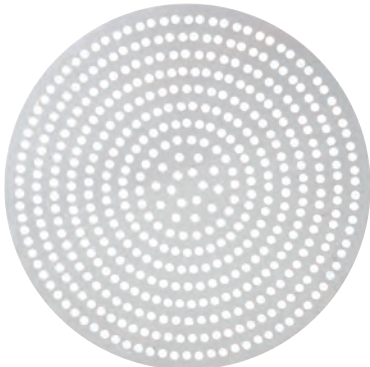

SP
SuperPerf aluminum disk

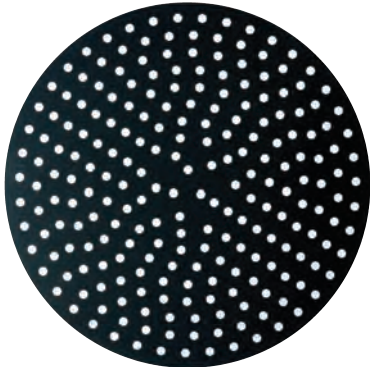

PHC
Perf hard coat anodized disk

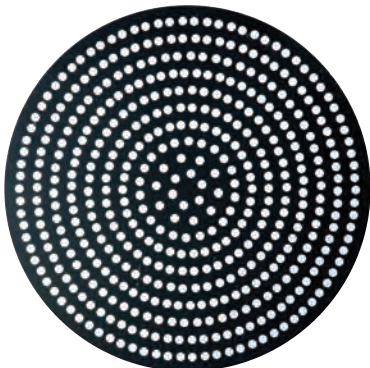

SPHC
SuperPerf hard coat anodized disk

Perf Disks - Aluminum

Manufactured from 18-ga. 1 mm aluminum, these perforated disks produce a more evenly baked crust by allowing for more air circulation. Holes measure $\frac{3}{8}$ " (9.5 mm) in diameter.

Pan Size

7" Dia. (17.8 cm)	36 Holes
8" Dia. (20.3 cm)	57 Holes
9" Dia. (22.9 cm)	57 Holes
10" Dia. (25.4 cm)	82 Holes
11" Dia. (27.9 cm)	113 Holes
12" Dia. (30.5 cm)	113 Holes
13" Dia. (33 cm)	146 Holes
14" Dia. (35.5 cm)	185 Holes
15" Dia. (38.1 cm)	185 Holes
16" Dia. (40.6 cm)	228 Holes
17" Dia. (43.2 cm)	275 Holes
18" Dia. (45.7 cm)	275 Holes
19" Dia. (48.2 cm)	326 Holes
20" Dia. (50.8 cm)	379 Holes

Aluminum

18907P
18908P
18909P
18910P
18911P
18912P
18913P
18914P
18915P
18916P
18917P
18918P
18919P
18920P

Hard Coat Anodized Aluminum

18907PHC
18908PHC
18909PHC
18910PHC
18911PHC
18912PHC
18913PHC
18914PHC
18915PHC
18916PHC
18917PHC
18918PHC
18919PHC
18920PHC

SuperPerf Disks - Aluminum

Pan Size

7" Dia. (17.8 cm)	72 Holes
8" Dia. (20.3 cm)	114 Holes
9" Dia. (22.9 cm)	114 Holes
10" Dia. (25.4 cm)	164 Holes
11" Dia. (27.9 cm)	226 Holes
12" Dia. (30.5 cm)	226 Holes
13" Dia. (33 cm)	292 Holes
14" Dia. (35.5 cm)	370 Holes
15" Dia. (38.1 cm)	370 Holes
16" Dia. (40.6 cm)	456 Holes
17" Dia. (43.2 cm)	550 Holes
18" Dia. (45.7 cm)	550 Holes
19" Dia. (48.2 cm)	652 Holes
20" Dia. (50.8 cm)	758 Holes

Aluminum

18907SP
18908SP
18909SP
18910SP
18911SP
18912SP
18913SP
18914SP
18915SP
18916SP
18917SP
18918SP
18919SP
18920SP

Hard Coat Anodized Aluminum

18907SPHC
18908SPHC
18909SPHC
18910SPHC
18911SPHC
18912SPHC
18913SPHC
18914SPHC
18915SPHC
18916SPHC
18917SPHC
18918SPHC
18919SPHC
18920SPHC

SUPERPERF DISKS FEATURE TWICE AS MANY HOLES AS PERF DISKS



CAR PANS

Heavy-weight 14-ga., 1.5 mm aluminum



CAR HC PANS

Hard coat anodized 14-ga., 1.5 mm aluminum



SHARP EDGE ALSO CUTS DOUGH

CAR Pans - Tapered/Nesting

The edges of these pans are left unfinished so that they're sharp enough to cut dough. Just place a sheet of dough over the pan and use a rolling pin or pie roller to cut it down to size.

PAN DEPTH 5/8" (1.6 CM)

Pan Size

- 6" Top OD x 5" Bottom ID (15.2 x 12.7 cm)
- 7" Top OD x 6" Bottom ID (17.8 x 15.2 cm)
- 7 3/4" Top OD x 6 3/4" Bottom ID (19.7 x 17.1 cm)
- 8 1/2" Top OD x 7 1/2" Bottom ID (21.6 x 19 cm)

**Heavy-Weight
14-ga., 1.5 mm Aluminum**

- CAR6**
- CAR7**
- CAR8**
- CAR9**

**Hard Coat Anodized
14-ga., 1.5 mm Aluminum**

- CAR6HC**
- CAR7HC**
- CAR8HC**
- CAR9HC**

PAN DEPTH 11/16" (1.7 CM)

Pan Size

- 9" Top OD x 8" Bottom ID (22.9 x 20.3 cm)
- 10" Top OD x 9" Bottom ID (25.4 x 22.9 cm)
- 11" Top OD x 10" Bottom ID (27.9 x 25.4 cm)
- 12" Top OD x 11" Bottom ID (30.5 x 27.9 cm)
- 13" Top OD x 12" Bottom ID (33 x 30.5 cm)
- 14" Top OD x 13" Bottom ID (35.5 x 33 cm)
- 15" Top OD x 14" Bottom ID (38.1 x 35.5 cm)
- 16" Top OD x 15" Bottom ID (40.6 x 38.1 cm)
- 17" Top OD x 16" Bottom ID (43.2 x 40.6 cm)
- 18" Top OD x 17" Bottom ID (45.7 x 43.2 cm)
- 19" Top OD x 18" Bottom ID (48.3 x 45.7 cm)
- 20" Top OD x 19" Bottom ID (50.8 x 48.3 cm)
- 21" Top OD x 20" Bottom ID (53.3 x 50.8 cm)
- 29" Top OD x 28" Bottom ID (73.6 x 71.1 cm)

- CAR95**
- CAR10**
- CAR11**
- CAR12**
- CAR13**
- CAR14**
- CAR15**
- CAR16**
- CAR17**
- CAR18**
- CAR19**
- CAR20**
- CAR21**
- CAR29**

- CAR95HC**
- CAR10HC**
- CAR11HC**
- CAR12HC**
- CAR13HC**
- CAR14HC**
- CAR15HC**
- CAR16HC**
- CAR17HC**
- CAR18HC**
- CAR19HC**
- CAR20HC**
- CAR21HC**



HATP
Heavy-weight
14-ga., 1.5 mm
aluminum



HEAVY-DUTY ALUMINUM
ADDS TO LONGER LIFE

TP
Standard-weight
18-ga., 1 mm aluminum



HCTP
Hard coat anodized
14-ga., 1.5 mm aluminum



TP Series Wide-Rim Pans

There's a reason that the pizza industry has trusted American Metalcraft since 1947. Often imitated, but never duplicated, our signature TP Series of serving trays offers unbeatable reliability and durability, thanks to heavy-duty 14 and 18-ga. aluminum construction.

<u>Pan Size</u>	<u>TP Standard-Weight 18-ga., 1 mm Aluminum</u>	<u>HATP Heavy-Weight 14-ga., 1.5 mm Aluminum</u>	<u>HCTP Hard Coat Anodized 14-ga., 1.5 mm Aluminum</u>
6" OD x 4 1/2" ID (15.2 x 11.4 cm)	TP6	HATP6	HCTP6
7" OD x 5 1/2" ID (17.8 x 14 cm)	TP7	HATP7	HCTP7
8" OD x 6" ID (20.3 x 16.5 cm)	TP8	HATP8	HCTP8
9" OD x 7" ID (22.9 x 19.1 cm)	TP9	HATP9	HCTP9
10" OD x 8" ID (25.4 x 20.3 cm)	TP10	HATP10	HCTP10
11" OD x 9" ID (27.9 x 22.9 cm)	TP11	HATP11	HCTP11
12" OD x 10" ID (30.5 x 25.4 cm)	TP12	HATP12	HCTP12
13" OD x 11" ID (33 x 27.9 cm)	TP13	HATP13	HCTP13
14" OD x 12" ID (35.5 x 30.5 cm)	TP14	HATP14	HCTP14
15" OD x 13" ID (38.1 x 33 cm)	TP15	HATP15	HCTP15
16" OD x 14" ID (40.6 x 35.5 cm)	TP16	HATP16	HCTP16
17" OD x 15" ID (43.2 x 38.1 cm)	TP17	HATP17	HCTP17
18" OD x 16" ID (45.7 x 40.6 cm)	TP18	HATP18	HCTP18
19" OD x 17" ID (48.2 x 43.2 cm)	TP19	HATP19	HCTP19
20" OD x 18" ID (50.8 x 45.7 cm)	TP20	HATP20	HCTP20
21" OD x 19" ID (53.3 x 48.3 cm)		HATP21	
22" OD x 20" ID (55.9 x 50.8 cm)		HATP22	
23" OD x 21" ID (58.4 x 53.3 cm)		HATP23	
24" OD x 22" ID (61 x 55.9 cm)		HATP24	
26" OD x 24" ID (66 x 61 cm)		HATP26	
28" OD x 26" ID (71.1 x 66 cm)		HATP28	



HACTP
Heavy-weight
14-ga., 1.5 mm
aluminum



CTP
Standard-weight
18-ga., 1 mm aluminum



HCCTP
Hard coat anodized
14-ga., 1.5 mm aluminum



CTP Series Coupe-Style Pans

Just like our signature TP Series, these coupe-style pans are manufactured from the finest grade of aluminum. They'll last longer than your average pizza pan, making them a financially savvy choice to serve pizzas.

<u>Pan Size</u>	<u>CTP Standard-Weight 18-ga., 1 mm Aluminum</u>	<u>HACTP Heavy-Weight 14-ga., 1.5 mm Aluminum</u>	<u>HCCTP Hard Coat Anodized 14-ga., 1.5 mm Aluminum</u>
6" OD x 4 1/2" ID (15.2 x 11.4 cm)	CTP6	HACTP6	HCCTP6
7" OD x 5 1/2" ID (17.8 x 14 cm)	CTP7	HACTP7	HCCTP7
8" OD x 6" ID (20.3 x 16.5 cm)	CTP8	HACTP8	HCCTP8
9" OD x 7" ID (22.9 x 19.1 cm)	CTP9	HACTP9	HCCTP9
10" OD x 8" ID (25.4 x 20.3 cm)	CTP10	HACTP10	HCCTP10
11" OD x 9" ID (27.9 x 22.9 cm)	CTP11	HACTP11	HCCTP11
12" OD x 10" ID (30.5 x 25.4 cm)	CTP12	HACTP12	HCCTP12
13" OD x 11" ID (33 x 27.9 cm)	CTP13	HACTP13	HCCTP13
14" OD x 12" ID (35.5 x 30.5 cm)	CTP14	HACTP14	HCCTP14
15" OD x 13" ID (38.1 x 33 cm)	CTP15	HACTP15	HCCTP15
16" OD x 14" ID (40.6 x 35.5 cm)	CTP16	HACTP16	HCCTP16
17" OD x 15" ID (43.2 x 38.1 cm)	CTP17	HACTP17	HCCTP17
18" OD x 16" ID (45.7 x 40.6 cm)	CTP18	HACTP18	HCCTP18
19" OD x 17" ID (48.2 x 43.2 cm)	CTP19	HACTP19	HCCTP19
20" OD x 18" ID (50.8 x 45.7 cm)		HACTP20	HCCTP20
21" OD x 19" ID (53.3 x 48.3 cm)		HACTP21	
22" OD x 20" ID (55.9 x 50.8 cm)		HACTP22	
23" OD x 21" ID (58.4 x 53.3 cm)		HACTP23	
24" OD x 22" ID (61 x 55.9 cm)		HACTP24	
26" OD x 24" ID (66 x 61 cm)		HACTP26	
28" OD x 26" ID (71.1 x 66 cm)		HACTP28	



A2000
Standard-weight
18-ga., 1 mm aluminum

HA2000
Heavy-weight
14-ga., 1.5 mm aluminum



DESIGNED TO NEST FOR
SPACE-SAVING STORAGE



HC2000
Hard coat anodized
14-ga., 1.5 mm aluminum

2000 Series - Tapered/Nesting  

PAN DEPTH 1/2" (1.3 CM)

Pan Size

- 6" Top ID x 5 5/8" Bottom ID (15.2 x 14.3 cm)
- 7" Top ID x 6 5/8" Bottom ID (17.8 x 16.8 cm)
- 8" Top ID x 7 5/8" Bottom ID (20.3 x 19.4 cm)
- 9" Top ID x 8 5/8" Bottom ID (22.9 x 21.9 cm)
- 10" Top ID x 9 5/8" Bottom ID (25.4 x 24.4 cm)
- 11" Top ID x 10 5/8" Bottom ID (27.9 x 26.9 cm)
- 12" Top ID x 11 5/8" Bottom ID (30.5 x 29.5 cm)
- 13" Top ID x 12 5/8" Bottom ID (33 x 32 cm)
- 14" Top ID x 13 5/8" Bottom ID (35.5 x 34.6 cm)
- 15" Top ID x 14 5/8" Bottom ID (38.1 x 37.1 cm)
- 16" Top ID x 15 5/8" Bottom ID (40.6 x 39.7 cm)
- 17" Top ID x 16 5/8" Bottom ID (43.2 x 42.2 cm)
- 18" Top ID x 17 5/8" Bottom ID (45.7 x 44.7 cm)

**A2000 Standard-Weight
18-ga., 1 mm Aluminum**

- A2006
- A2007
- A2008
- A2009
- A2010
- A2011
- A2012
- A2013
- A2014
- A2015
- A2016
- A2017
- A2018

**HA2000 Heavy-Weight
14-ga., 1.5 mm Aluminum**

- HA2006
- HA2007
- HA2008
- HA2009
- HA2010
- HA2011
- HA2012
- HA2013
- HA2014
- HA2015
- HA2016
- HA2017
- HA2018

**HC2000 Hard Coat Anodized
14-ga., 1.5 mm Aluminum**

- HC2006
- HC2007
- HC2008
- HC2009
- HC2010
- HC2011
- HC2012
- HC2013
- HC2014
- HC2015
- HC2016
- HC2017
- HC2018

HADEP
Heavy-weight
14-ga., 1.5 mm aluminum



ADEP
Standard-weight
18-ga., 1 mm aluminum



HCDEP
Hard coat anodized
14-ga., 1.5 mm aluminum

DEP Series - Tapered/Nesting

PAN DEPTH 1" (2.5 CM)

Pan Size

- 6" Top ID x 5 5/8" Bottom ID (15.2 x 14.3 cm)
- 7" Top ID x 6 5/8" Bottom ID (17.8 x 16.8 cm)
- 8" Top ID x 7 5/8" Bottom ID (20.3 x 19.4 cm)
- 9" Top ID x 8 5/8" Bottom ID (22.9 x 21.9 cm)
- 10" Top ID x 9 5/8" Bottom ID (25.4 x 24.4 cm)
- 11" Top ID x 10 5/8" Bottom ID (27.9 x 26.9 cm)
- 12" Top ID x 11 5/8" Bottom ID (30.5 x 29.5 cm)
- 13" Top ID x 12 5/8" Bottom ID (33 x 32 cm)
- 14" Top ID x 13 5/8" Bottom ID (35.5 x 34.6 cm)
- 15" Top ID x 14 5/8" Bottom ID (38.1 x 37.1 cm)
- 16" Top ID x 15 5/8" Bottom ID (40.6 x 39.7 cm)
- 17" Top ID x 16 5/8" Bottom ID (43.2 x 42.2 cm)
- 18" Top ID x 17 5/8" Bottom ID (45.7 x 44.7 cm)
- 19" Top ID x 18 1/4" Bottom ID (48.3 x 46.4 cm)

**ADEP Standard-Weight
18-ga., 1 mm Aluminum**

- ADEP6
- ADEP7
- ADEP8
- ADEP9
- ADEP10
- ADEP11
- ADEP12
- ADEP13
- ADEP14
- ADEP15
- ADEP16
- ADEP17
- ADEP18

**HADEP Heavy-Weight
14-ga., 1.5 mm Aluminum**

- HADEP6
- HADEP7
- HADEP8
- HADEP9
- HADEP10
- HADEP11
- HADEP12
- HADEP13
- HADEP14
- HADEP15
- HADEP16
- HADEP17
- HADEP18
- HADEP19

**HCDEP Hard Coat Anodized
14-ga., 1.5 mm Aluminum**

- HCDEP6
- HCDEP7
- HCDEP8
- HCDEP9
- HCDEP10
- HCDEP11
- HCDEP12
- HCDEP13
- HCDEP14
- HCDEP15
- HCDEP16
- HCDEP17
- HCDEP18

Perf P Perforating Pans
SuperPerf SP Double the Holes
Nibs N Raised Nibs or Bumps

Covers Separators and 7000 pans (pg. 399) can be used as covers
Stacking 7000 pans (pg. 399) are stacking covers for tapered pans
Refer to pg. 438-439 for care and use instructions. For pricing, visit amnow.com



9000 Series Pan
shown seasoned



A9000
Standard-weight
18-ga., 1 mm aluminum



9000 SERIES - Tapered/Nesting

PAN DEPTH 1 1/8" (2.9 CM)

Pan Size

5" Top ID x 4 3/8" Bottom ID (12.7 x 11.1 cm)

5 1/2" Top ID x 5" Bottom ID (13.9 x 12.7 cm)

**A9000 Standard-Weight
18-ga., 1 mm Aluminum**

A9005

A9006

PAN DEPTH 1 1/2" (3.8 CM)

Pan Size

6" Top ID x 5 1/2" Bottom ID (15.2 x 13.9 cm)

7" Top ID x 6 1/4" Bottom ID (17.8 x 15.8 cm)

8" Top ID x 7 1/4" Bottom ID (20.3 x 18.4 cm)

9" Top ID x 8 1/4" Bottom ID (22.8 x 20.9 cm)

10" Top ID x 9 1/4" Bottom ID (25.4 x 23.5 cm)

11" Top ID x 10 1/4" Bottom ID (27.9 x 26 cm)

12" Top ID x 11 1/4" Bottom ID (30.5 x 28.6 cm)

13" Top ID x 12 1/4" Bottom ID (33 x 31.1 cm)

14" Top ID x 13 1/4" Bottom ID (35.5 x 33.6 cm)

15" Top ID x 14 1/4" Bottom ID (38.1 x 36.2 cm)

16" Top ID x 15 1/4" Bottom ID (40.6 x 38.7 cm)

A90671.5

A90071.5

A90081.5

A90091.5

A90101.5

A90111.5

A90121.5

A90131.5

A90141.5

A90151.5

A90161.5

PAN DEPTH 2" (5.1 CM)

Pan Size

6" Top ID x 5" Bottom ID (15.2 x 12.7 cm)

7" Top ID x 6" Bottom ID (17.8 x 15.2 cm)

8" Top ID x 7" Bottom ID (20.3 x 17.8 cm)

9" Top ID x 8" Bottom ID (22.8 x 20.3 cm)

10" Top ID x 9" Bottom ID (25.4 x 22.8 cm)

11" Top ID x 10" Bottom ID (27.9 x 25.4 cm)

12" Top ID x 11" Bottom ID (30.5 x 27.9 cm)

13" Top ID x 12" Bottom ID (33 x 30.5 cm)

14" Top ID x 13" Bottom ID (35.5 x 33 cm)

15" Top ID x 14" Bottom ID (38.1 x 35.5 cm)

16" Top ID x 15" Bottom ID (40.6 x 38.1 cm)

A90672

A90072

A90082

A90092

A90102

A90112

A90122

A90132

A90142

A90152

A90162

HA9000
Heavy-weight
14-ga., 1.5 mm
aluminum



HC9000
Hard coat anodized
14-ga., 1.5 mm
aluminum



9000 SERIES - Tapered/Nesting  

PAN DEPTH 1 1/8" (2.9 CM)

Pan Size

- 5" Top ID x 4 3/8" Bottom ID (12.7 x 11.1 cm)
- 5 1/2" Top ID x 5" Bottom ID (13.9 x 12.7 cm)

**HA9000 Heavy-Weight
14-ga., 1.5 mm Aluminum**

- HA9005**
- HA9006**

**HC9000 Hard Coat Anodized
14-ga., 1.5 mm Aluminum**

- HC9005**
- HC9006**

PAN DEPTH 1 1/2" (3.8 CM)

Pan Size

- 6" Top ID x 5 1/2" Bottom ID (15.2 x 13.9 cm)
- 7" Top ID x 6 1/4" Bottom ID (17.8 x 15.8 cm)
- 8" Top ID x 7 1/4" Bottom ID (20.3 x 18.4 cm)
- 9" Top ID x 8 1/4" Bottom ID (22.8 x 20.9 cm)
- 10" Top ID x 9 1/4" Bottom ID (25.4 x 23.5 cm)
- 11" Top ID x 10 1/4" Bottom ID (27.9 x 26 cm)
- 12" Top ID x 11 1/4" Bottom ID (30.5 x 28.6 cm)
- 13" Top ID x 12 1/4" Bottom ID (33 x 31.1 cm)
- 14" Top ID x 13 1/4" Bottom ID (35.5 x 33.6 cm)
- 15" Top ID x 14 1/4" Bottom ID (38.1 x 36.2 cm)
- 16" Top ID x 15 1/4" Bottom ID (40.6 x 38.7 cm)
- 17" Top ID x 16 1/4" Bottom ID (43.2 x 41.3 cm)
- 18" Top ID x 17 1/4" Bottom ID (45.7 x 43.8 cm)

- HA90671.5**
- HA90071.5**
- HA90081.5**
- HA90091.5**
- HA90101.5**
- HA90111.5**
- HA90121.5**
- HA90131.5**
- HA90141.5**
- HA90151.5**
- HA90161.5**
- HA90171.5**
- HA90181.5**

- HC90671.5**
- HC90071.5**
- HC90081.5**
- HC90091.5**
- HC90101.5**
- HC90111.5**
- HC90121.5**
- HC90131.5**
- HC90141.5**
- HC90151.5**
- HC90161.5**
- HC90171.5**
- HC90181.5**

PAN DEPTH 2" (5.1 CM)

Pan Size

- 6" Top ID x 5" Bottom ID (15.2 x 12.7 cm)
- 7" Top ID x 6" Bottom ID (17.8 x 15.2 cm)
- 8" Top ID x 7" Bottom ID (20.3 x 17.8 cm)
- 9" Top ID x 8" Bottom ID (22.8 x 20.3 cm)
- 10" Top ID x 9" Bottom ID (25.4 x 22.8 cm)
- 11" Top ID x 10" Bottom ID (27.9 x 25.4 cm)
- 12" Top ID x 11" Bottom ID (30.5 x 27.9 cm)
- 13" Top ID x 12" Bottom ID (33 x 30.5 cm)
- 14" Top ID x 13" Bottom ID (35.5 x 33 cm)
- 15" Top ID x 14" Bottom ID (38.1 x 35.5 cm)
- 16" Top ID x 15" Bottom ID (40.6 x 38.1 cm)
- 17" Top ID x 16" Bottom ID (43.2 x 40.6 cm)
- 18" Top ID x 17" Bottom ID (45.7 x 43.2 cm)

- HA90672**
- HA90072**
- HA90082**
- HA90092**
- HA90102**
- HA90112**
- HA90122**
- HA90132**
- HA90142**
- HA90152**
- HA90162**
- HA90172**
- HA90182**

- HC90672**
- HC90072**
- HC90082**
- HC90092**
- HC90102**
- HC90112**
- HC90122**
- HC90132**
- HC90142**
- HC90152**
- HC90162**
- HC90172**
- HC90182**



A4000
Standard-weight
18-ga., 1 mm
aluminum



HA4000
Heavy-weight
14-ga., 1.5 mm
aluminum



HC4000
Hard coat anodized
14-ga., 1.5 mm
aluminum



4000 SERIES - Straight-Sided

PAN DEPTH 3/4" (1.9 CM)

Pan Size

4" ID (10.2 cm)

Standard-Weight
18-ga., 1 mm Aluminum

A4004

Heavy-Weight
14-ga., 1.5 mm Aluminum

Hard Coat Anodized
14-ga., 1.5 mm Aluminum

PAN DEPTH 1" (2.5 CM)

Pan Size

6" ID (15.2 cm)

7" ID (17.8 cm)

8" ID (20.3 cm)

9" ID (22.9 cm)

10" ID (25.4 cm)

11" ID (27.9 cm)

12" ID (30.5 cm)

13" ID (33 cm)

14" ID (35.5 cm)

15" ID (38.1 cm)

16" ID (40.6 cm)

17" ID (43.2 cm)

18" ID (45.7 cm)

19" ID (48.3 cm)

20" ID (50.8 cm)

A4006

A4007

A4008

A4009

A4010

A4011

A4012

A4013

A4014

A4015

A4016

HA4006

HA4007

HA4008

HA4009

HA4010

HA4011

HA4012

HA4013

HA4014

HA4015

HA4016

HA4017

HA4018

HA4019

HA4020

HC4006

HC4007

HC4008

HC4009

HC4010

HC4011

HC4012

HC4013

HC4014

HC4015

HC4016

HC4017

HC4018

HC4019

HC4020

8000 SERIES - Straight-Sided **PAN DEPTH 1 1/2" (3.8 CM)**Pan Size

6" ID (15.2 cm)
7" ID (17.8 cm)
8" ID (20.3 cm)
9" ID (22.9 cm)
10" ID (25.4 cm)
12" ID (30.5 cm)

**A8000 Standard-Weight
18-ga., 1 mm Aluminum**

A80061.5
A80071.5
A80081.5
A80091.5
A80101.5
A80121.5

**T8000 Tin Plate
22-ga., Tin Plate on Steel**

T80061.5
T80071.5
T80081.5
T80091.5
T80101.5
T80121.5

USA



A8000
Standard-weight 18-ga., 1 mm aluminum

PAN DEPTH 2" (5.1 CM)Pan Size

6" ID (15.2 cm)
7" ID (17.8 cm)
8" ID (20.3 cm)
9" ID (22.9 cm)
10" ID (25.4 cm)
11" ID (27.9 cm)
12" ID (30.5 cm)
13" ID (33 cm)
14" ID (35.5 cm)
16" ID (40.6 cm)

A80062
A80072
A80082
A80092
A80102
A80112
A80122
A80132
A80142
A80162

T80062
T80072
T80082
T80092
T80102
T80112
T80122
T80132
T80142
T80162

PAN DEPTH 1 1/2" (3.8 CM)Pan Size

6" ID (15.2 cm)
7" ID (17.8 cm)
8" ID (20.3 cm)
9" ID (22.9 cm)
10" ID (25.4 cm)
12" ID (30.5 cm)

**HA8000 Heavy-Weight
14-ga., 1.5 mm Aluminum**

HA80061.5
HA80071.5
HA80081.5
HA80091.5
HA80101.5
HA80121.5

**HC8000 Hard Coat Anodized
14-ga., 1.5 mm Aluminum**

HC80061.5
HC80071.5
HC80081.5
HC80091.5
HC80101.5
HC80121.5



T8000
22-ga., tin plate on steel

PAN DEPTH 2" (5.1 CM)Pan Size

6" ID (15.2 cm)
7" ID (17.8 cm)
8" ID (20.3 cm)
9" ID (22.9 cm)
10" ID (25.4 cm)
11" ID (27.9 cm)
12" ID (30.5 cm)
13" ID (33 cm)
14" ID (35.5 cm)
16" ID (40.6 cm)
18" ID (45.7 cm)

HA80062
HA80072
HA80082
HA80092
HA80102
HA80112
HA80122
HA80132
HA80142
HA80162
HA80182

HC80062
HC80072
HC80082
HC80092
HC80102
HC80112
HC80122
HC80132
HC80142
HC80162
HC80182



HA8000
Heavy-weight 14-ga., 1.5 mm aluminum



HC8000
Hard coat anodized 14-ga., 1.5 mm aluminum



USA

ALL PANS ARE 1 1/2" DEEP WITH 1" INSIDE PAN WHEN STACKED. BOTTOM OF ONE PAN NESTS 1/2" INTO THE TOP OF THE PAN BELOW.

HA5100
Heavy-weight
14-ga., 1.5 mm
aluminum

HC5100
Hard coat
anodized
14-ga., 1.5 mm
aluminum

USA



ALL PANS ARE 2" DEEP WITH 1 1/2" INSIDE PAN WHEN STACKED. BOTTOM OF ONE PAN NESTS 1/2" INTO THE TOP OF THE PAN BELOW.

HA5000
Heavy-weight
14-ga., 1.5 mm
aluminum

HC5000
Hard coat
anodized
14-ga., 1.5 mm
aluminum



5100 SERIES - Straight-Sided - Self-Stacking

USA

PAN DEPTH 1 1/2" (3.8 CM)

Pan Size

- 6" Top ID x 5 7/8" Bottom ID (15.2 x 14.9 cm)
- 7" Top ID x 6 7/8" Bottom ID (17.8 x 17.5 cm)
- 8" Top ID x 7 7/8" Bottom ID (20.3 x 20 cm)
- 9" Top ID x 8 7/8" Bottom ID (22.9 x 22.5 cm)
- 10" Top ID x 9 7/8" Bottom ID (25.4 x 25.1 cm)
- 11" Top ID x 10 7/8" Bottom ID (27.9 x 27.6 cm)
- 12" Top ID x 11 7/8" Bottom ID (30.5 x 30.1 cm)
- 13" Top ID x 12 7/8" Bottom ID (33 x 32.7 cm)
- 14" Top ID x 13 7/8" Bottom ID (35.5 x 35.2 cm)
- 15" Top ID x 14 7/8" Bottom ID (38.1 x 37.8 cm)
- 16" Top ID x 15 7/8" Bottom ID (40.6 x 40.3 cm)

**HA5100 Heavy-Weight
14-ga., 1.5 mm Aluminum**

- HA5106
- HA5107
- HA5108
- HA5109
- HA5110
- HA5111
- HA5112
- HA5113
- HA5114
- HA5115
- HA5116

**HC5100 Hard Coat Anodized
14-ga., 1.5 mm Aluminum**

- HC5106
- HC5107
- HC5108
- HC5109
- HC5110
- HC5111
- HC5112
- HC5113
- HC5114
- HC5115
- HC5116

5000 SERIES - Straight-Sided - Self-Stacking

USA

PAN DEPTH 2" (5.1 CM)

Pan Size

- 6" Top ID x 5 7/8" Bottom ID (15.2 x 14.9 cm)
- 7" Top ID x 6 7/8" Bottom ID (17.8 x 17.5 cm)
- 8" Top ID x 7 7/8" Bottom ID (20.3 x 20 cm)
- 9" Top ID x 8 7/8" Bottom ID (22.9 x 22.5 cm)
- 10" Top ID x 9 7/8" Bottom ID (25.4 x 25.1 cm)
- 11" Top ID x 10 7/8" Bottom ID (27.9 x 27.6 cm)
- 12" Top ID x 11 7/8" Bottom ID (30.5 x 30.1 cm)
- 13" Top ID x 12 7/8" Bottom ID (33 x 32.7 cm)
- 14" Top ID x 13 7/8" Bottom ID (35.5 x 35.2 cm)
- 15" Top ID x 14 7/8" Bottom ID (38.1 x 37.8 cm)
- 16" Top ID x 15 7/8" Bottom ID (40.6 x 40.3 cm)
- 17" Top ID x 16 7/8" Bottom ID (43.2 x 42.9 cm)
- 18" Top ID x 17 7/8" Bottom ID (45.7 x 45.4 cm)

**HA5000 Heavy-Weight
14-ga., 1.5 mm Aluminum**

- HA5006
- HA5007
- HA5008
- HA5009
- HA5010
- HA5011
- HA5012
- HA5013
- HA5014
- HA5015
- HA5016
- HA5017
- HA5018

**HC5000 Hard Coat Anodized
14-ga., 1.5 mm Aluminum**

- HC5006
- HC5007
- HC5008
- HC5009
- HC5010
- HC5011
- HC5012
- HC5013
- HC5014
- HC5015
- HC5016
- HC5017
- HC5018

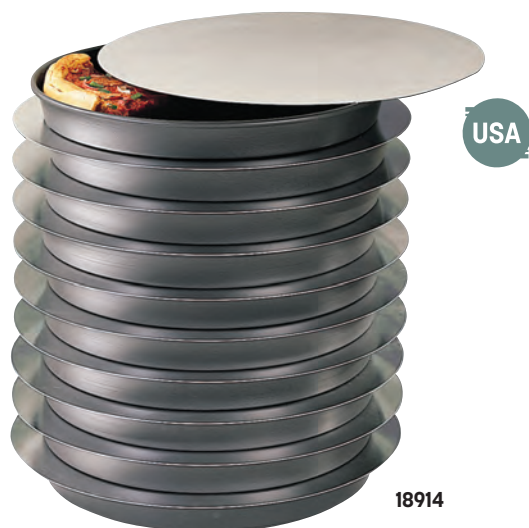

18914

ROUND SEPARATORS



To choose a separator, measure the top outside diameter of your pan and add at least 2". Unfinished edges may be sharp.

Standard-Weight 18-ga., 1 mm Aluminum

18907	7" OD (17.8 cm) Separates 5" (12.7 cm) Dia. and smaller pans
18908	8" OD (20.3 cm) Separates 6" (15.2 cm) Dia. and smaller pans
18909	9" OD (22.9 cm) Separates 7" (17.8 cm) Dia. and smaller pans
18910	10" OD (25.4 cm) Separates 8" (20.3 cm) Dia. and smaller pans
18911	11" OD (27.9 cm) Separates 9" (22.9 cm) Dia. and smaller pans
18912	12" OD (30.5 cm) Separates 10" (25.4 cm) Dia. and smaller pans
18913	13" OD (33 cm) Separates 11" (27.9 cm) Dia. and smaller pans
18914	14" OD (35.6 cm) Separates 12" (30.5 cm) Dia. and smaller pans
18915	15" OD (38.1 cm) Separates 13" (33 cm) Dia. and smaller pans
18916	16" OD (40.6 cm) Separates 14" (35.6 cm) Dia. and smaller pans
18917	17" OD (43.2 cm) Separates 15" (38.1 cm) Dia. and smaller pans
18918	18" OD (45.7 cm) Separates 16" (40.6 cm) Dia. and smaller pans
18919	19" OD (48.2 cm) Separates 17" (43.2 cm) Dia. and smaller pans
18920	20" OD (50.8 cm) Separates 18" (45.7 cm) Dia. and smaller pans

7000 SERIES



These can be used as stacking covers for our DEP, 2000 and 9000 Series, or just as covers for our 4000, 8000, 5000 and 5100 Series. To choose a cover, measure the top inside diameter and reference the list below.

7000 Standard-Weight 18-ga., 1 mm Aluminum

7006	5 3/4" ID x 7 1/2" OD x 1/4" Deep, For 6" ID pans (14.6 x 19 x 0.6 cm, for 15.2 cm pans) Cover only for 4006, 8006, 5006, 5106, Stacking Cover for DEP6, 2006, 9006
7007	6 3/4" ID x 8 1/2" OD x 1/4" Deep, For 7" ID pans (17.1 x 21.6 x 0.6 cm, for 17.8 cm pans) Cover only for 4007, 8007, 5007, 5107, Stacking Cover for DEP7, 2007, 9007
7008	7 3/4" ID x 9 1/2" OD x 1/4" Deep, For 8" ID pans (19.7 x 24.1 x 0.6 cm, for 20.3 cm pans) Cover only for 4008, 8008, 5008, 5108, Stacking Cover for DEP8, 2008, 9008
7009	8 3/4" ID x 10 1/2" OD x 1/4" Deep, For 9" ID pans (22.2 x 26.7 x 0.6 cm, for 22.9 cm pans) Cover only for 4009, 8009, 5009, 5109, Stacking Cover for DEP9, 2009, 9009
7010	9 3/4" ID x 11 1/2" OD x 1/4" Deep, For 10" ID pans (24.8 x 29.2 x 0.6 cm, for 25.4 cm pans) Cover only for 4010, 8010, 5010, 5110, Stacking Cover for DEP10, 2010, 9010
7011	10 3/4" ID x 12 1/2" OD x 1/4" Deep, For 11" ID pans (27.3 x 31.7 x 0.6 cm, for 27.9 cm pans) Cover only for 4011, 8011, 5011, 5111, Stacking Cover for DEP11, 2011, 9011
7012	11 3/4" ID x 13 1/2" OD x 1/4" Deep, For 12" ID pans (29.8 x 34.3 x 0.6 cm, for 30.5 cm pans) Cover only for 4012, 8012, 5012, 5112, Stacking Cover for DEP12, 2012, 9012
7013	12 3/4" ID x 14 1/2" OD x 1/4" Deep, For 13" ID pans (32.4 x 36.8 x 0.6 cm, for 33 cm pans) Cover only for 4013, 8013, 5013, 5113, Stacking Cover for DEP13, 2013, 9013
7014	13 3/4" ID x 15 1/2" OD x 1/4" Deep, For 14" ID pans (34.9 x 39.4 x 0.6 cm, for 35.6 cm pans) Cover only for 4014, 8014, 5014, 5114, Stacking Cover for DEP14, 2014, 9014
7015	14 3/4" ID x 16 1/2" OD x 1/4" Deep, For 15" ID pans (37.5 x 41.9 x 0.6 cm, for 38.1 cm pans) Cover only for 4015, 8015, 5015, 5115, Stacking Cover for DEP15, 2015, 9015
7016	15 3/4" ID x 17 1/2" OD x 1/4" Deep, For 16" ID pans (40 x 44.5 x 0.6 cm, for 40.6 cm pans) Cover only for 4016, 8016, 5016, 5116, Stacking Cover for DEP16, 2016, 9016
7017	16 3/4" ID x 18 1/2" OD x 1/4" Deep, For 17" ID pans (42.5 x 47 x 0.6 cm, for 43.2 cm pans) Cover only for 4017, 8017, 5017, 5117, Stacking Cover for DEP17, 2017, 9017
7018	17 3/4" ID x 19 1/2" OD x 1/4" Deep, For 18" ID pans (45.1 x 49.5 x 0.6 cm, for 45.7 cm pans) Cover only for 4018, 8018, 5018, 5118, Stacking Cover for DEP18, 2018, 9018



7016



SQUARE DEEP DISH PANS USA

Crafted from heavy-weight 14-ga., 1.5 mm aluminum, these straight-sided square pans can be perforated with the same round pattern used on our Perf Discs on pg. 388. Hard Coat Anodized 14-ga., 1.5 mm Aluminum not shown.

PAN DEPTH 1" (2.5 CM)

Pan size

6" Sq. (15.2 cm)
8" Sq. (20.3 cm)
10" Sq. (25.4 cm)
12" Sq. (30.5 cm)
14" Sq. (35.6 cm)
16" Sq. (40.6 cm)

Heavy-Weight
14-ga., 1.5 mm Aluminum

SQ610
SQ810
SQ1010
SQ1210
SQ1410
SQ1610

Hard Coat Anodized
14-ga., 1.5 mm Aluminum

HCSQ610
HCSQ810
HCSQ1010
HCSQ1210
HCSQ1410
HCSQ1610

PAN DEPTH 1 1/2" (3.8 CM)

Pan size

6" Sq. (15.2 cm)
8" Sq. (20.3 cm)
10" Sq. (25.4 cm)
12" Sq. (30.5 cm)
14" Sq. (35.6 cm)
16" Sq. (40.6 cm)

SQ615
SQ815
SQ1015
SQ1215
SQ1415
SQ1615

HCSQ615
HCSQ815
HCSQ1015
HCSQ1215
HCSQ1415
HCSQ1615

PAN DEPTH 2" (5.1 CM)

Pan size

6" Sq. (15.2 cm)
8" Sq. (20.3 cm)
10" Sq. (25.4 cm)
12" Sq. (30.5 cm)
14" Sq. (35.6 cm)
16" Sq. (40.6 cm)

SQ620
SQ820
SQ1020
SQ1220
SQ1420
SQ1620

HCSQ620
HCSQ820
HCSQ1020
HCSQ1220
HCSQ1420
HCSQ1620

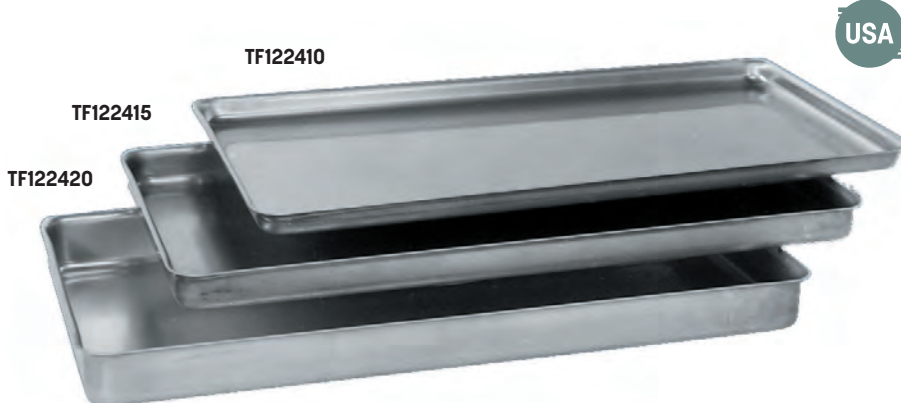

SQUARE SEPARATORS USA

Use these heavy-weight 14-ga., 1.5 mm aluminum separators as serving pans or stackable covers for any of our Square Deep Dish Pans.

SQ600 8 1/2" Sq. (20.3 cm)
for 6" (15.2 cm) pan

SQ800 10 1/2" Sq. (26.7 cm)
for 8" (20.3 cm) pan

SQ1000 12 1/2" Sq. (38.1 cm)
for 10" (25.4 cm) pan

SQ1200 14 1/2" Sq. (36.8 cm)
for 12" (30.5 cm) pan

SQ1400 16 1/2" Sq. (41.9 cm)
for 14" (35.6 cm) pan

SQ1600 18 1/2" Sq. (47 cm)
for 16" (40.5 cm) pan

Rectangular Deep Dish Pans USA

Made of heavy-weight 14-ga. aluminum, these rectangular pizza pans are designed for specialty pizzas. Feed the entire party with its two foot length and choice of depth.

Heavy-Weight 14-ga., 1.5 mm Aluminum

TF122410 24" L x 12" W x 1" H
(61 x 30.5 x 2.5 cm)

TF122415 24" L x 12" W x 1 1/2" H
(61 x 30.5 x 3.8 cm)

TF122420 24" L x 12" W x 2" H
(61 x 30.5 x 5.1 cm)

Hard Coat Anodized 14-ga., 1.5 mm Aluminum

HCTF122410 24" L x 12" W x 1" H
(61 x 30.5 x 2.5 cm)
(not shown)

HCTF122415 24" L x 12" W x 1 1/2" H
(61 x 30.5 x 3.8 cm)
(not shown)

HCTF122420 24" L x 12" W x 2" H
(61 x 30.5 x 5.1 cm)
(not shown)

Rectangular Hard Coat Anodized Aluminum Long Pans NEW

Create decadent, crispy crust on 2 - 3 sides of each piece with these heavy-weight, hard coat aluminum long pizza pans. Creates 3-6 equal 4" cuts.

- HCLP12** 12" L x 4" W x 1 5/8" H
(30.5 x 10.2 x 4.1 cm)
- HCLP16** 16" L x 4" W x 1 5/8" H
(40.6 x 10.2 x 4.1 cm)
- HCLP24** 24" L x 4" W x 1 5/8" H
(61 x 10.2 x 4.1 cm)

Sicilian-Style Hard Coat Anodized Aluminum Pans NEW

Now you can bake pizza just like Nonna used to make! Manufactured of heavy-duty hard coat aluminum, our Sicilian pizza pans are available in all the most popular square and rectangular sizes. The tapered 1 inch depth and crisp angled corners provide efficient cooking, easy clean-up and space-saving nestability for storage.

- HCSS12** 12" Sq. x 1" H
(30.5 x 2.5 cm)
- HCSS14** 14" Sq. x 1" H
(35.6 x 2.5 cm)
- HCSS16** 16" Sq. x 1" H
(40.6 x 2.5 cm)
- HCSS1411** 14" L x 10" W x 1" H
(35.6 x 25.4 x 2.5 cm)
- HCSS1812** 18" L x 12" W x 1" H
(45.7 x 30.5 x 2.5 cm)
- HCSS248** 24" L x 8" W x 1" H
(61 x 20.3 x 2.5 cm)
- HCSS2416** 24" L x 16" W x 1" H
(61 x 40.6 x 2.5 cm)

Detroit-Style Hard Coat Anodized Aluminum Pans and Flexible Server NEW

Detroit-style pizza lovers, rejoice! These extra-deep pans are the secret to baking Motown-worthy pies every time. Plus, the accompanying flexible server is perfect for getting every bit of buttery crust.

- FS9** Flexible Server
9" L x 4 1/4" W
(22.9 x 10.8 cm)
- HCDS108** 10" L x 8" W x 2 3/8" H
(25.4 x 20.3 x 6 cm)
- HCDS1410** 14" L x 10" W x 2 1/2" H
(35.6 x 25.4 x 6.4 cm)
- HCDS1712** 17" L x 12" W x 2 3/4" H
(43.2 x 30.5 x 7 cm)

Aluminium Lids

- DSP11** Fits HCDS108, 11 1/2" L x 9 1/2" W
(29.2 x 24.1 cm)
(not shown)
- DSP15** Fits HCDS1410, 15 1/2" L x 11 1/2" W
(39.4 x 29.2 cm)
- DSP18** Fits HCDS1712, 18 1/2" L x 13 1/2" W
(47 x 34.3 cm)



Shown with FS9 server, OWBB1 crate and CSC4CL sauce cup





PS1116 shown with ADH10 dredges, BEE319 and BEE317 shakers

ALL OF OUR STONES ARE FDA-APPROVED



PS1416



PS125



PS1575





PSS15



PSS12

Deluxe Pizza Stones

Perfect for spaces where hearth baking isn't possible, these stones are designed with ideal thickness and porosity for heat retention. Made of cordierite, a lead-free firebrick material.

- PS125** Round
 12 1/2" Dia. x 3/8" H (31.8 x 0.6 cm)
- PS1575** Round
15 3/4" Dia. x 7/8" H (40 cm x 2.2 cm)
- PSS12** Square
 12" Sq. x 1/4" H (30.5 x 1 cm)
- PSS15** Square
 15" Sq. x 1/2" H (38.1 x 1.3 cm)
- PS1116** Rectangular
16" L x 11" W x 3/4" H (40.6 x 27.9 x 1 cm)
- PS1416** Rectangular
16" L x 14" W x 7/8" H (40.6 x 35.6 x 2.2 cm)



STONE13

CAN ALSO KEEP PIZZAS WARM
IN HEATED DISPLAY CASES

Pizza Stones  

These ceramic baking stones create a light, crispy crust by distributing heat evenly and efficiently.

STONE13 Round
13" Dia. x 3/8" H (33 x 1 cm)

STONE12 Rectangular
15" L x 12" W x 3/8" H (38 x 30.5 x 1 cm)

STONE15 Round
15" Dia. x 3/8" H (38 x 1 cm)

STONE14 Rectangular
15" L x 14" W x 3/8" H (38 x 35.6 x 1 cm)



STONE12



STONE15



STONE14

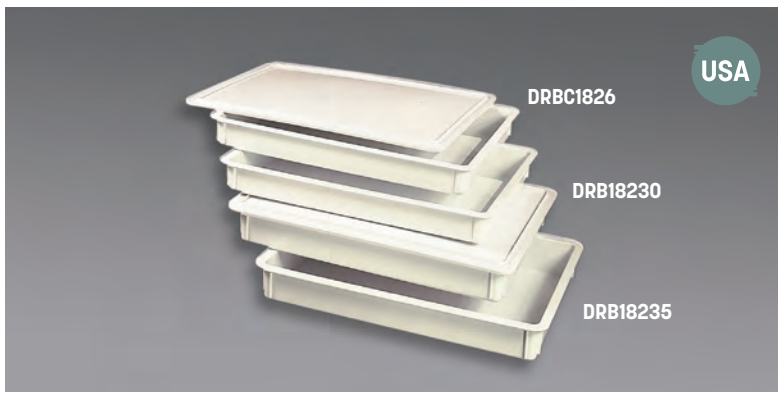

Standard Dough Boxes ^{USA}

Tough ABS construction with reinforced sides, corners and edges. Stacks securely. Choose from depths of 3" (7.62 cm) and 3 1/2" (8.9 cm). Cover fits both. Dishwasher-safe.

DRB18230 18" L x 26" W x 3" H
(45.7 x 66 x 7.6 cm)

DRB18235 18" L x 26" W x 3 1/2" H
(45.7 x 66 x 8.9 cm)

DRBC1826 Cover for Dough Pans

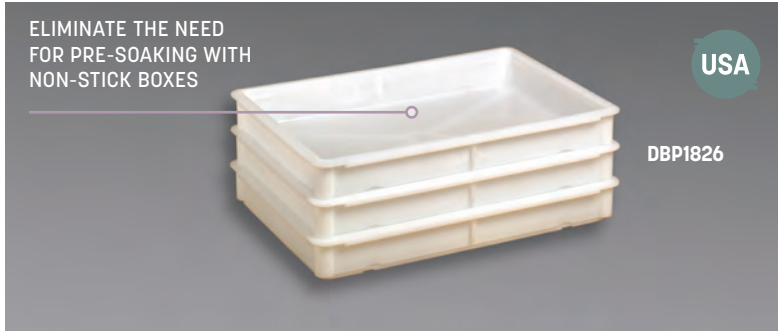

Heavy-Duty Dough Box ^{USA}

Our premium dough boxes are manufactured from tough Teflon® copolymer for the ultimate in non-stick. Cross-stack lugs enable fast and secure cross-stacking. Interchangeable with most other dough boxes.

DBP1826 18" L x 26" W x 3 1/8" H
(45.7 x 66 x 7.9 cm)

Deluxe Anodized Aluminum Dough Pans ^{USA}

Constructed from heavy-weight 14-ga., 1.5 mm tempered aluminum in a secure, self-stacking design for easy storage. Cleans easily and refrigerates quickly. Eastern pan stacks with pans of similar shape.

Small Straight-Sided Stacking ^{USA}

DRPS5725 7" ID x 2 1/2" H
(17.8 x 6.4 cm) 32 oz. (0.9 L) capacity

7007 Cover for DRPS5725

DRPS5825 8" ID x 2 1/2" H
(20.3 x 6.4 cm) 40 oz. (1.2 L) capacity

7008 Cover for DRPS5825

Standard Straight-Sided Stacking ^{USA}

DRP774 7 7/8" OD x 7 1/4" ID x 2 3/8" H
(20 x 18.4 x 6 cm) 40 oz. (1.2 L) capacity

7007 Cover for DRP774

DRP884 9" OD x 8 3/8" ID x 3 3/8" H
(22.9 x 21.3 x 8.6 cm) 80 oz. (2.4 L) capacity

7008E Cover for DRP884

Eastern Stacking

DRPE800 8" OD x 7 3/8" ID x 2 5/8" H
(20.3 x 18.7 x 7.6 cm) 48 oz. (1.41 L) capacity

7007E Cover for DRPE800

DRPE878 8 7/8" OD x 8 1/4" ID x 3 1/4" H
(22.5 x 20.9 x 8.9 cm) 96 oz. (2.8 L) capacity

7008E Cover for DRPE878



Rolling Pins and Pie Rollers

Whatever your preferred style of roller is, American Metalcraft has you covered.

- PR18** Wood
1 1/4" Dia. x 18" L
(3.18 x 45.7 cm)
- PRP500** Stainless Steel
1 3/4" Dia. x 5 1/2" W x 8 3/4" L
(4.4 x 13.9 x 22.2 cm)
- RP5713** Aluminum
13" W (33 cm)
(not shown)
- RP5715** Aluminum
15" W (38.1 cm)
(not shown)
- WRPC5713** Wood
13" W (33 cm)
(not shown)
- RP5718** Aluminum
18" W (45.7 cm)
- WRPC5715** Wood
15" W (31.8 cm)
(not shown)
- WRPC5718** Wood
18" W (45.7 cm)
- WRPCHARDWARE** 2 Extra Handles each,
Stainless Steel End Caps
and Nylon Bearings



Dough Cutters and Scrapers

Features stainless steel blade and wood or plastic handle.

- DS6704** Wood Handle
4 1/2" H (11.4 cm)
- DS6706** Wood Handle
6" H (15.2 cm)
- DSP6705** Plastic Handle
4 1/2" H (11.4 cm)

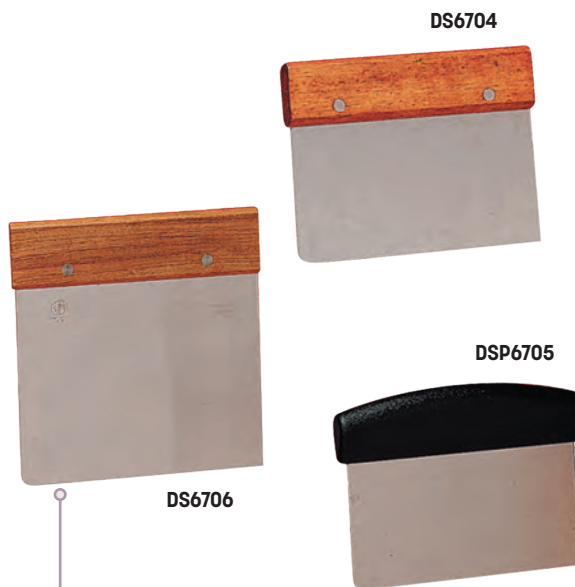

ROUNDED CORNER SCRAPES CLEAN
WITHOUT EXCESSIVE SCRATCHING

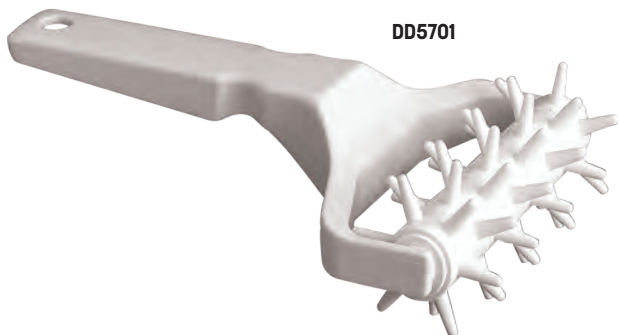

Heavy-Duty Plastic Roller Docker

Individual wheels with plastic points spin independently on a stainless steel axle.

DD5274 Half-Size Plastic Docker
Plastic Handle
3 1/2" W x 8 3/4" L (8.9 x 22.2 cm)

DD5705 Full-Size Plastic Docker
Aluminum Handle
5 1/2" W x 8 3/4" L (13.9 x 22.2 cm)

DDW5705 Extra Wheels

Ten-Wheel Casted Handle

Dough Docker

Features a one-piece, heavy-duty cast aluminum ergonomic handle and interchangeable ten-piece plastic wheel base.

DDCH7755 6" W x 7 1/2" L (15.2 x 19.1 cm)

DDW5705 Extra Wheels

Casted Handle Dough Docker

One-piece cast aluminum ergonomic handle for great durability. Features 3/8" (0.9 cm) stainless steel pins embedded in plastic roller.

DDCH7744 6" W x 7 1/2" L (15.2 x 19.1 cm)

All-Plastic Dough Docker

One-piece plastic core features 3/8" (1.5 cm) long pins. Dishwasher-safe.

DD5701 Plastic Docker

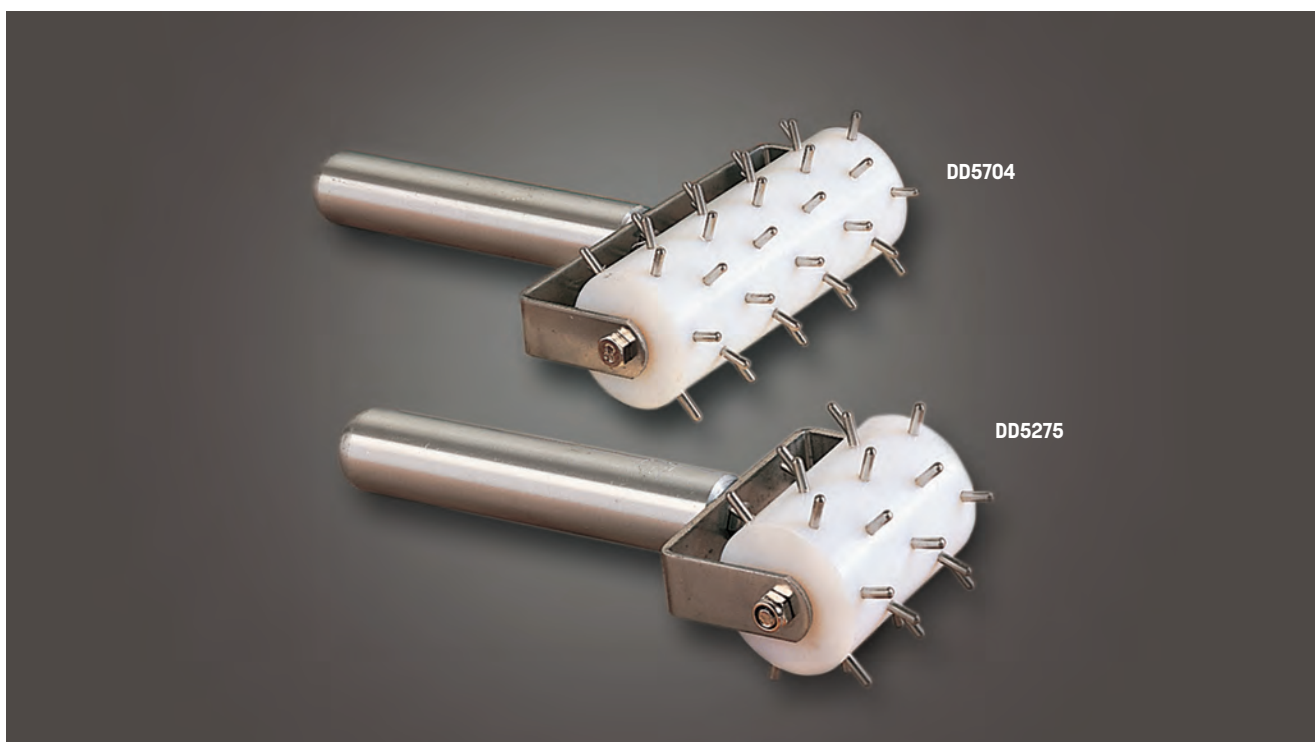

DD5704

DD5275

Heavy-Duty Roller Dockers

Stainless steel pins are permanently embedded in a plastic core. Crafted with stainless steel axle and sanitary solid aluminum handle.

DD5275 Half-Size Plastic Docker
2 ¾" W x 1 ¾" Dia. Barrel
(7 x 4.4 cm)

DD5704 Full-Size Plastic Docker
5" W x 1 ¾" Dia. Barrel
(12.7 x 4.4 cm)

Long-Pin Docker

Unit made with two sets of interlocking plastic pins.

DD5703 Plastic Pin Docker 7/8" L Pins (2.2 cm)
3 ½" W x 8 ½" Overall
(8.9 x 21.6 cm)

DDW5703 Extra Wheels



DD5703



HPP16



HPP7

Heart-Shaped Aluminum Pizza Pans

These playful pans aren't just for pizza. Share the love with cakes, brownies and oversized cookies too.

HPP7 7" W x 1 1/2" Deep (17.8 x 3.8 cm)

HPP16 16" W x 1 1/2" Deep (40.6 x 3.8 cm)



EM199

Mini Stainless Steel Number Tents

Made of dishwasher-safe, high-heat-resistant stainless steel, these 1" square, double-sided embossed number tents make table service easy as pie.

EM199 Nos. 1-99

EM1200 Nos. 1-200

EM200 Nos. 201-400

EM400 Nos. 401-600

Super Heavy-Duty Pan Grippers

An extra-durable alternative to our standard Pan Grippers, these pieces are 50% heavier. Use HDD94 with shallow pans such as our CAR, DEP and 4000 Series. Use HDS95 with our 3800, 5000, 5100, 8000 and 9000 Series pans.

HDD94 For Shallow Pans

HDS95 For Deep Pans



HDS95

HDD94

50% HEAVIER THAN
STANDARD PAN GRIPPERS

Pan Grippers

Cast Aluminum Pan Gripper

Reinforced bottom curves provide better grip. Spring-loaded for easy release of pan. Designed for use with DEP, 3800, 4000, 5000, 5100, 8000 and 9000 Series pans.

G9595 8 1/8" L (20.6 cm)

Nylon Pan Gripper

Dishwasher-safe, high-heat-resistant. Designed for use with DEP, 3800, 4000, 5000, 5100, 8000 and 9000 Series pans.

N9494 8 1/4" L (21 cm)

Nickel-Plated Pan Grippers

Crafted from heavy-tempered steel. Use 9525 with shallow pans such as our CAR, DEP and 4000 Series. Use 19540 with our 3800, 5000, 5100, 8000 and 9000 Series pans.

9525 For Shallow Pans

19540 For Deep Pans



USA

N9494

G9595

9525

19540

SHAKER TOPS AND BOTTOMS

With glass bodies and a variety of stainless steel tops, these shakers feature eye-catching contemporary designs.

2 oz. Glass Contemporary Shakers

Measures 2" Dia. x 3 1/8" H (5.1 x 7.9 cm).

GLACT2 Shaker w/ Cheese Top

GLAST2 Shaker w/ Slotted Top

GLADT2 Shaker w/ Adjustable Dial Top

GLBASE Shaker Base Only

2 oz. Replacement Tops

CT2 Cheese Round

ST2 Spice Slotted

DT2 Adjustable Dial Top

CAP2 Plastic Cover for Top

6 oz. Glass Contemporary Shakers

Measures 2 3/8" Dia. x 4 1/2" H (6 x 11.4 cm).

4406 Shaker w/ Cheese Top

4407 Shaker w/ Slotted Top

GLADT6 Shaker w/ Adjustable Dial Top

GLA600 Shaker Base Only

6 oz. Replacement Tops

4406T Cheese Round

4407T Spice Slotted

DT6 Adjustable Dial Top

CAP25 Plastic Cover for Top

Vintage Collection Square Glass Shakers

Part of our Vintage Collection, these cheese and spice shakers feature stainless steel caps and are dishwasher-safe. Each 6 oz. (177.4 mL) shaker measures 2 5/8" Sq. x 3 3/4" H (6.7 x 9.5 cm).

GSC6 Shaker w/ Cheese Top

GSS6 Shaker w/ Slotted Top

GSD6 Shaker w/ Adjustable Dial Top



CHECK OUT OUR MATCHING
VINTAGE S&P SHAKERS
ON PG. 135



6 oz. Swirl Jar Shakers

Our take on classic pizzeria styling. 6 oz. (177.4 mL) capacity. 2 5/8" Dia. x 3 1/2" H (6.7 x 8.9 cm).

Glass

- 3306** Shaker w/ Cheese Top
- 3307** Shaker w/ Spice Top

PET

- LX306** Shaker w/ Cheese Top (not shown)
- LX307** Shaker w/ Spice Top (not shown)

Replacement Shaker Tops

6 oz. and 8 oz. Tops

- 3307T** Small Spice Slotted
- 3306T** Cheese w/ Small Round Holes

12 oz. Tops

- 3312T** Cheese w/ Large Round Holes
- 3316T** Sugar Flat Top
- 3317T** Large Spice Slotted
- 3319T** Cheese w/ Extra Large Holes
- 3318T** Dredge w/ Small Round Holes



8 oz. Glass Shakers

Ideal for condiments such as red pepper, oregano and parmesan cheese. 8 oz. (236.6 mL) capacity. 2 3/4" Dia. x 3 7/8" H (7 x 9.8 cm).

- 3308** Shaker with Cheese Top
- 3309** Shaker with Spice Top



Mini Glass Shakers and Caddy

This stainless steel rack and its matching glass shakers are a fraction of the size of regular shakers.

MGLA3 Base, 2 oz. (59.1 mL)
1 5/8" Dia. x 3 5/8" H
(4.1 x 9.2 cm)

MCADDY Caddy
4 1/2" L x 2 1/4" W x 5 1/2" H
(11.4 x 5.7 x 14 cm)

MGLCS Set
(Includes Caddy and Cheese and Spice Shakers)

Replacement Mini Lids

- M30SP** Salt and Pepper
- M312T** Cheese
- M316T** Sugar Top Flap
- M317T** Spice

MINIATURE DESIGN IS EXTRA EASY TO CARRY



6 oz. Glass Beehive Shakers

This 6 oz. (177.4 mL) beehive shaker features a charming pear-shaped design.

- BEE606** Shaker w/ Cheese Top
- BEE607** Shaker w/ Spice Top
- BEE600** Shaker Base Only

12 oz. Glass Beehive Shakers

These stylishly ridged beehive shakers measure 3" Dia. x 5 3/8" H (7.6 x 13.7 cm).

- BEE312** Shaker w/ Cheese Top
- BEE316** Shaker w/ Sugar Top
- BEE317** Shaker w/ Spice Top
- BEE318** Shaker w/ Dredge Top
- BEE319** Shaker w/ Extra Large Holes Cheese Top
- BEE300** Shaker Base Only



PAIR WITH OTHER PIECES FROM OUR BEEHIVE LINE (PG. 132)





12 oz. Classic Shakers

These 12 oz. (354.9 mL) capacity shakers have a standard straight-sided fluted shape and are stain-proof and dishwasher-safe. The SAN plastic shakers are nearly indestructible. Sugar top has a self-closing flap. 3" Dia. x 5 3/8" H (7.6 x 13.7 cm).

Glass

- GLA312** Shaker w/ Cheese Top
- GLA316** Shaker w/ Sugar Top
- GLA317** Shaker w/ Spice Top
- GLA318** Shaker w/ Dredge Top
- GLA319** Shaker w/ Extra Large 1/4" Holes Cheese Top
- GLA300** Shaker Base Only

SAN Plastic

- SAN312** Shaker w/ Cheese Top
- SAN316** Shaker w/ Sugar Top
- SAN317** Shaker w/ Spice Top
- SAN318** Shaker w/ Dredge Top
- SAN319** Shaker w/ Extra Large 1/4" Holes Cheese Top
- SAN300** Shaker Base Only



12 oz. Tapered Plastic Shakers

These shakers feature heavy-duty plastic bases and stainless steel tops. Odorless and dishwasher-safe. 3" Dia. x 5 3/8" H (7.6 x 13.7 cm).

- 3312** Shaker w/ Cheese Top
- 3316** Shaker w/ Sugar Top
- 3317** Shaker w/ Spice Top
- 3318** Shaker w/ Dredge Top
- 3319** Shaker w/ Extra Large 1/4" Holes Cheese Top
- 3300** Shaker Base Only

Stainless Steel Shakers

In cool brushed stainless steel, these shakers feature fine or coarse holes for different seasonings. 16 oz. (473.2 mL) capacity. 3" Dia. x 7" H (7.6 x 17.8 cm).

- TSF7** Shaker w/ Fine Holes
- TSC7** Shaker w/ Coarse Holes





DRCKC7

DRCKC6 shown with 2212 wood peel and MGLCS mini glass shakers and caddy

Square and Rectangular Stands

Silver

DRCKC7 Square
7" Sq. Top x 9" Sq. Bottom x 7" H
(17.8 x 22.9 x 17.8 cm)

DRCKC6 Rectangular
9" L x 6" W Top
x 11" L x 8" W Bottom x 7" H
(22.9 x 15.2 x 27.9 x 20.3 x 17.8 cm)

Black

DRCKB7 Square
7" Sq. Top x 9" Sq. Bottom x 7" H
(17.8 x 22.9 x 17.8 cm)

DRCKB6 Rectangular
9" L x 6" W Top
x 11" L x 8" W Bottom x 7" H
(22.9 x 15.2 x 27.9 x 20.3 x 17.8 cm)



DRCKB6 shown with FSLT14 faux slate platter and HMMJ4 mini apothecary jar

DRCKB7

Square Pizza Paper

In your choice of three classic styles.
1000 16" (40.6 cm) sheets per pack.

PPRW1616 White

PPCH4N Natural

PPRN1616 Newspaper



PPRN1616

PPCH4N

PPRW1616



SDRCK4 shown with TP14 tray and MGLA3 shakers

SDRCK shown with TP14 tray and BEE312 and BEE317 shakers



Shown with 3218 wood peel and BEE319 shakers

BUS309

BUS312

Round Pizza Stands

SDRCK4 7 1/2" Top Dia. x 9 5/8" Bottom Dia. x 4" H (19.1 x 24.4 x 10.2 cm)

SDRCK 7 1/2" Top Dia. x 9 5/8" Bottom Dia. x 7 3/8" H (19.1 x 24.4 x 18.7 cm)

Universal Pizza Stands

Black

BUS309 9" L x 8" W x 7" H (22.9 x 20.3 x 17.8 cm)

BUS312 12" Sq. x 7" H (30.5 x 17.8 cm)

Chrome-Plated

190039 9" L x 8" W x 7" H (22.9 x 20.3 x 17.8 cm)

1900312 12" Sq. x 7" H (30.5 x 17.8 cm) (not shown)

Slip-Stop Sleeves

These inconspicuous black plastic sleeves keep pizza trays and plates in place. Also prevents stand from sliding on table.

3SSS 3-Pack
4" L x 1/4" ID x 1/16" Thick
(10.2 x 0.6 x 0.2 cm)
Fits SDRCK4, SDRCK, 190039, 1900312, BUS309, BUS312, LWUS779, SSUS1, LWUSR

4SSS 4-Pack
4 1/8" L x 1/4" ID x 1/16" Thick
(10.5 x 0.6 x 0.2 cm)
Fits PSS77, DPS797



190039 shown with HC90162 pan (Slip-stop sleeves sold separately)



LWUS779

SSUS1

LWUSR shown with TP12 pan

Shown with PC7400 pizza cutter and 4407 shaker

Contempo™ Swirl Pizza Stands

These stylishly versatile stands can be flipped over to accommodate different sizes of trays.

LWUSR Red
7" Top Dia. x 9" Bottom Dia. x 7" H
(17.8 x 22.9 x 17.8 cm)

LWUS779 Black
7" Top Dia. x 9" Bottom Dia. x 7" H
(17.8 x 22.9 x 17.8 cm)

SSUS1 Stainless Steel
7" Top Dia. x 9" Bottom Dia. x 7" H
(17.8 x 22.9 x 17.8 cm)

Ironworks Pizza Stands

DPS797 Drum
7" Top Dia. x 9" Bottom Dia. x 7" H
(17.8 x 22.9 x 17.8 cm)

PSS77 Black Square Scroll
7" Sq. x 9" H (17.8 x 22.9 cm)

Black Iron Pizza Stand

Serve two pizzas at a time without taking up valuable table space with this two-tiered piece from our Ironworks Collection.

TLSP1219 19 3/8" L x 11 3/4" W x 12 3/8" H
(49.2 x 29.9 x 31.4 cm)

Jumbo Stainless Steel Soup Cans

Whether you use them as risers or condiment holders, these rustic cans offer versatile solutions with a memorable twist.

CSM40 40 oz. (1.2 L)
6 1/4" Dia. x 3" H (15.9 x 7.6 cm)

CSM2 2 qt. (1.8 L)
5 1/4" Dia. x 6" H (13.3 x 15.2 cm)

CSM3 3 1/4 qt. (3.1 L)
6 1/4" Dia. x 7" H (15.9 x 17.8 cm)



PSS77 shown with HA5012 pan

DPS797 shown with TP14 pan



DESIGNED FOR MINIMAL FOOTPRINT

TLSP1219 shown with TP15 pan



CSM40 shown with 4406 and GLADT6 shakers

CSM2 shown with OWP13 olive wood peel

CSM3

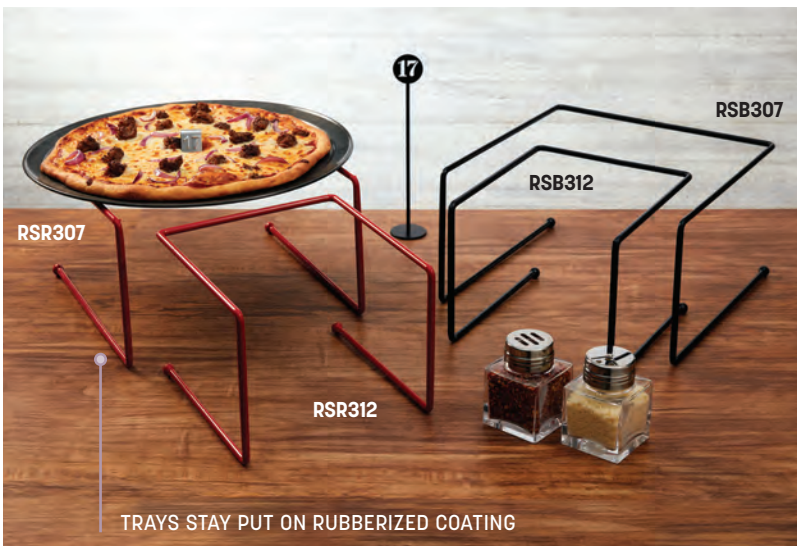

Rubberized Universal Stands

Our stylishly minimalist pizza stands, now wrapped in slide-resistant rubber. What's not to love?

Red

RSR312 9" L x 8" W x 7" H (22.9 x 20.3 x 17.8 cm)

RSR307 12" Sq. x 7" H (30.5 x 17.8 cm)

Black

RSB312 9" L x 8" W x 7" H (22.9 x 20.3 x 17.8 cm)

RSB307 12" Sq. x 7" H (30.5 x 17.8 cm)

Black Rubberized Stands

Tired of tracking down rubber stoppers to keep your pizza pans in place? These ingenious stands have the rubber built in. Plus, each of these contemporary wire-frame designs are reversible.

Round

RSRB4 7 1/2" Dia. Top x 9 5/8" Bottom Dia. x 4" H (19.1 x 24.4 x 10.2 cm)

RSRB 7 1/2" Dia. Top x 9 5/8" Bottom Dia. x 7 3/8" H (19.1 x 24.4 x 18.7 cm)

RSR10 8 3/8" Dia. Top x 9 7/8" Bottom Dia. x 11 3/4" H (21.3 x 25.1 x 29.8 cm)

Rectangular

RSRB3 9" L x 6" W Top x 11" L x 8" W Bottom x 3 1/2" H (22.9 x 15.2 x 27.9 x 20.3 x 8.9 cm)

RSRB7 9" L x 6" W Top x 11" L x 8" W Bottom x 7" H (22.9 x 15.2 x 27.9 x 20.3 x 17.8 cm)

Square

RSSB3 7" Sq. Top x 9" Sq. Bottom x 3 1/2" H (17.8 x 22.9 x 8.9 cm)

RSSB7 7" Sq. Top x 9" Sq. Bottom x 7" H (17.8 x 22.9 x 17.8 cm)

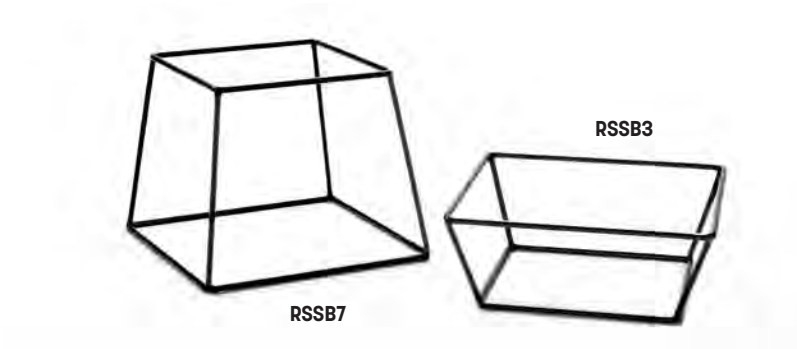
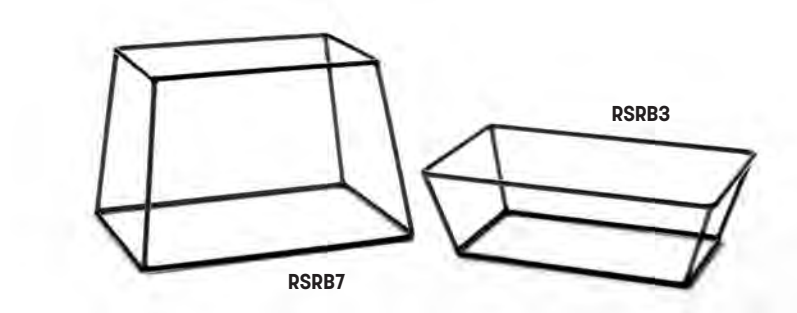

Ceramic Pizza Trays

These ceramic trays add a touch of old-world charm to pizza presentation. Available in four sizes to fit most standard pizzas.

CERAM12 12" Dia. (30.5 cm)

CERAM14 14" Dia. (35.6 cm)
(not shown)

CERAM16 16" Dia. (40.6 cm)

CERAM18 18" Dia. (45.7 cm)

Onyx Galvanized Wide Rim Pans

The days of using a standard aluminum pan for serving are over. You now have options! These dark galvanized pans are perfect for anything from pizza to burritos.

GTP10 10" Dia. x 3/8" H (25.4 x 1 cm)

GTP12 12" Dia. x 3/8" H (30.5 x 1 cm)

GTP14 14" Dia. x 3/8" H (35.6 x 1 cm)

GTP16 16" Dia. x 3/8" H (40.6 x 1 cm)

GTP18 18" Dia. x 3/8" H (45.7 x 1 cm)

Melamine Pizza Plates NEW

Serve up your favorite pie on these versatile, durable and washable melamine pizza plates. A sleek way to plate up any slice!

MTP10 10" Dia. x 3/4" H (25.4 x 1.9 cm)

MTP12 12" Dia. x 1 1/8" H (30.5 x 2.9 cm)

MTP14 14" Dia. x 1 1/8" H (35.6 x 2.9 cm)

MTP16 16" Dia. x 1 1/8" H (40.6 x 2.9 cm)

MTP18 18" Dia. x 1 1/8" H (45.7 x 2.9 cm)





DOUBLES AS
CHEESE GRATER

PSG127

PS127



PL147

PLP147

MINI BLADES ARE IDEAL FOR SMALL PIZZAS
AND OVEN-BAKED SANDWICHES



Shown with GLACT2
and GLAST2 shakers
and GTP14 pan

PSD10

Heavy-Duty Pizza Servers

Pizza anyone? These heavy-duty stainless steel servers are able to stand up to your largest slice. The perforated server even doubles as a cheese grater for a little extra topping.

PSG127 Perforated Server/Grater
7" L x 4 3/4" W Blade, 12 1/8" L Overall
(17.8 x 12.1, 30.8 cm)

PS127 Server
7" L x 4 3/4" W Blade, 12 1/8" L Overall
(17.8 x 12.1, 30.8 cm)

Mini Pizza Peels

The ideal size for personal sized pizzas and oven-baked subs. These heavy-duty stainless steel peels are strong enough to hold your heaviest pie. Perfect for conveyer ovens.

PL147 Stainless Steel
7 1/4" W x 9 5/8" L Blade, 14 3/4" L Overall
(18.4 x 24.4, 37.5 cm)

PLP147 Perforated Stainless Steel
7 1/4" W x 9 5/8" L Blade, 14 3/4" L Overall
(18.4 x 24.4, 37.5 cm)

Pizza Scissors/Turner

Pizza-lovers, rejoice! These innovative server-scissors can both cut and serve even the heartiest deep-dish pies. With a rubberized handle for comfortable grip and detachable construction for easy cleaning, this is a must-have tool for pizzerias across the globe.

PSD10 10 5/8" L x 3 1/2" W x 3/4" H
(26.9 x 8.9 x 1.9 cm)

Pizza Servers

Each of these practical tools features a stainless steel blade, perfect for both square- and triangle-sliced pizzas.

19006 Stainless Steel Pizza Server
with Wood Handle
5" L x 2 1/2" W x 1 1/2" Blade, 10" Overall
(12.7 x 6.3 x 3.8 cm, 26.7 cm)

PS10 Stainless Steel Turner
with Plastic Handle
3 5/8" L x 1 7/8" W Blade, 10" Overall
(9.2 x 4.8 cm, 25.4 cm)

PS196 Stainless Steel Pizza Server
with Dark Brown Handle
5" L x 2 1/2" W x 1 1/2" Blade, 10" Overall
(12.7 x 6.3 x 3.8 cm, 26.7 cm)



19006

PS196

PS10



Plastic-Handled Pizza Cutters

Heavy-duty one-piece molded plastic handles, stainless steel wheels.

- PPC2** Wheel w/ Black Handle, 2 ¾" Dia. (7 cm)
- PCW2** Blade for PPC2
- PPC4** Wheel w/ Black Handle, 4" Dia. (10.2 cm)
- PIZW1** Wheel w/ White Handle, 4" Dia. (10.2 cm)
- PIZR2** Wheel w/ Red Handle, 4" Dia. (10.2 cm)
- PIZG3** Wheel w/ Green Handle, 4" Dia. (10.2 cm)
- PCW4** Blade for PPC4, PIZW1, PIZR2, PIZG3
- PPC5** Wheel w/ Black Handle, 5" Dia. (12.7 cm)
- PCW5** Blade for PPC5
- PPCHARDWARE** Replacement Axle Assembly, w/ Screw Bushing and Lock Nut



Aluminum-Handled Pizza Cutters

Simple and classic, this cutter features a heavy cast aluminum handle with a stainless steel wheel.

- APC2** Wheel, 2 5/8" Dia. (6.7 cm)

Wood-Handled Pizza Cutters

Features sanitary stainless steel wheels, rust-proof guards and wooden handles.

- PC7250** Wheel, 2 ½" Dia. (6.3 cm)
- PC7400** Wheel, 4" Dia. (10.2 cm)



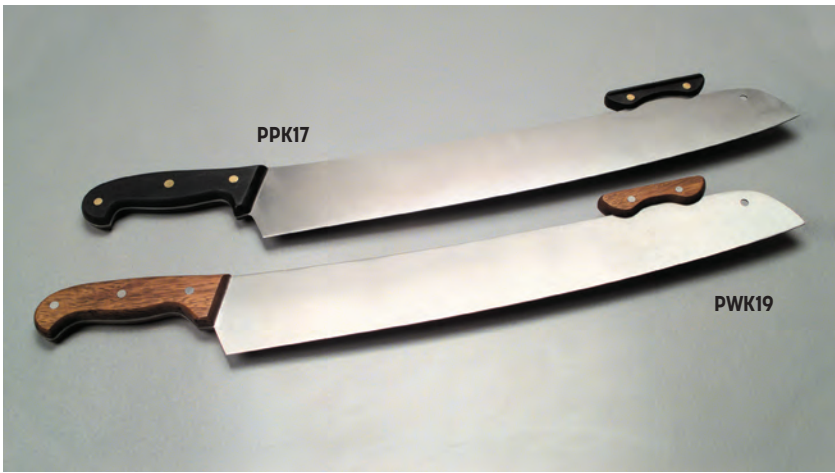

Pizza Knives

These full-tang knives feature stainless steel blades and double handles so you can cut safely and confidently.

PPK17 POM Handle
18" L Blade (45.7 cm)

PWK19 Wood Handle
18" L Blade (45.7 cm)

Pizza Rocker Knives

In addition to cutting pizzas, these stainless steel blades can be used to chop ingredients.

PRS14 14" L (35.6 cm)

PRS22 22" L (55.9 cm)

PKR20 20" L x 4 3/4" H Blade
21 1/2" L Overall Black Handle
(50.8 x 12.1, 54.6 cm)



Multi-Wheel Cutter

Take the guesswork out of slicing with this adjustable six-bladed cutter. Measures 2 1/2" x 9 1/2" (6.4 x 24.1 cm) when closed, and 24 1/2" x 9 1/2" (62.2 x 24.1 cm) when open. Distance between 2" parallel wheels can range from 3/4" to 4 3/4" (1.9 x 12.1 cm).

MWPC6X2 Six-Blade Cutter



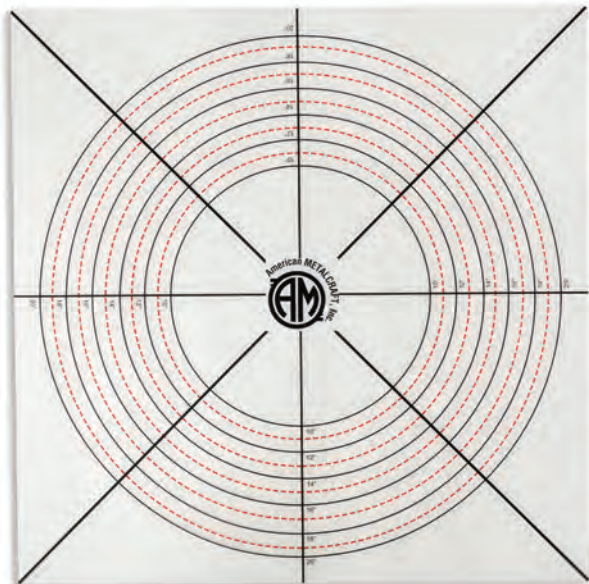

MPNS



MPCUT4

Non-Slip Pizza Cutting Mat

MPNS 22" Sq. x 1/8" H (55.9 x 0.32 cm)

Pizza Slice Cutting Guide USA

Made of NSF and USDA-listed material and marked in food-safe, FDA-approved ink, these pizza guide cutting boards are smart and durable.

MPCUT4 Board with Markings for 4-Slice or 8-Slice
20" Sq. x 1/4" H (50.8 x 0.6 cm)

MPCUT6 Board with Markings for 6-Slice
20" Sq. x 1/4" H (50.8 x 0.6 cm)
(not shown)

Pizza Bubble Poppers

Choose from wood, all-aluminum and red rubber grips.

SBP30 Red Rubber Grip
30" L (76.2 cm)

BP39 Wood Handle
39" L (99 cm)

19009 Aluminum
43" L (109.2 cm)

BP51 Wood Handle
51" L (129.5 cm)

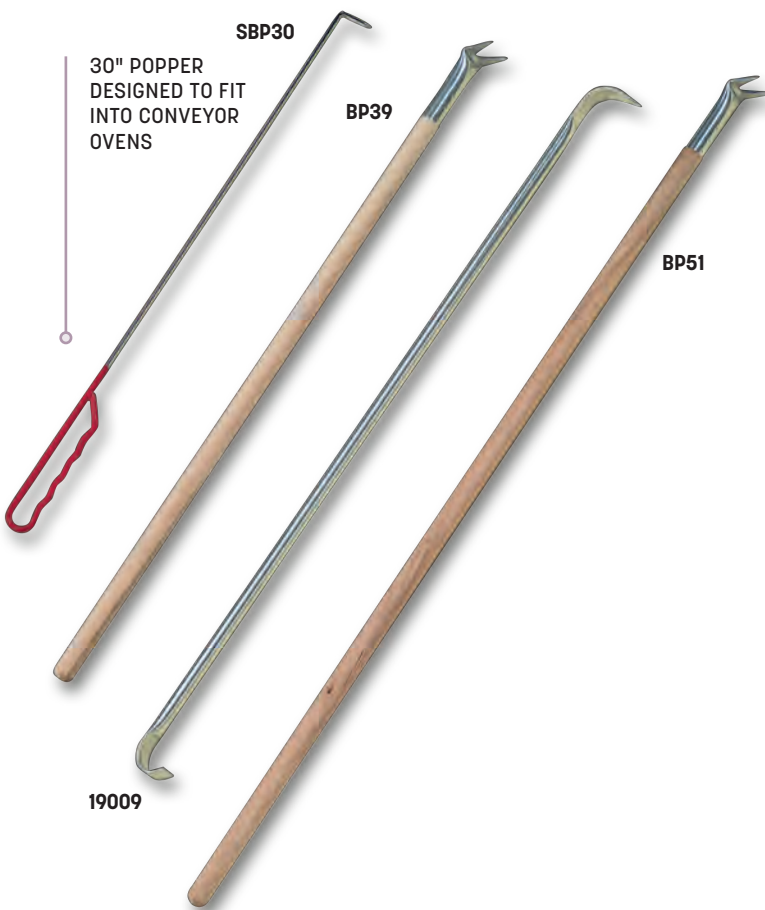

19009



19029
shown with
HCDEP12 and
TP12 pans

19030
shown with
ADEP12 and
HCDEP12 pans

19033
shown with
HC90182 and
HA2018 pans

19024
shown with
18712, and
18717 pizza
screens



19107

Shown with (3)
18714 pizza screens

Pizza Racks

- 19030** Standard for Pans up to 2 ¼" (5.08 cm) Deep
10" - 17" (25.4 - 43.2 cm) Dia.
11 Shelves with 2 ½" (6.4 cm) between with 12" (30.5 cm) Base
- 19029** Standard for Pans up to 1 ¼" (3.18 cm) Deep
10" - 17" (25.4 - 43.2 cm) Dia.
15 Shelves with 1 ⅜" (3.5 cm) between with 12" (30.5 cm) Base

- 19024** Standard for Pans up to ½" (1.2 cm) Deep
10" - 17" (25.4 - 43.2 cm) Dia.
24 Shelves with ¾" (1.9 cm) between with 12" (30.5 cm) Base
- 19033** Over Sized for Pans up to 2 ¼" (5.1 cm) Deep
16" - 23" (40.6 - 58.4 cm) Dia.
10 Shelves with 2 ½" (6.4 cm) between with 16" (40.6 cm) Base

Wall-Mounted Pizza Rack

- 19107** Wall-Mountable with Seven Tiers
12" L x 10" W x 15" H
(30.5 x 25.4 x 38.1 cm)
- 19104** 4 Brackets and 8 Screws for 19107

Aluminum Small Blade Peels  

9" x 11" (22.9 x 28 cm) Blade

- 2109** 21" L Overall (53.3 cm)
- 3209** 32 ½" L Overall (82.6 cm)
- 4909** 49" L Overall (124.5 cm)
- 6109** 61" L Overall (155 cm)

Aluminum Medium Blade Peels  

12" x 14" (30.5 x 35.6 cm) Blade

- 2512** 26" L Overall (66 cm)
- 3512** 35 ½" L Overall (90.2 cm)
- 5212** 52" L Overall (132.1 cm)
- 6412** 64" L Overall (162.6 cm)

Aluminum Large Blade Peels  

14" x 16" (35.6 x 40.6 cm) Blade

- 2814** 28" L Overall (71.1 cm)
- 3714** 37" L Overall (94 cm)
- 5414** 54" L Overall (137.2 cm)
- 6614** 66" L Overall (167.6 cm)

Aluminum Extra Large Blade Peels  

16" x 18" (40.6 x 45.7 cm) Blade

- 3016** 30" L Overall (76.2 cm)
- 4016** 39 ½" L Overall (100.3 cm)
- 5616** 56" L Overall (142.2 cm)
- 6816** 68" L Overall (172.7 cm)

Aluminum Round Blade Peels  

- 17080** 8" Dia. x 20" L Blade Overall (20.3 x 50.8 cm)
- 17135** 13 ½" Dia. x 35" L Blade Overall (34.3 x 88.9 cm)
- 17160** 16" Dia. x 38" L Blade Overall (40.6 x 95.3 cm)

USA



ALUMINUM PEELS CAN BE PERFORATED TO REDUCE RESISTANCE AND WEIGHT

USA



USA



USA

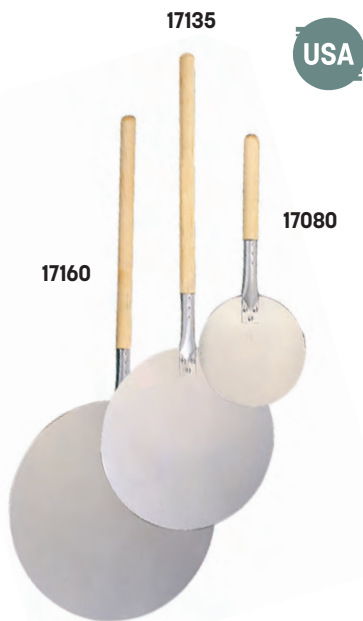

Perf P

For pricing, visit amnow.com



Deluxe Small All-Aluminum Peels

12" (30.5 cm) Square Blade

- ITP1213 27" Overall (68.6 cm)
- ITP1222 37" Overall (94 cm)
- ITP1238 52" Overall (132.1 cm)
- ITP1246 60" Overall (152.4 cm)



Deluxe Medium All-Aluminum Peels

14 1/2" (36.8 cm) Square Blade

- ITP1413 30" Overall (76.2 cm)
- ITP1422 39" Overall (99.1 cm)
- ITP1438 55 1/2" Overall (141 cm)
- ITP1446 63 1/2" Overall (161.3 cm)



Deluxe Large All-Aluminum Peels

17 1/2" x 18 1/2" (44.5 x 47 cm) Blade

- ITP1713 34" Overall (86.4 cm)
- ITP1722 43" Overall (109.2 cm)
- ITP1738 50 1/2" Overall (151.1 cm)
- ITP1746 68" Overall (172.7 cm)



Deluxe Extra Large All-Aluminum Peels

19 1/2" x 21" (49.5 x 53.3 cm) Blade

- ITP1913 37" Overall (94 cm)
- ITP1922 45 1/2" Overall (115.6 cm)
- ITP1938 62" Overall (157.5 cm)
- ITP1946 67 3/4" Overall (172.1 cm)

Linear Perforated All-Aluminum

Pizza Peels 

The newest addition to one of the largest assortments of peels in the industry. Safely move pizzas in and around a piping hot oven. Linear perforation helps with easier transfer. 14 1/2" (36.8 cm) Square Blade.

- LPITP1413 30" L Overall (76.2 cm)
- LPITP1422 39" L Overall (99.1 cm)
- LPITP1438 55 1/2" L Overall (141 cm)
- LPITP1446 63 1/2" L Overall (161.3 cm)

Small All-Aluminum Peel 

- 674 Blade
6 3/4" x 7 3/4", 20 1/2" L Overall
(17.1 x 19.7, 52.1 cm)

Chrome-on-Steel Peel Rack 

- WPH45153 4 5/8" W x 1 1/4" D x 3" H
(11.7 x 3.2 x 7.6 cm)

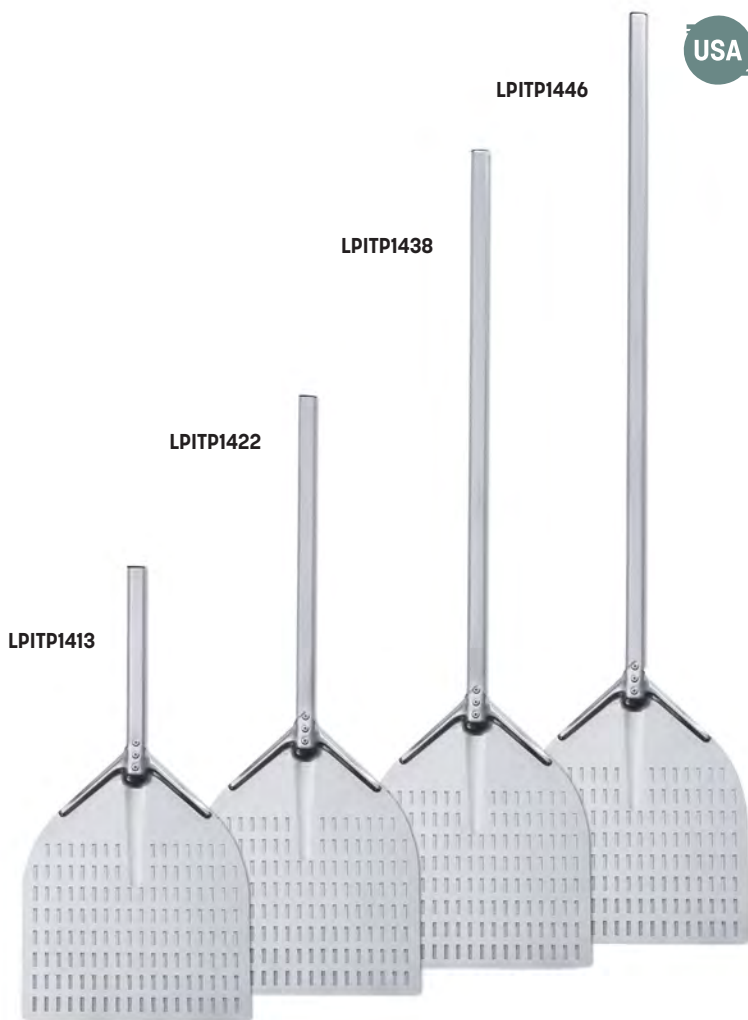

Standard Wood Peels

These peels are not only lighter in weight, but they are also lighter on the wallet. Save nearly 40% with lighter-weight versions of our best-selling sizes. Includes a hole for easy hanging.

36" L (91.4 cm) Overall

- E312** Blade 12" W x 13" L (30.5 x 33 cm)
- E314** Blade 14" W x 15" L (35.6 x 38.1 cm)
- E316** Blade 16" W x 17" L (40.6 x 43.2 cm)

42" L (106.7 cm) Overall

- E412** Blade 12" W x 13" L (30.5 x 33 cm)
- E414** Blade 14" W x 15" L (35.6 x 38.1 cm)
- E416** Blade 16" W x 17" L (40.6 x 43.2 cm)
- E418** Blade 18" W x 18" L (45.7 x 45.7 cm)
- E420** Blade 20" W x 21" L (50.8 x 53.3 cm)



LIGHTWEIGHT AFFORDABLE DESIGN

E316 **E314** **E312**



INCLUDES TAPERED EDGE
FOR EASY TRANSFER



E420 **E418** **E416** **E414** **E412**

Deluxe Wood Make-Up Peel 

32" L (81.3 cm) Overall

3218 Blade 18" W x 17 1/2" L (45.7 x 44.5 cm)



Deluxe Wood Blade 

36" L (91.4 cm) Overall

3612 Blade 12" W x 13" L (30.5 x 33 cm)

3614 Blade 14" W x 15" L (35.6 x 38.1 cm)

3616 Blade 16" W x 17" L (40.6 x 43.2 cm)

42" L (106.7 cm) Overall

4212 Blade 12" W x 13" L (30.5 x 33 cm)

4214 Blade 14" W x 15" L (35.6 x 38.1 cm)

4216 Blade 16" W x 17" L (40.6 x 43.2 cm)

4218 Blade 18" W x 18" L (45.7 x 45.7 cm)

4220 Blade 20" W x 21" L (50.8 x 53.3 cm)





Caring for Wood Peels

Want to keep your wood peel looking fresh? Always wipe it clean with a damp cloth. Never put in dishwasher, soak in water, place under a heat lamp or leave on a hot surface. If your peel warps, leave it with the warp facing up overnight and it should flatten out.

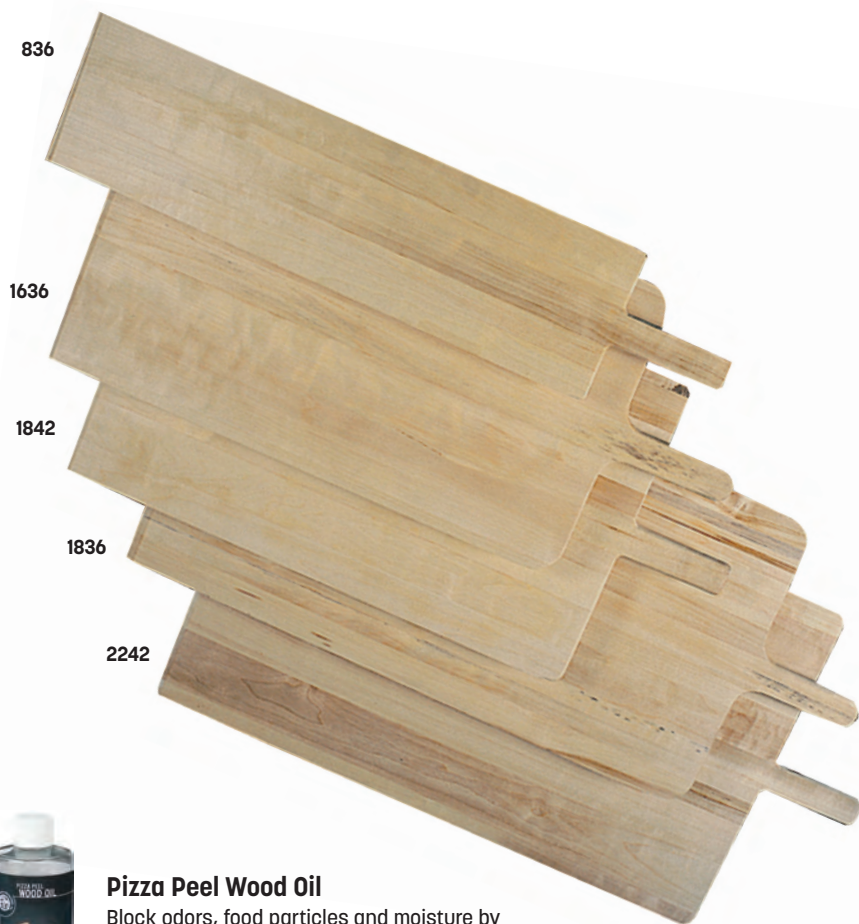

Deluxe Wood Blade Short Handle

- 814** 8" W x 9" L Blade, 14" L Overall (20.3 x 22.9 x 12.7, 35.6 cm)
- 2212** 12" W x 13" L Blade, 22" L Overall (30.5 x 33 x 22.9, 55.9 cm)
- 2414** 14" W x 15" L Blade, 24" L Overall (35.6 x 38.1 x 22.9, 60.1 cm)
- 2616** 16" W x 17" L Blade, 26" L Overall (40.6 x 43.2 x 22.9, 66 cm)

Deluxe Wood Square Blade – 39" L (99.1 cm) Overall

- 1139** Blade, 11" Sq. (27.9 cm)

Deluxe Wood Long Blade - 6 1/2" L (16.5 cm) Handle

- 36" L (91.4 cm) Overall**
- 836** Blade 8" W x 29 1/2" L (20.3 x 74.9 cm)
- 1636** Blade 16" W x 29 1/2" L (40.6 x 74.9 cm)
- 1836** Blade 18" W x 29 1/2" L (45.7 x 74.9 cm)
- 42" L (106.7 cm) Overall**
- 1842** Blade 18" W x 36" L (45.7 x 91.4 cm)
- 2242** Blade 22" W x 36" L (55.9 x 91.4 cm)



Pizza Peel Wood Oil

Block odors, food particles and moisture by seasoning your wood peels. Unlike some oils, this won't spoil. Note: Seasoning will not keep peels from wearing out.

WDOIL 8 oz. (236.6 mL)

Short Handle Ash Wood Serving Peels

These ash wood boards and peels feature rich patterns, earthy looks and unique handle designs. From charcuterie to single-serving sandwiches, there's a size for every need. See pg. 228-229 for the Ash Wood Collection boards.

AW814 8" W x 9" L Blade, 14" Overall
(20.3 x 22.8, 35.5 cm)

AW2212 12" W x 13" L Blade, 22" Overall
(30.4 x 33, 55.8 cm)

AW2414 14" W x 15" L Blade, 24" Overall
(35.5 x 38.1, 60.9 cm)

AW2616 16" W x 17" L Blade, 26" Overall
(40.6 x 43.1, 66 cm)

Short Handle Olive Wood Serving Peels

Featuring rich wood grains, our olive wood boards and peels give any tabletop an extra dimension. These pieces are exceptionally unique—no two are alike. See pg. 230-233 for the Olive Wood Collection boards.

OWP9 8" W x 9" L Blade, 14" Overall
(20.3 x 22.8, 35.5 cm)

OWP13 12" W x 13" L Blade, 22" Overall
(30.4 x 33, 55.8 cm)

OWP15 14" W x 15" L Blade, 24" Overall
(35.5 x 38.1, 60.9 cm)

OWP17 16" W x 17" L Blade, 26" Overall
(40.6 x 43.1, 66 cm)





Black Pressed Wood Serving Boards USA

Made of NSF- and USDA-listed material, these black serving boards are the perfect companion to our Mega Flatbread Screens.

- MPSB11** 11" L x 7" W x 1/4" H (27.9 x 17.8 x 0.6 cm)
- MPSB16** 16" L x 8" W x 1/4" H (40.6 x 20.3 x 0.6 cm)
- MPSB17** 17" L x 9" W x 1/4" H (43.2 x 22.9 x 0.6 cm)
- MPSB20** 20" L x 9" W x 1/4" H (50.8 x 22.9 x 0.6 cm)

Maple Pressed Wood Serving Boards USA

A beautiful maple veneer gives these boards the look and feel of wood, but they're also dishwasher-safe.

- MBSB11** 11" L x 7" W x 1/4" H (27.9 x 17.8 x 0.6 cm)
- MBSB16** 16" L x 8" W x 1/4" H (40.6 x 20.3 x 0.6 cm)
- MBSB17** 17" L x 9" W x 1/4" H (43.2 x 22.9 x 0.6 cm)
- MBSB20** 19" L x 9" W x 1/4" H (48.3 x 22.9 x 0.6 cm)



USA

MBM4 shown with GJ6 jar

Maple Pressed Wood Serving Peels USA

These presentation-worthy peels feature a beautiful maple veneer that's both food- and dishwasher-safe. Though we designed them for pizzas, they can also be used to serve appetizers, sandwiches and more.

Rectangular

MBM2 12 1/2" L x 4 3/8" W x 1/4" H, 18" L Overall
(31.8 x 11.1 x 0.6, 45.7 cm)

MBM3 12 1/2" L x 6 1/2" W x 1/4" H, 18" L Overall
(31.8 x 16.5 x 0.6, 45.7 cm)

MBM4 13" L x 8 1/8" W x 1/4" H, 18" L Overall
(33 x 20.6 x 0.6, 45.7 cm)

Round

MBM115 11 1/2" Dia. x 1/4" H, 21 1/2" L Overall
(29.2 x 0.6, 54.6 cm)

MBM155 15 1/2" Dia. x 1/4" H, 25 1/2" L Overall
(39.4 x 0.6, 64.8 cm)

MBM180 18" Dia. x 1/4" H, 28 1/2" L Overall
(45.7 x 0.6, 72.4 cm)



USA



USA



PRESSED WOOD PEELS ^{USA}

Made of NSF- and USDA-listed material. Should overcome all objections health departments have with traditional wood peels and boards.

Rectangular Pressed Wood Serving Peels

Natural

- MPG2** 12 1/2" L x 4 3/8" W x 1/4" H
18" L with Handle
(31.8 x 11.1 x 0.6, 45.7 cm)
- MPG3** 12 1/2" L x 6 1/2" W x 1/4" H
18" L with Handle
(31.8 x 16.5 x 0.6, 45.7 cm)
- MPG4** 13" L x 8 1/8" W x 1/4" H
18" L with Handle
(33 x 20.6 x 0.6, 45.7 cm)

Black

- MPB2** 12 1/2" L x 4 3/8" W x 1/4" H
18" L with Handle
(31.8 x 11.1 x 0.6, 45.7 cm)
- MPB3** 12 1/2" L x 6 1/2" W x 1/4" H
18" L with Handle
(31.8 x 16.5 x 0.6, 45.7 cm)
- MPB4** 13" L x 8 1/8" W x 1/4" H
18" L with Handle
(33 x 20.6 x 0.6, 45.7 cm)



Pressed Wood Pizza Peels

- MP1222** Blade
12" L x 14" W, 22" L with Handle
(30.5 x 35.6 x 22.9, 55.9 cm)
- MP1424** Blade
14" L x 16" W, 24" L with Handle
(35.6 x 40.6 x 22.9, 60.1 cm)
- MP1626** Blade
16" L x 17" W, 26" L with Handle
(40.6 x 45.7 x 22.9, 66 cm)



Round Pressed Wood Pizza Peels 5" L (12.7 cm) Handle

Natural

- MP813 8" Dia. (20.3 cm)
- MP914 9" Dia. (22.9 cm)
- MP1015 10" Dia. (25.4 cm)
- MP1116 11" Dia. (27.9 cm)
- MP1217 12" Dia. (30.5 cm)
- MP1318 13" Dia. (33 cm)
- MP1419 14" Dia. (35.6 cm)
- MP1520 15" Dia. (38.1 cm)
- MP1621 16" Dia. (40.6 cm)
- MP1722 17" Dia. (43.2 cm)
- MP1823 18" Dia. (45.7 cm)

Black

- MPB1015 10" Dia. (25.4 cm)
- MPB1116 11" Dia. (27.9 cm)
- MPB1217 12" Dia. (30.5 cm)
- MPB1318 13" Dia. (33 cm)
- MPB1419 14" Dia. (35.6 cm)
- MPB1520 15" Dia. (38.1 cm)
- MPB1621 16" Dia. (40.6 cm)

Make-Up Pressed Wood Pizza Peel

- MP1826 18" Sq. Blade with 8" L Handle
26" Overall
(45.7 x 20.3, 66 cm)



MP1015

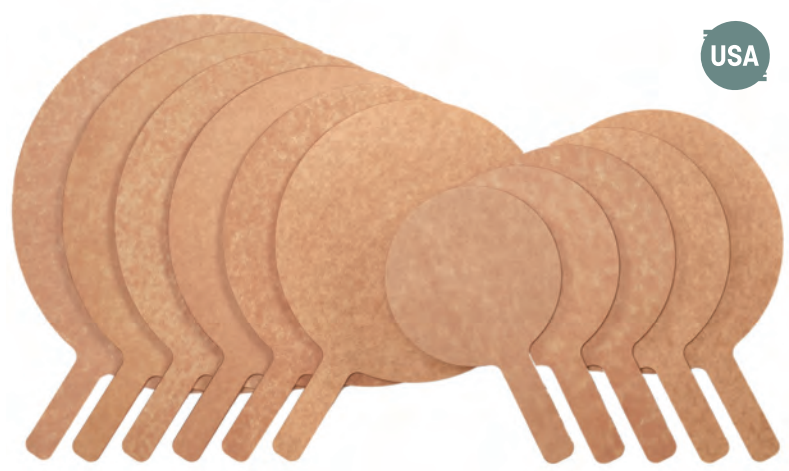

MP1823 MP1621 MP1419 MP813 MP1015 MP1217
MP1722 MP1520 MP1318 MP914 MP1116



MP1826

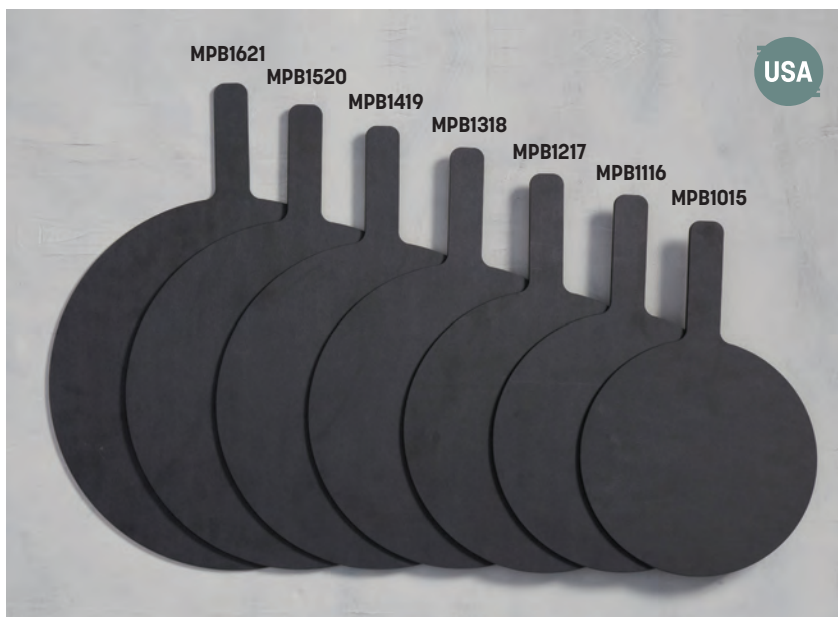

MPB1621 MPB1520 MPB1419 MPB1318 MPB1217 MPB1116 MPB1015



BLDX2005

BLDX1805



BLB1914

BLB1926

Deluxe Pizza Delivery Bags

With the golden age of food delivery upon us, we're proud to present our most advanced pizza bags to date. Featuring durable, abrasion-and mildew-resistant material and superior insulation. Plus, they're easy to clean.

- BLDX1805** 18" Sq. x 5" H
(45.7 x 12.7 cm)
Holds (2) 16" (40.6 cm) Pizza Boxes
- BLDX2005** 20" Sq. x 5" H
(50.8 x 12.7 cm)
Holds (2) 18" (45.7 cm) Pizza Boxes

Deluxe Delivery Bags with Frame

Features heavy-duty crossing straps for comfortable carrying. Perfect for carrying multiple pizzas.

With Frame

- BLB1914** 19 ½" Sq. x 14 ½" H
(49.5 x 36.8 cm)
Holds up to 6 Pizza Boxes
- BLB1926** 19" Sq. x 27" H
(48.3 x 68.6 cm)
Holds up to 10 Pizza Boxes

Bag Only

- BLBAG19** 19 ½" Sq. x 14 ½" H
(49.5 x 36.8 cm)
Holds up to 6 Pizza Boxes
- BLBAG26** 19" Sq. x 27" H
(48.3 x 68.6 cm)
Holds up to 10 Pizza Boxes



Deluxe Delivery Bags

These bags feature rust-proof iron grommets for steam ventilation. The perfect sizes for carry out containers and even grocery delivery.

BLDB1212 12 1/2" Sq. x 12" H
(31.8 x 30.5 cm)

BLDB2412 24 3/4" L x 12 1/2" W x 12" H
(62.9 x 31.8 x 30.5 cm)

Deluxe Sandwich Delivery Bag

This bag features rust-proof iron grommets for steam ventilation.

BLSB1512 15" L x 9" W x 12" H
(38.1 x 22.9 x 30.5 cm)



Deluxe Catering Delivery Bag

This satchel fits both full- and half-size food pans, making it the prime solution for delivering pastas, salads and other family-style feasts. Features easy-carry straps and an insulated interior as well as adjustable shelves and a reinforced frame.

BLDB2216 22" L x 13" W x 16" H
(55.9 x 33 x 40.6 cm)





Pizza Delivery Bags

With heavy nylon construction and reinforced stitching, these durable bags can hold two pizza boxes at a time. Contains PVC foam to keep pies oven-fresh.

- PBDX1805** 18" Sq. x 5" H
(45.7 x 12.7 cm)
Holds (2) 16" (40.6 cm) Pizza Boxes
- PBDX2005** 20" Sq. x 5" H
(50.8 x 12.7 cm)
Holds (2) 18" (45.7 cm) Pizza Boxes

Delivery Bags with Frame

The heavy nylon construction, reinforced stitching and insulating PVC foam from our Pizza Delivery Bags, supersized. Includes racks and features a two-handled strap for carrying.

With Frame

- PB1914** 19 1/2" Sq. x 14 1/2" H
(49.5 x 36.8 cm)
Holds up to 6 Pizza Boxes
- PB1926** 19" Sq. x 27" H
(48.3 x 68.6 cm)
Holds up to 10 Pizza Boxes

Bag Only

- PBBAG19** 19 1/2" Sq. x 14 1/2" H
(49.5 x 36.8 cm)
Holds up to 6 Pizza Boxes
- PBBAG26** 19" Sq. x 27" H
(48.3 x 68.6 cm)
Holds up to 10 Pizza Boxes



Sandwich Delivery Bag

Nine tiny holes let this bag breathe, making it ideal for sandwich deliveries or picnics.

- PBSB1512** 15" L x 9" W x 12" H
(38.1 x 22.9 x 30.5 cm)



Stirring Paddles

Stainless Steel Paddles

These seamless stainless steel paddles feature a 4 3/4" x 9 3/4" (12.1 x 24.8 cm) blade and 1" (2.54 cm) wide tubular handle.

- 2124** 24" L (61 cm)
- 2130** 30" L (76.2 cm)
(not shown)
- 2136** 36" L (91.4 cm)
(not shown)
- 2142** 42" L (106.7 cm)
(not shown)
- 2148** 48" L (121.9 cm)
(not shown)
- 2154** 54" L (137.2 cm)
(not shown)

Hard Wood Stirring Paddles

Smooth-sanded hardwood with a rectangular tapered blade. Blade measures 4" wide x 7/8" thick (10.2 x 2.2 cm). Handle measures 1 1/4" (3.2 cm) wide.

- 240** 24" L (61 cm)
- 300** 30" L (76.2 cm)
(not shown)
- 360** 36" L (91.4 cm)
(not shown)
- 420** 42" L (106.7 cm)
(not shown)
- 480** 48" L (121.9 cm)
(not shown)



Pizza Oven Brush with Brass Bristles and Steel Scraper

Heavily filled (65 tufts) stiff brass wire on one side and a rust-proof steel scraper on the other. Screw-on handle with extra-strong die cast aluminum threaded tip for easy attachment to 10" x 1 3/4" (25.4 x 4.5 cm) hardwood block.

- 1597** Complete Brush and 40" Handle (101.6 cm)
- 1698** Complete Brush and 60" Handle (152.4 cm)
- 1597H** Replacement Brush Only
- 159740** Handle Only 40" (101.6 cm)
- 159760** Handle Only 60" (152.4 cm)

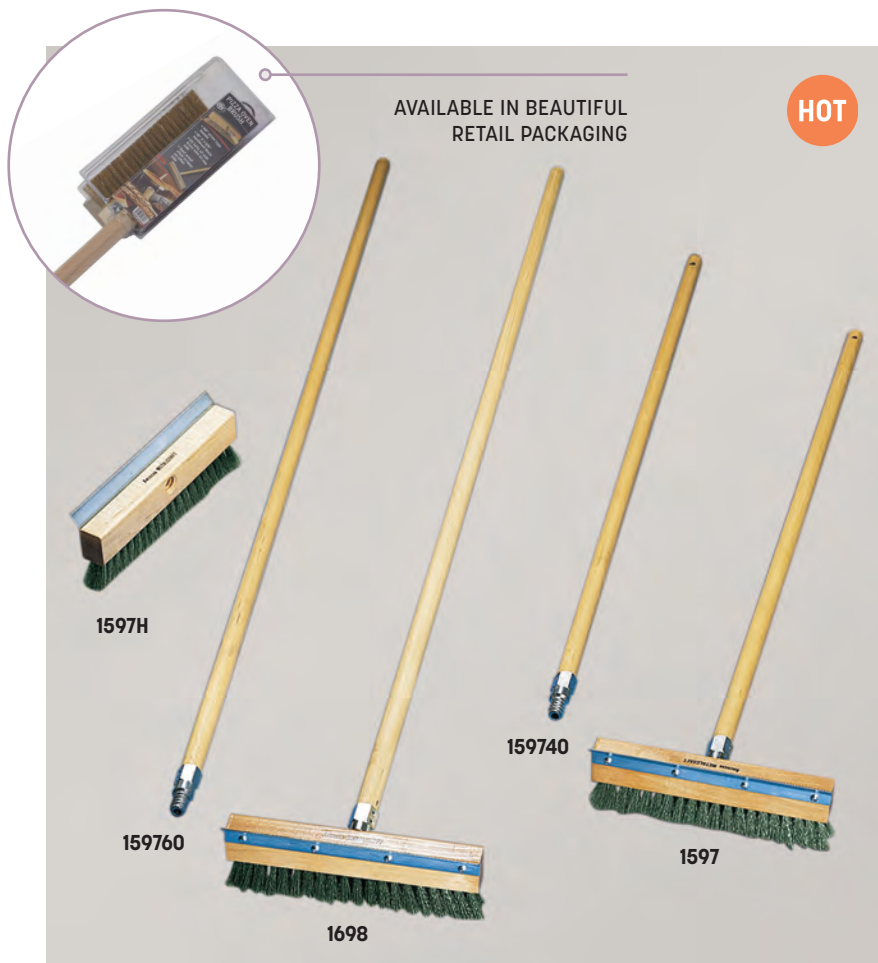



CARE AND USE

Melamine Dinnerware, Bowls and Platters

This nearly indestructible line of melamine is long-lasting when cared for properly. It is not recommended for microwave use and should be washed only in a high-temperature dishwasher. Not for use with a heat lamp or in the oven. Regarding serving suggestions, we do not recommend any citric, acidic or strong-colored food products that would have direct contact with melamine. These products can cause staining over time. PET liners that can protect melamine from staining are available for some items.



Wrought Iron Griddles

Prior to using your American Metalcraft Griddle for the first time, hand-wash with a mild detergent and warm water. Then dry thoroughly with a soft cloth. Do not put wrought iron griddles in dishwashers or expose them to abrasive sponges, caustic cleaners or acidic detergents.

Wood Peels and Serving Boards

Wood pizza peels and serving boards should never be soaked in water, even for a few minutes. To clean, simply wipe down with a damp cloth and allow to air-dry. They can be seasoned or sealed with oil. To seal, wipe any food-safe oil such as mineral oil on the surface of the peel. We recommend our Wood Oil sold on pg. 428. If sealed properly, the peel is less likely to pick up unwanted odors, food particles and moisture. If a peel warps, leave overnight with the warp facing up and it should flatten out. Avoid leaving peels on hot surfaces. This increases the chance of warping.



Carbon and Black Steel Pans

Seasoning is recommended. To season, wipe interior of pan with flavorless cooking oil and heat empty pan. When surface becomes hot, remove from heat and allow pan to cool. Repeat this process twice. Color of pan will change to a darker finish. This indicates that pan has gained a natural non-stick protection.

To clean, hand-wash in hot water with mild detergent. Dry with paper towel or place in warm oven for a few minutes. Store in dry place. Do not put in dishwasher or expose to abrasive sponges or acidic detergents. Not suitable for microwave.

CAUTION: Flat iron handle is not heat-resistant

Galvanized Pails and Tubs

To clean, hand-wash in warm water with mild detergent and dry quickly. Do not put in dishwasher or expose to abrasive sponges, bristles, caustic cleaners or acidic detergents. Do not refrigerate, soak in water or use with acidic foods.

Hammered Copper

As beautiful as these lines are, they require special attention when cleaning. Please hand-wash only with a soft cloth. Do not scour with steel wool or abrasive cleaners. Copper polish may be required to maintain the beauty of the surface.



Securit Signs

To erase Securit Original Chalk Marker messages on Table Boards, Mini Chalkboards, Wall Boards, Sandwich Boards and other Securit signage, wipe with a soapy cloth followed by a clean cloth.



Cast Iron

Before First Use

Hand-wash and dry immediately. Rub with a thin, light coat of vegetable oil to restore sheen.

After First Use

Wash with hot water (and mild soap if necessary). Dry immediately and rub with a light coat of vegetable oil. To remove excess residue, use boiling water and a plastic scrub bun or brush. Dishwashing, acidic detergents and scouring pads/bristles are not recommended. Re-season the pan when necessary to prevent food from sticking.

Daily Care Notes

Never put cold water in a hot cast iron pan; this can cause the pan to crack or warp. Store in a cool and dry place. Gas flames should not extend up the sides of cast iron cookware. When deep frying, fill cast iron cookware only to 1/3 of capacity.



PIZZA PANS AND TRAYS

Aluminum Pans and Trays

Aluminum is a soft metal that is attacked by detergents with a high alkaline or acidic nature. Use detergents made specifically for aluminum. Through repeated use, aluminum will soften and, if scoured, will thin. Hand-wash only using mild detergent made specifically for aluminum.

Tin Plate Pans

Tin plate should be seasoned before use and may need periodic re-seasoning. Tin plate will darken with use. Tin plate will also rust if refrigerated, soaked in water or left unseasoned in damp environments. Never soak in water. Wipe dry immediately after hand-washing.

To Season Tin Plate Pans

Wash in warm, soapy water and quickly dry. Brush oil on inside and outside surfaces of the pan and bake to a golden or dark brown. When seasoning, bake at regular times and temperatures. Some pans may need a second or third coating before being fully seasoned.



Hard Coat Pans

These pans are made from heavy-weight aluminum. Hard coat anodizing is a synergistic electro-chemical process that converts the surface of aluminum into aluminum oxide. The aluminum oxide is a dark color. The finish is hard and will not flake off. However, the aluminum underneath is soft and, through repeated use, the pan will soften. If scoured, the pan will thin. Hard coat pans are not non-stick and must be seasoned. Hand-wash only using mild detergent made specifically for aluminum.

To Season Hard Coat Pans

Wash and dry pans thoroughly. Wipe oil on the inside and outside surfaces of the pan and allow it to soak in for 30 minutes. Then, bake at regular cooking times and temperatures. Do not overbake and do not wash off excess oil. Just wipe clean. The oil residue and any additional oil added before baking makes the pan stick-resistant. Do not put these pans in dishwashers or expose them to caustic cleaning solutions. Hand-wash with detergents made specifically for aluminum.





Pizza Stones

This "all-natural" stone is freezer-, microwave- and oven-safe. It is not dishwasher-safe and requires hand-washing. It requires no seasoning or conditioning. Simply rinse in warm water before first use and allow the stone to dry thoroughly. Most recipes suggest preheating stone 15 to 20 minutes for even cooking and to reduce baking time. To prevent cracking, avoid moving directly between extreme temperatures, such as from the oven to cold water. Do not place stone over an open flame or in a broiler. Do not cut directly on stone. Before cleaning, allow to cool completely. Then remove baked-on foods and rinse in warm water. To avoid soapy aftertaste, do not use soap or detergent. Do not soak the stone or clean in a dishwasher. The pizza stone will darken gradually and retain some staining with use. These are a part of the stone's natural seasoning and will not harm it or affect the taste of the food. Handle the stone with care to prevent chipping or breaking.



TERMS AND CONDITIONS (2022 Catalog Effective 1/1/22)

COUNTRY OF ORIGIN  indicate products made in the United States of America.  indicates products made in a North American Free Trade Association member country.

LITERATURE Possession of our literature does not constitute an offer to sell.

PRINTING We are not responsible for printing errors.

© American Metalcraft, Inc. 2022. All Rights Reserved



3SSS.....	255, 414	1698.....	437	4016.....	423	18712.....	386
4SSS.....	255, 414	1836.....	428	4100.....	280	18713.....	386
10SD.....	367	1842.....	428	4150.....	280	18714.....	386
19SET.....	147	2109.....	423	4200.....	280	18715.....	386
106.....	342	2124.....	437	4212.....	427	18716.....	386
130SO.....	365	2130.....	437	4214.....	427	18717.....	386
131PE.....	365	2136.....	437	4216.....	427	18718.....	386
132SL.....	365	2142.....	437	4218.....	427	18719.....	386
240.....	437	2148.....	437	4220.....	427	18720.....	386
300.....	437	2154.....	437	4250.....	280	18724.....	386
360.....	437	2212.....	428	4300.....	280	18728.....	386
363.....	374	2242.....	428	4406.....	130, 409	18731.....	386
420.....	437	2414.....	428	4406T.....	130, 409	18744.....	386
425.....	280	2512.....	423	4407.....	130, 409	18907.....	399
450.....	280	2600.....	279	4407T.....	130, 409	18907P.....	388
475.....	67, 379	2601H.....	279	4909.....	423	18907PHC.....	388
480.....	437	2616.....	428	5000.....	148	18907SP.....	388
510K.....	342	2814.....	423	5212.....	423	18907SPHC.....	388
510P.....	342	3016.....	423	5414.....	423	18908.....	399
511K.....	342	3209.....	423	5616.....	423	18908P.....	388
511P.....	342	3218.....	427	6109.....	423	18908PHC.....	388
512K.....	342	3300.....	133, 412	6412.....	423	18908SP.....	388
524.....	374	3306.....	131, 410	6614.....	423	18908SPHC.....	388
524ST.....	360	3306T.....	134, 410	6816.....	423	18909.....	399
674.....	425	3307.....	131, 410	7006.....	399	18909P.....	388
699.....	374	3307T.....	134, 410	7007.....	399, 404	18909PHC.....	388
699ST.....	360	3308.....	131, 410	7007E.....	404	18909SP.....	388
744.....	379	3309.....	131, 410	7008.....	399, 404	18909SPHC.....	388
801.....	379	3312.....	133, 412	7008E.....	404	18910.....	399
814.....	428	3312T.....	134, 410	7009.....	399	18910P.....	388
836.....	428	3316.....	133, 412	7010.....	399	18910PHC.....	388
897.....	379	3316T.....	134, 410	7011.....	399	18910SP.....	388
913.....	374	3317.....	133, 412	7012.....	399	18910SPHC.....	388
913ST.....	360	3317T.....	134, 410	7013.....	399	18911.....	399
918.....	379	3318.....	133, 412	7014.....	399	18911P.....	388
918SS.....	67	3318T.....	134, 410	7015.....	399	18911PHC.....	388
989.....	379	3319.....	133, 412	7016.....	399	18911SP.....	388
1004.....	374	3319T.....	134, 410	7017.....	399	18911SPHC.....	388
1139.....	428	3500.....	148	7018.....	399	18912.....	399
1147.....	375	3512.....	423	9000.....	148	18912P.....	388
1187.....	379	3612.....	427	9525.....	408	18912PHC.....	388
1187SS.....	67	3614.....	427	13001.....	377	18912SP.....	388
1188.....	67, 379	3616.....	427	13005.....	377	18912SPHC.....	388
1190.....	67, 379	3714.....	423	17080.....	423	18913.....	399
1200.....	67, 379	3801.....	378	17135.....	423	18913P.....	388
1300.....	67, 379	3806.....	378	17160.....	423	18913PHC.....	388
1300SS.....	67	3807.....	378	18040.....	386	18913SP.....	388
1347.....	375	3808.....	378	18706.....	386	18913SPHC.....	388
1423.....	374	3809.....	378	18707.....	386	18914.....	399
1597.....	437	3810.....	378	18708.....	386	18914P.....	388
1597H.....	437	3812.....	378	18709.....	386	18914PHC.....	388
1600.....	379	3813.....	378	18710.....	386	18914SP.....	388
1636.....	428	3814.....	378	18711.....	386	18914SPHC.....	388

18915.....	399	159760.....	437	A90092.....	394	ADAGIORT26.....	160
18915P.....	388	190039.....	414	A90101.5.....	394	ADEP6.....	393
18915PHC.....	388	1900312.....	414	A90102.....	394	ADEP7.....	393
18915SP.....	388	A0150.....	148	A90111.5.....	394	ADEP8.....	393
18915SPHC.....	388	A2006.....	392	A90112.....	394	ADEP9.....	393
18916.....	399	A2007.....	392	A90121.5.....	394	ADEP10.....	393
18916P.....	388	A2008.....	392	A90122.....	394	ADEP11.....	393
18916PHC.....	388	A2009.....	392	A90131.5.....	394	ADEP12.....	393
18916SP.....	388	A2010.....	392	A90132.....	394	ADEP13.....	393
18916SPHC.....	388	A2011.....	392	A90141.5.....	394	ADEP14.....	393
18917.....	399	A2012.....	392	A90142.....	394	ADEP15.....	393
18917P.....	388	A2013.....	392	A90151.5.....	394	ADEP16.....	393
18917PHC.....	388	A2014.....	392	A90152.....	394	ADEP17.....	393
18917SP.....	388	A2015.....	392	A90161.5.....	394	ADEP18.....	393
18917SPHC.....	388	A2016.....	392	A90162.....	394	ADSEAB12.....	250
18918.....	399	A2017.....	392	A90671.5.....	394	ADSEAB14.....	250
18918P.....	388	A2018.....	392	A90672.....	394	ADSEAC12.....	250
18918PHC.....	388	A4004.....	396	AB6.....	247	ADSEAC14.....	250
18918SP.....	388	A4006.....	396	AB8.....	247	ADSEAG12.....	250
18918SPHC.....	388	A4007.....	396	AB12.....	247	ADSEAG14.....	250
18919.....	399	A4008.....	396	AB13.....	247	ADSEAS12.....	250
18919P.....	388	A4009.....	396	AB14.....	247	ADSEAS14.....	250
18919PHC.....	388	A4010.....	396	AB131.....	161	AFAUC1.....	157, 158, 173
18919SP.....	388	A4011.....	396	AB211.....	161	AFP958.....	377
18919SPHC.....	388	A4012.....	396	ABHB46.....	69	AHM485.....	374
18920.....	399	A4013.....	396	ABHB69.....	69	ALLEGCU1.....	173
18920P.....	388	A4014.....	396	ABHC46.....	69	ALLEGCU2.....	173
18920PHC.....	388	A4015.....	396	ABHC69.....	69	ALLEGPBWL15.....	353
18920SP.....	388	A4016.....	396	ABHG46.....	69	ALMH4.....	283
18920SPHC.....	388	A9005.....	394	ABHG69.....	69	ALMS5.....	283
19001.....	147	A9006.....	394	ABHS46.....	69	AO080.....	148
19004.....	147	A80012.....	378	ABHS69.....	69	AO120.....	148
19006.....	371, 418	A80061.5.....	397	AC555.....	268	AO200.....	148
19007.....	371	A80062.....	397	AC579.....	269	AOR18.....	381
19008.....	370	A80071.5.....	397	AC777.....	268	AOR24.....	381
19009.....	421	A80072.....	397	ACB118.....	283	AOR36.....	381
19024.....	422	A80081.5.....	397	ACC.....	320	AOR48.....	381
19029.....	422	A80082.....	397	ACCH.....	320	APC2.....	419
19030.....	422	A80091.5.....	397	ACF125.....	283	APCU.....	151
19033.....	422	A80092.....	397	ACHI.....	283	AR060.....	148
19075.....	371	A80101.5.....	397	ACJ.....	336	AR080.....	148
19104.....	422	A80102.....	397	ACJ1.....	336	AR100.....	148
19107.....	422	A80112.....	397	ACJ2.....	336	ARB3.....	259
28710.....	387	A80121.5.....	397	ACJ4.....	336	AS20.....	254
28711.....	387	A80122.....	397	ACJ12.....	336	ASC5.....	368
28712.....	387	A80132.....	397	ACJA.....	336	ASC12.....	368
28713.....	387	A80142.....	397	ACM.....	320	ASC24.....	368
28714.....	387	A80162.....	397	ACMH.....	320	ASC38.....	368
28715.....	387	A90071.5.....	394	ACS.....	334	ASC58.....	368
28716.....	387	A90072.....	394	ACSH.....	334	ASC84.....	368
28717.....	387	A90081.5.....	394	ACT.....	320	ASEAB12.....	250
28718.....	387	A90082.....	394	ACTH.....	320	ASEAB14.....	250
159740.....	437	A90091.5.....	394	ADAGIORD18.....	160	ASEAC12.....	250

ASEAC14.....	250	AWMSQ94.....	198	BAMCH4.....	287	BDS3.....	289
ASEAG12.....	250	AWMSQ117.....	198	BAMCHI25.....	287	BDS4.....	289
ASEAG14.....	250	AWR10.....	267	BAMRD2.....	270	BEE300.....	132, 411
ASEAS12.....	250	AWRRP.....	267	BAMRN1.....	270	BEE312.....	132, 411
ASEAS14.....	250	AWRS.....	267	BAMRSET.....	270	BEE316.....	132, 411
ASPB.....	69, 109	AWRSP.....	267	BAMSL52.....	227	BEE317.....	132, 411
ASPC.....	69, 109	B10.....	227	BAMSL82.....	227	BEE318.....	132, 411
ASPG.....	69, 109	B10G.....	39	BAMSL92.....	227	BEE319.....	132, 411
ASPS.....	69, 109	B10W.....	39	BAMSL112.....	227	BEE600.....	132, 411
ATCU.....	151	B11G.....	38	BAR6.....	356	BEE606.....	132, 411
ATHB9.....	275, 351	B11W.....	38	BARB5.....	112, 356	BEE607.....	132, 411
ATHB10.....	275, 351	B12.....	227	BARB7.....	112, 356	BEV820.....	277
ATHB14.....	275, 351	B12G.....	39	BARC5.....	112	BEVI220.....	277
ATHB16.....	275, 351	B12W.....	39	BARC7.....	112, 356	BEVB556.....	277
ATHC9.....	275, 351	B14.....	227	BARS5.....	112	BEVB6612.....	277
ATHC10.....	275, 351	B14G.....	38	BARS7.....	356	BEVC655.....	277
ATHC14.....	275, 351	B14W.....	38	BAS1.....	91	BEVC1266.....	277
ATHC16.....	275, 351	B16.....	227	BASQ620.....	382	BEVDG6.....	276
ATHG9.....	275, 351	B31.....	120	BASQ820.....	382	BEVDG20.....	276
ATHG10.....	275, 351	B34.....	120	BASQ1020.....	382	BEVDG126.....	276
ATHG14.....	275, 351	B102W.....	39	BB2.....	329	BEVDG129.....	276
ATHG16.....	275, 351	B104W.....	39	BB3.....	329	BEVG6.....	276
ATHS9.....	275, 351	B112W.....	38	BB4.....	298	BEVG20.....	276
ATHS10.....	275, 351	B114W.....	38	BB8.....	298	BEVG126.....	276
ATHS14.....	275, 351	B122W.....	39	BB12.....	298	BEVG129.....	276
ATHS16.....	275, 351	B124W.....	39	BB15.....	298	BG159.....	189
AW814.....	229, 429	B142W.....	38	BB812.....	237	BG189.....	189
AW2212.....	229, 429	B144W.....	38	BB816.....	237	BG1911.....	189
AW2414.....	229, 429	BA640A.....	382	BB6105.....	343	BG2113.....	189
AW2616.....	229, 429	BA640S.....	382	BB1WH.....	37	BH31.....	120
AWB7.....	229	BA740A.....	382	BB5WH.....	37	BHCHBC1.....	284
AWB10.....	229	BA740S.....	382	BBLWH.....	37	BHCHD1.....	284
AWB12.....	229	BA840A.....	382	BBLWM.....	37	BHCHL1.....	284
AWB147.....	229	BA840S.....	382	BBC2.....	329	BHCHL2.....	284
AWB179.....	229	BA940A.....	382	BBC39.....	358	BHCHR1.....	284
AWB617.....	229	BA940S.....	382	BBR12.....	298	BHCHS1.....	284
AWB621.....	229	BA1040A.....	382	BBR15.....	298	BHH19.....	316
AWB1016.....	229	BA1040S.....	382	BBRB.....	298	BHM2.....	132
AWB1021.....	229	BAKNOB.....	382	BBRC.....	329	BHMPLUGS.....	139
AWB1210.....	229	BAM14.....	226	BC1.....	284	BHR14.....	316
AWC49.....	346	BAM18.....	226	BCB.....	309	BHS109.....	334
AWM10.....	220	BAM22.....	226	BCH4.....	285	BHS117.....	334
AWM12.....	220	BAM53.....	227	BCH125.....	285	BHS124.....	334
AWM14.....	220	BAM73.....	227	BCM2.....	108	BHSP2.....	139
AWM17.....	220	BAM94.....	227	BCSS.....	309	BK74.....	342
AWM21.....	220	BAM124.....	227	BD35.....	48	BL10G.....	39
AWM25.....	220	BAM141.....	226	BD45.....	48	BL10W.....	39
AWM171.....	220	BAM148.....	226	BD55.....	48	BL11G.....	38
AWMEL19.....	198	BAM189.....	226	BD65.....	48	BL11W.....	38
AWMEL21.....	198	BAM211.....	226	BD72.....	48	BL12G.....	39
AWMEL23.....	198	BAM1812.....	226	BD87.....	48	BL12W.....	39
AWMSQ53.....	198	BAMBL4.....	287	BD93.....	48	BL14G.....	38
AWMSQ73.....	198	BAMBL125.....	287	BDS2.....	289	BL14W.....	38

BLACKBM1218.....	359	BNBC20132.....	84	BTTL9.....	345	CAP3.....	57
BLB1914.....	434	BNCB84.....	112	BTTL11.....	345	CAP6.....	57
BLB1926.....	434	BNCC48.....	112	BTTL13.....	359	CAP8.....	57
BLBAG19.....	434	BNRB46C.....	85	BUH18.....	316	CAP16.....	57
BLBAG26.....	434	BNRB64B.....	85	BUR15.....	316	CAP25.....	130, 409
BLCHBC1.....	284	BNRB68C.....	85	BUS309.....	414	CAP32.....	57
BLCHD1.....	284	BNRB86B.....	85	BUS312.....	414	CAR6.....	389
BLCHL1.....	284	BNSB3.....	111	BV8.....	57, 327	CAR6HC.....	389
BLCHL2.....	284	BNSC3.....	111	BV12.....	57, 327	CAR7.....	389
BLCHR1.....	284	BP39.....	421	BV16.....	57, 327	CAR7HC.....	389
BLCHS1.....	284	BP51.....	421	BV20.....	57, 327	CAR8.....	389
BLDB1212.....	435	BPG67.....	99	BVHF.....	176	CAR8HC.....	389
BLDB2216.....	435	BPG101.....	99	BVHF10.....	176	CAR9.....	389
BLDB2412.....	435	BPNS115.....	136	BVHL.....	176	CAR9HC.....	389
BLDX1805.....	434	BPT3.....	108	BVHML.....	176	CAR10.....	389
BLDX2005.....	434	BR15.....	259	BVHP.....	176	CAR10HC.....	389
BLH19.....	317	BR126.....	259	BVHP10.....	176	CAR11.....	389
BLHF10.....	176	BR128.....	259	BVHSP.....	176	CAR11HC.....	389
BLHML.....	176	BROWNBM1218.....	359	BVHSP10.....	176	CAR12.....	389
BLHP10.....	176	BRS2.....	269	BVHSS.....	176	CAR12HC.....	389
BLHSP.....	176	BS13P.....	342	BVHSS10.....	176	CAR13.....	389
BLHSP10.....	176	BS13T.....	342	BVHT1.....	176	CAR13HC.....	389
BLHSS.....	176	BS18.....	334	BVHT2.....	176	CAR14.....	389
BLHSS10.....	176	BS28.....	334	BVHT6.....	176	CAR14HC.....	389
BLHT1.....	176	BS31.....	120	BVJGB5.....	129	CAR15.....	389
BLHT2.....	176	BS64.....	369	BVJGG4.....	129	CAR15HC.....	389
BLHT6.....	176	BSB12.....	341	BVTB7.....	129	CAR16.....	389
BLLB81.....	83	BSD64.....	134	BVTG6.....	129	CAR16HC.....	389
BLLB94.....	83	BSFP8.....	362	BWB105.....	224	CAR17.....	389
BLM24.....	359	BSFP10.....	362	BWB109.....	224	CAR17HC.....	389
BLR14.....	317	BSFP11.....	362	BWB185.....	224	CAR18.....	389
BLSB80.....	83	BSFP12.....	362	BWB189.....	224	CAR18HC.....	389
BLSB93.....	83	BSG12.....	341	BWB750.....	91	CAR19.....	389
BLSB1512.....	435	BSH20.....	317	BWBL.....	225	CAR19HC.....	389
BLSMA100V4CO.....	296	BSKB80.....	86	BWBO.....	225	CAR20.....	389
BLSMA100V4TR.....	296	BSKB96.....	86	BWBR.....	225	CAR20HC.....	389
BLSMA100V4WH.....	296	BSKB811.....	87	BWBS.....	225	CAR21.....	389
BLSMA510WT.....	296	BSKC08.....	86	BWC9.....	95	CAR21HC.....	389
BLSMA720WT.....	297	BSKC69.....	86	BWC12.....	95	CAR29.....	389
BLSMAMIXV5WT.....	297	BSKC118.....	87	BWF3.....	224, 325	CAR95.....	389
BLUP5.....	35	BSPH2.....	108	BWF4.....	224, 325	CAR95HC.....	389
BLUP6.....	35	BSPH4.....	108	BWP84.....	100	CB4.....	298
BLUP8.....	35	BSPT5.....	108	BWPC35.....	149	CB8.....	298
BLUP11.....	35	BSR14.....	317	BWPG84.....	100	CB12.....	298
BLUP14.....	35	BSS7.....	90	BWPH84.....	100	CB15.....	298
BM16H.....	319	BSS8.....	90	BWPHG84.....	100	CB338.....	380
BM16P.....	319	BSS11.....	90	BWR34.....	149	CBC7.....	23, 25
BM23.....	359	BSS12.....	341	BZZ59C.....	82	CBC8.....	373
BMH221.....	280	BSSET.....	334	BZZ95B.....	82	CBC9.....	373
BNB5.....	84	BT12X12.....	359	CAB45.....	358	CBC10.....	23, 25, 27, 373
BNB7.....	84	BTS2.....	258	CADDYSS.....	135	CBC12.....	373
BNB9.....	84	BTS12.....	348	CADDYW.....	135	CBF8.....	373
BNBB13202.....	84	BTS16.....	348	CAP2.....	130, 409	CBF9.....	373

CBF10.....	373	CERAM12.....	417	CKNF4.....	175	CRS68.....	92
CBF12.....	373	CERAM14.....	417	CKNF5.....	175	CS8.....	343
CBL4.....	23	CERAM16.....	417	CKNF6.....	175	CS31.....	348
CBL8.....	22	CERAM18.....	417	CKNF7.....	175	CS080.....	335
CBL12.....	23, 25	CF1.....	161	CLIPIT2.....	283	CS100.....	335
CBL13.....	22	CFKIT.....	161	CLIPIT6.....	283	CS125.....	149
CBL16.....	23, 25, 27	CFP4.....	116	CM4.....	128	CS200.....	335
CBL20.....	22, 25	CH4.....	280	CM12.....	23, 25	CS301.....	344
CBL24.....	23	CH6.....	280	CM16H.....	319	CS7545.....	344
CBL32.....	23	CH8.....	280	CM16P.....	319	CSBRACKET.....	149
CBL40.....	23	CH10.....	280	CM96H.....	318	CSC4.....	23, 25, 125
CBL50.....	23	CHB32.....	348	CM192H.....	318	CSC15.....	118, 183
CBL78.....	195	CHBS.....	286	CMCC5.....	104	CSC20.....	118, 183
CBL95.....	22	CHBST112.....	357	CMCSW2.....	288	CSFP8.....	362
CBL185.....	195	CHC2.....	109	CMP425.....	288	CSFP10.....	362
CBL325.....	195	CHC4.....	109	CMP520.....	288	CSFP11.....	362
CBP16.....	22	CHG2.....	109	CMP553.....	288	CSFP12.....	362
CBR15.....	298	CHG4.....	109	CMSP.....	137	CSJ108.....	335
CBRB.....	298	CHGS.....	286	COLD8.....	168	CSJ116.....	335
CBRB12.....	298	CHS2.....	109	CP6.....	22, 25	CSJ174.....	335
CBS33.....	348	CHS4.....	109	CP7.....	22, 25	CSJCUP.....	335
CC10C.....	367	CHSP2.....	139	CP9.....	22, 25, 27	CSM2.....	94, 415
CC10F.....	367	CIFD.....	51	CP10.....	22, 25, 27	CSM3.....	94, 415
CC12C.....	367	CIFDR.....	51	CP12.....	22, 25, 27	CSM40.....	94, 415
CC12F.....	367	CIG17.....	168	CP300.....	129	CSP.....	137
CC40.....	358	CIG26.....	168	CP500.....	129	CSP2.....	139
CCB7.....	171, 347	CIG85.....	50	CPCHB.....	287	CSP4.....	185
CCPLUGS.....	138	CIP03.....	169	CPCHN.....	287	CSPR1.....	138
CCW7.....	171, 347	CIP04.....	169	CPCHR.....	287	CSPS3.....	138
CD4.....	355	CIP0V63.....	50	CPCHW.....	287	CSPT2.....	138
CD5.....	355	CIP0V856.....	50	CPL12.....	22	CSPW.....	137
CD6.....	355	CIP0V6040.....	50	CPL14.....	195	CSR26.....	156
CDB4.....	355	CIP0V9567.....	50	CPL21.....	195	CSWALL100.....	292
CDB5.....	355	CIPR3.....	169	CPM62.....	136	CT2.....	130, 409
CDB6.....	355	CIPR4.....	169	CRGSQ53.....	190	CTP6.....	391
CDCV77.....	161	CIPR42.....	50	CRGSQ73.....	190	CTP7.....	391
CDFP33.....	158	CIPR5125.....	50	CRGSQ94.....	190	CTP8.....	391
CDFP44.....	158	CIPR5500.....	50	CRGSQ117.....	190	CTP9.....	391
CDFP55.....	161	CIPR5526.....	50	CRGT19.....	190	CTP10.....	391
CDFP88.....	156, 160	CIPR6250.....	50	CRGT21.....	190	CTP11.....	391
CDWP18.....	160	CIPR7251.....	50	CRGT23.....	190	CTP12.....	391
CDWP26.....	160	CIPRT5336.....	50	CRH3.....	260	CTP13.....	391
CDWP66.....	161	CIPS61.....	50	CRL86.....	92	CTP14.....	391
CDWPM19.....	158	CIS8.....	169	CRM922.....	364	CTP15.....	391
CDWPM27.....	158	CIS10.....	169	CRMK1.....	118	CTP16.....	391
CER5.....	182	CIS12.....	169	CRMK2.....	118	CTP17.....	391
CER7.....	182	CIS14.....	169	CRMK3.....	118	CTP18.....	391
CER9.....	182	CIS41.....	50	CRMK4.....	118	CTP19.....	391
CER15.....	181	CIS51.....	50	CRMK6.....	118	CTS31.....	150
CER19.....	181	CIS61.....	50	CRMK45.....	118	CTSP3.....	137
CER21.....	181	CKNF1.....	175	CRMK275.....	118	CUP1.....	158, 161
CER23.....	181	CKNF2.....	175	CRS1.....	269	CWB5.....	347
CER25.....	181	CKNF3.....	175	CRS3.....	260	CWP7.....	368

CWP8	368	DRCKC7	252, 413	DWPH64	100	EWB8	66
CWP12	368	DRP774	404	DWPS44	101	EWB10	66
CWSP5	73	DRP884	404	DWPS64	101	EWM6	66
CWW5	347	DRPE800	404	DWS2	122	EWM16	66
D404	120	DRPE878	404	DWS5	103	EZLBL165	303
D405	120	DRPS5725	404	DWSC3	119	EZLM165	303
D406	120	DRPS5825	404	DWSC7	119	FBBR4	77
DB5	31	DS5	30	DWSC85	119	FBBS44	77
DB7	31	DS6704	369, 405	DWSEA10	248	FBC92	74
DB8	31	DS6706	369, 405	DWSEA12	248	FBS591	74
DB10	31, 33	DSC1	31, 125	DWSEA14	248	FBSQUARE	291
DB12	31	DSC3	31, 125	DWSEA16	248	FBSR43	77
DBN16	31, 33	DSC4	313	DWSEA18	248	FBSS44	77
DBN24	31	DSD6	313	DWSS5	122	FCD1	74
DBN32	31	DSD12	313	DWWC1	352	FCD2	74
DBP1826	404	DSP11	401	DWWC2	352	FCD3	74
DBW16	31	DSP15	401	DWWC4	352	FCH12	59
DD5274	406	DSP18	401	DWWC5	345	FCH35	58
DD5275	407	DSP6705	369, 405	DWWP50	103	FCH55	59
DD5701	406	DSR6	313	DXCH1	285	FCH325	58
DD5703	407	DSS6	313	DXCH2	285	FCS12	59
DD5704	407	DT2	130, 409	DXP4	141	FCS16	355
DD5705	406	DT3	157, 173	E312	426	FCS55	59
DDCH7744	406	DT4	157, 173	E314	426	FFB59	74
DDCH7755	406	DT6	130, 409	E316	426	FFC335	58
DDW5703	407	DWB6	247	E412	426	FFC337	58
DDW5705	406	DWB10	247	E414	426	FFCCH37	59
DGSP35	110	DWB12	247	E416	426	FFCCH45	59
DM10	30	DWB14	247	E418	426	FFCCS45	59
DPL12	30, 33	DWB16	247	E420	426	FFCCS337	59
DPL9	30	DWBH4	246, 349	EBB59B	82	FFCP4	62
DPN6	30	DWBH6	246	EBB95C	82	FFCP6	62
DPN7	30	DWBH10	246	EBSS312	357	FFCS45	58
DPN9	30, 33	DWBH12	246	ELEBLA	295	FFHANDLE	368
DPN10	30, 33	DWBH14	246	ELEBLLA	295	FFHM35	58
DPPR20	145	DWBH16	246	ELEBLME	295	FFHM37	58
DPPS24	145	DWBT15	353	ELEBLSM	295	FFHM45	58
DPR1	332	DWBT185	353	ELEBME	295	FFSD3	368
DPRC17	145	DWC5	103	ELEBSM	295	FFSR1	368
DPS17	145	DWC7	322	ELEMLA	295	FGRS7	166
DPS797	415	DWCC	346	ELEMME	295	FGRS10	166
DPSS10	145	DWCH7	322	ELEMMSM	295	FGS335	62
DPSS16	145	DWCP16	103	EM199	280, 408	FGS337	62
DPW6	30	DWCP48	102	EM200	280, 408	FH1	161
DPW7	30	DWCP50	103	EM400	280, 408	FLRB8	194
DPW9	30	DWHSEA10	248	EM1200	280, 408	FLRB11	194
DPW10	30	DWHSEA12	248	ER333	375	FLRB95	194
DRB18230	404	DWHSEA14	248	ER387	375	FR8	90
DRB18235	404	DWHSEA16	248	ER444	375	FR12	90
DRBC1826	404	DWHSEA18	248	ER487	375	FRU11	91
DRCKB6	252, 413	DWIB40	354	ER587	375	FRUB9	84
DRCKB7	252, 413	DWP44	101	ES474	375	FRUB12	91
DRCKC6	252, 413	DWP64	101	EWB6	66	FRUB18	85

FRUC7.....	84	GB8.....	128	GGW96.....	207	GSB2.....	96, 331
FRUC10.....	91	GB16.....	128	GHSP2.....	139	GSC2.....	96, 331
FRUC16.....	85	GB300.....	129	GHW4.....	349	GSC6.....	130, 409
FRYB433.....	76	GB500.....	129	GJ6.....	56	GSC16.....	163
FRYB443.....	76	GB1000.....	129	GJ8.....	56, 324	GSC17.....	163
FRYR375.....	76	GB1600.....	129	GJ24.....	56	GSC26.....	163
FRYS443.....	76	GBB15.....	189	GJ40.....	56	GSD6.....	130, 409
FRYT433.....	76	GBB20.....	189	GJ72.....	56	GSF2.....	96, 331
FS9.....	401	GBE2.....	330	GLA300.....	133, 412	GSOVL.....	165
FS911.....	372	GBE3.....	330	GLA312.....	133, 412	GSP35.....	110
FSLT08.....	212	GBE8.....	330	GLA316.....	133, 412	GSPC.....	135
FSLT10.....	212	GBE17.....	330	GLA317.....	133, 412	GSPH2.....	108
FSLT14.....	212	GBE34.....	330	GLA318.....	133, 412	GSPH4.....	108
FSLT18.....	212	GBE64.....	330	GLA319.....	133, 412	GSPR.....	135
FSLT21.....	212	GBG14.....	189	GLA600.....	130, 409	GSPS.....	135
FSLW08.....	210	GBG19.....	189	GLACT2.....	130, 409	GSPSR.....	135
FSLW10.....	210	GC8.....	331	GLADT2.....	130, 409	GSPT5.....	108
FSLW14.....	210	GCI2.....	331	GLADT6.....	130, 409	GSREC.....	165
FSLW18.....	210	GC34.....	96, 331	GLAST2.....	130, 409	GSS6.....	130, 409
FSLW21.....	210	GC36.....	96, 331	GLBASE.....	130, 409	GSS17.....	167
FSMEL12.....	211	GCD28.....	96, 331	GM13.....	221	GSSS20.....	164-166
FSMEL19.....	211	GCH28.....	96, 331	GM16H.....	319	GSSSI526.....	166
FSMEL21.....	211	GCM2.....	108	GM16P.....	319	GSST17.....	166
FSMEL23.....	211	GCRB2613.....	78	GM95.....	221	GSST2514.....	164, 166
FSMEL53.....	212	GCRC1362.....	78	GM147.....	221	GTP10.....	66,417
FSMEL73.....	212	GCS37.....	380	GM189.....	221	GTP12.....	66,417
FSMEL94.....	212	GCSS6132.....	78	GM210.....	221	GTP14.....	66,417
FSMEL117.....	212	GF2.....	330	GM1614.....	221	GTP16.....	417
FSR9.....	211	GF3.....	330	GM2113.....	221	GTP18.....	66, 417
FSR11.....	211	GF8.....	330	GMB3.....	57	GVHF.....	177
FSR14.....	211	GF17.....	330	GMB6.....	57	GVHF10.....	177
FSRW9.....	210	GF34.....	330	GMB8.....	57, 324	GVHL.....	177
FSRW11.....	210	GF68.....	330	GMB16.....	57, 324	GVHML.....	177
FSRW14.....	210	GFC45.....	62	GMB32.....	57	GVHP.....	177
FSWMEL53.....	210	GFC335.....	62	GOLDAGRDI8.....	160	GVHP10.....	177
FSWMEL73.....	210	GFC337.....	62	GOLDAGRT26.....	160	GVHSP.....	177
FSWMEL94.....	210	GGB74.....	207	GOVB69.....	81	GVHSP10.....	177
FSWMEL117.....	210	GGB76.....	207	GOVB811.....	81	GVHSS.....	177
FT15.....	119	GGB96.....	207	GOVS69.....	81	GVHSS10.....	177
FT25.....	119	GGRB3.....	206	GOVS811.....	81	GVHT1.....	177
FT40.....	119	GGRB5.....	206	GP2.....	62	GVHT2.....	177
FWB4.....	74	GGRB6.....	206	GP3.....	62	GVHT6.....	177
FWC68.....	93	GGRB8.....	206	GP4.....	62	GW4.....	349
FWC69.....	93	GGRW3.....	206	GP21.....	165	GZB7.....	56
FWC89.....	93	GGRW5.....	206	GPT3.....	108	GZB22.....	56
G17.....	164	GGRW6.....	206	GPTUB20.....	68, 353	HA2006.....	392
G21.....	165	GGRW8.....	206	GR2.....	135	HA2007.....	392
G23.....	165	GGSB5.....	207	GRI435.....	360	HA2008.....	392
G30.....	164	GGSB6.....	207	GS16.....	167	HA2009.....	392
G61.....	167	GGSW5.....	207	GS18.....	167	HA2010.....	392
G72.....	167	GGSW6.....	207	GS27.....	167	HA2011.....	392
G9595.....	408	GGW74.....	207	GS81.....	167	HA2012.....	392
GB3.....	128	GGW76.....	207	GS1775.....	167	HA2013.....	392

HA2014.....	392	HA80091.5.....	397	HACTP22.....	391	HC2011.....	392
HA2015.....	392	HA80092.....	397	HACTP23.....	391	HC2012.....	392
HA2016.....	392	HA80101.5.....	397	HACTP24.....	391	HC2013.....	392
HA2017.....	392	HA80102.....	397	HACTP26.....	391	HC2014.....	392
HA2018.....	392	HA80112.....	397	HACTP28.....	391	HC2015.....	392
HA4006.....	396	HA80121.5.....	397	HADEP6.....	393	HC2016.....	392
HA4007.....	396	HA80122.....	397	HADEP7.....	393	HC2017.....	392
HA4008.....	396	HA80132.....	397	HADEP8.....	393	HC2018.....	392
HA4009.....	396	HA80142.....	397	HADEP9.....	393	HC4006.....	396
HA4010.....	396	HA80162.....	397	HADEP10.....	393	HC4007.....	396
HA4011.....	396	HA80182.....	397	HADEP11.....	393	HC4008.....	396
HA4012.....	396	HA90071.5.....	395	HADEP12.....	393	HC4009.....	396
HA4013.....	396	HA90072.....	395	HADEP13.....	393	HC4010.....	396
HA4014.....	396	HA90081.5.....	395	HADEP14.....	393	HC4011.....	396
HA4015.....	396	HA90082.....	395	HADEP15.....	393	HC4012.....	396
HA4016.....	396	HA90091.5.....	395	HADEP16.....	393	HC4013.....	396
HA4017.....	396	HA90092.....	395	HADEP17.....	393	HC4014.....	396
HA4018.....	396	HA90101.5.....	395	HADEP18.....	393	HC4015.....	396
HA4019.....	396	HA90102.....	395	HADEP19.....	393	HC4016.....	396
HA4020.....	396	HA90111.5.....	395	HAMSC.....	121	HC4017.....	396
HA5006.....	398	HA90112.....	395	HAMSC3.....	121	HC4018.....	396
HA5007.....	398	HA90121.5.....	395	HAMSC4.....	121	HC4019.....	396
HA5008.....	398	HA90122.....	395	HAMSC15.....	121	HC4020.....	396
HA5009.....	398	HA90131.5.....	395	HAMSC25.....	121	HC5006.....	398
HA5010.....	398	HA90132.....	395	HATP6.....	390	HC5007.....	398
HA5011.....	398	HA90141.5.....	395	HATP7.....	390	HC5008.....	398
HA5012.....	398	HA90142.....	395	HATP8.....	390	HC5009.....	398
HA5013.....	398	HA90151.5.....	395	HATP9.....	390	HC5010.....	398
HA5014.....	398	HA90152.....	395	HATP10.....	390	HC5011.....	398
HA5015.....	398	HA90161.5.....	395	HATP11.....	390	HC5012.....	398
HA5016.....	398	HA90162.....	395	HATP12.....	390	HC5013.....	398
HA5017.....	398	HA90171.5.....	395	HATP13.....	390	HC5014.....	398
HA5018.....	398	HA90172.....	395	HATP14.....	390	HC5015.....	398
HA5106.....	398	HA90181.5.....	395	HATP15.....	390	HC5016.....	398
HA5107.....	398	HA90182.....	395	HATP16.....	390	HC5017.....	398
HA5108.....	398	HA90671.5.....	395	HATP17.....	390	HC5018.....	398
HA5109.....	398	HA90672.....	395	HATP18.....	390	HC5106.....	398
HA5110.....	398	HACTP6.....	391	HATP19.....	390	HC5107.....	398
HA5111.....	398	HACTP7.....	391	HATP20.....	390	HC5108.....	398
HA5112.....	398	HACTP8.....	391	HATP21.....	390	HC5109.....	398
HA5113.....	398	HACTP9.....	391	HATP22.....	390	HC5110.....	398
HA5114.....	398	HACTP10.....	391	HATP23.....	390	HC5111.....	398
HA5115.....	398	HACTP11.....	391	HATP24.....	390	HC5112.....	398
HA5116.....	398	HACTP12.....	391	HATP26.....	390	HC5113.....	398
HA9005.....	395	HACTP13.....	391	HATP28.....	390	HC5114.....	398
HA9006.....	395	HACTP14.....	391	HB5.....	70, 239	HC5115.....	398
HA80012.....	378	HACTP15.....	391	HB6.....	70, 239	HC5116.....	398
HA80061.5.....	397	HACTP16.....	391	HB7.....	70, 239	HC9005.....	395
HA80062.....	397	HACTP17.....	391	HC2006.....	392	HC9006.....	395
HA80071.5.....	397	HACTP18.....	391	HC2007.....	392	HC28710.....	387
HA80072.....	397	HACTP19.....	391	HC2008.....	392	HC28711.....	387
HA80081.5.....	397	HACTP20.....	391	HC2009.....	392	HC28712.....	387
HA80082.....	397	HACTP21.....	391	HC2010.....	392	HC28713.....	387

HC28714.....	387	HCCTP6.....	391	HCSQ1210.....	400	HM12SL.....	178
HC28715.....	387	HCCTP7.....	391	HCSQ1215.....	400	HM12SOL.....	178
HC28716.....	387	HCCTP8.....	391	HCSQ1220.....	400	HM14KN.....	178
HC28717.....	387	HCCTP9.....	391	HCSQ1410.....	400	HMBAR8.....	356
HC28718.....	387	HCCTP10.....	391	HCSQ1415.....	400	HMBAR9.....	112
HC80061.5.....	397	HCCTP11.....	391	HCSQ1420.....	400	HMBV1.....	107
HC80062.....	397	HCCTP12.....	391	HCSQ1610.....	400	HMCD4.....	355
HC80071.5.....	397	HCCTP13.....	391	HCSQ1615.....	400	HMCD5.....	355
HC80072.....	397	HCCTP14.....	391	HCSQ1620.....	400	HMCD6.....	355
HC80081.5.....	397	HCCTP15.....	391	HCSS12.....	401	HMCM2.....	107
HC80082.....	397	HCCTP16.....	391	HCSS14.....	401	HMDOB19149.....	353
HC80091.5.....	397	HCCTP17.....	391	HCSS16.....	401	HMDWB14.....	246
HC80092.....	397	HCCTP18.....	391	HCSS248.....	401	HMDWB19.....	246
HC80101.5.....	397	HCCTP19.....	391	HCSS1411.....	401	HMJ4.....	54
HC80102.....	397	HCCTP20.....	391	HCSS1812.....	401	HMJ5.....	54
HC80112.....	397	HCDEP6.....	393	HCSS2416.....	401	HMJ6.....	54
HC80121.5.....	397	HCDEP7.....	393	HCTF122410.....	400	HMMJ1.....	54
HC80122.....	397	HCDEP8.....	393	HCTF122415.....	400	HMMJ2.....	54
HC80132.....	397	HCDEP9.....	393	HCTF122420.....	400	HMMJ3.....	54
HC80142.....	397	HCDEP10.....	393	HCTP6.....	390	HMMJ4.....	54
HC80162.....	397	HCDEP11.....	393	HCTP7.....	390	HMMJ5.....	54
HC80182.....	397	HCDEP12.....	393	HCTP8.....	390	HMMS10.....	178
HC90071.5.....	395	HCDEP13.....	393	HCTP9.....	390	HMMS12.....	178
HC90072.....	395	HCDEP14.....	393	HCTP10.....	390	HMMS13.....	178
HC90081.5.....	395	HCDEP15.....	393	HCTP11.....	390	HMMS14.....	178
HC90082.....	395	HCDEP16.....	393	HCTP12.....	390	HMMS18.....	178
HC90091.5.....	395	HCDEP17.....	393	HCTP13.....	390	HMOST1115.....	242
HC90092.....	395	HCDEP18.....	393	HCTP14.....	390	HMOST1317.....	242
HC90101.5.....	395	HCDS108.....	401	HCTP15.....	390	HMOST1520.....	242
HC90102.....	395	HCDS1410.....	401	HCTP16.....	390	HMOV1418.....	242
HC90111.5.....	395	HCDS1712.....	401	HCTP17.....	390	HMOV1621.....	242
HC90112.....	395	HCHBC1.....	284	HCTP18.....	390	HMPB12.....	353
HC90121.5.....	395	HCHD1.....	284	HCTP19.....	390	HMPB20.....	353
HC90122.....	395	HCHL1.....	284	HCTP20.....	390	HMPLUGS.....	139
HC90131.5.....	395	HCHL2.....	284	HDD94.....	408	HMPRR3.....	266
HC90132.....	395	HCHR1.....	284	HDS95.....	408	HMPRS3.....	266
HC90141.5.....	395	HCHS1.....	284	HDUT975.....	372	HMRD08.....	242
HC90142.....	395	HCLP12.....	401	HDUT1200.....	372	HMRD12.....	242
HC90151.5.....	395	HCLP16.....	401	HDUT1600.....	372	HMRD16.....	242
HC90152.....	395	HCLP24.....	401	HDWS2.....	122	HMRRSET.....	266
HC90161.5.....	395	HCR86.....	387	HDWS5.....	122	HMRST1301.....	244
HC90162.....	395	HCR137.....	387	HGWC1.....	346	HMRST1401.....	244
HC90171.5.....	395	HCR148.....	387	HMILAD.....	178	HMRST1601.....	244
HC90172.....	395	HCR168.....	387	HM6TNG.....	178	HMRST1801.....	244
HC90181.5.....	395	HCSQ610.....	400	HM8TNG.....	178	HMRST2001.....	244
HC90182.....	395	HCSQ615.....	400	HM9SPN.....	178	HMRST2201.....	244
HC90671.5.....	395	HCSQ620.....	400	HM10SL.....	178	HMRT247.....	244
HC90672.....	395	HCSQ810.....	400	HM10SPO.....	178	HMRT712.....	243
HCAD10.....	387	HCSQ815.....	400	HM11CMF.....	178	HMRT814.....	243
HCAD12.....	387	HCSQ820.....	400	HM11FK.....	178	HMRT1019.....	243
HCAD14.....	387	HCSQ1010.....	400	HM12NOT.....	178	HMRT1322.....	243
HCAD16.....	387	HCSQ1015.....	400	HM12PAS.....	178	HMRT1611.....	244
HCAD18.....	387	HCSQ1020.....	400	HM12PIE.....	178	HMSP2.....	139

HMSP1813	241	HSC2	123	J203	336	JS6	343
HMSP2618	241	HSC3	123	J204	336	JSTRN6	173
HMSPH2	107	HSC4	123	J205	336	JSTRN8	172
HMSPH4	107	HSC8	123	J206	336	JSTRN12	172
HMSPT3	107	HTSH1	43	J208	336	JTUBE3	171
HMSPT5	107	HTSH3	43	J212	336	JTUBE4	171
HMSQ12	243	HTSH5	43	J214	336	JTUBE5	173
HMSQ14	243	HV3	322, 324	J222	336	JTUBE6	157
HMSQ16	243	I9540	408	J263	336	JTUBE8	172
HMSQ18	243	IBT65	271-273, 276, 277	J266	336	JTUBE12	172
HMSQ20	243	IBT125	276	JBASE1	171	JUICE1	173
HMSQ22	243	IBT126	271-273, 276, 277	JBASE2	171	JUICE2	173
HMSR6	352	IBT200	271-273, 276, 277	JBASE3	171	JUICE3	171
HMSR7	352	IC79	342	JBASE4	171	JUICE4	171
HMSR8	352	IC80	342	JBASE5	171	JUICE5	172
HMSRSPH2	107	ICETNG	337	JBASE6	171	JUICE12	172
HMSRSPH3	107	ISI2	255	JBASE7	171	KBB5	73
HMSSQPH2	107	ISI3	255	JBOD5	172	KBB7	73
HMST10	241	ISI4	255	JBOD12	172	KBB9	73
HMST12	241	ISI8	256	JC8	61, 324	KBC6	162
HMST20	241	IS734	342	JC11	61, 324	KBC10	162
HMTB12	323	IS900	342	JC12	61, 324	KBC12	162
HMTB14	323	ISPI8	256	JC14	61, 324	KBC20	162
HMTB16	323	ISSB4	354	JC16	61, 324	KBK5	73
HMTTC12	323	ISSB6	354	JC48	61, 324	KBK7	73
HMTTC14	323	ISSB8	354	JCOV1	173	KBK9	73
HMTTC16	323	ISW2	374	JCOV3	171	KNF2	51
HMTS12	323	ISW3	374	JCOV4	171	KNF3	51
HMTS14	323	IT400	113	JCOV6	157	KNF4	51
HMTS16	323	IT646	372	JCOV8	172	KNF6	51
HMWB	349	IT700	113	JCOV12	172	KNF7	51
HMWBSTND	349	IT878	372	JFAUC4	173	KNF8	51
HMWC75	347	IT909	372	JFAUC5	171	KSMC6	162
HMWP44	101	ITPI213	424	JFAUC8	157, 172	KSMC10	162
HMWP64	101	ITPI222	424	JG1	336	KSMC12	162
HMWP85	101	ITPI238	424	JG2	336	KSMC20	162
HMWP97	101	ITPI246	424	JG2A	336	L210	363
HPBL4	281	ITPI413	424	JG3	336	L215	363
HPBL6	281	ITPI422	424	JG4	336, 340	L220	363
HPBL8	281	ITPI438	424	JG5	336, 340	L1101	363
HPBL12	281	ITPI446	424	JG12	336	L1102	363
HPBL18	281	ITPI713	424	JG14	336	L1103	363
HPCH4	281	ITPI722	424	JG22	336	L1104	363
HPCH6	281	ITPI738	424	JG63	336	L1105	363
HPCH8	281	ITPI746	424	JGB4	340	L1106	363
HPCH12	281	ITPI913	424	JGB5	340	L1107	363
HPCH18	281	ITPI922	424	JGG4	340	L1108	363
HPP7	408	ITPI938	424	JGG5	340	L1112	363
HPP16	408	ITPI946	424	JMART15	322	L11005	363
HS2	123	ITS6	179	JREP3	173	L11015	363
HS3	123	J201	336	JREP4	171	LBO27	358
HS4	123	J202	336	JREP5	171	LDCC16	92
HS8	123	J202A	336	JREP6	157	LDCC17	92

LDCC18.....	92	LT14P.....	370	MCB500.....	105	MEL12.....	197
LDLB2613.....	82	LT14ST.....	370	MCBBOXAN.....	301	MEL19.....	197
LDLC1362.....	82	LT20.....	370	MCBBOXTR.....	301	MEL21.....	197
LFTB63.....	203	LT198.....	370	MCBPBSS.....	301	MEL22.....	195
LFTB65.....	203	LWUS6.....	252	MCBRBPBL.....	301	MEL23.....	197
LFTB67.....	203	LWUS536.....	252	MCC300.....	105	MEL40.....	191
LFTBB8.....	202	LWUS738.....	252	MCC500.....	105, 106	MEL41.....	191
LFTBB9.....	202	LWUS779.....	252, 415	MCCRBPBL.....	299	MEL42.....	197
LFTBB12.....	204	LWUS899.....	252	MCCRSBI.....	299	MEL43.....	197
LFTBB16.....	204	LWUS1041.....	252	MCCRSBL.....	299	MEL44.....	197
LFTBW8.....	202	LWUS1269.....	252	MCCRSWR.....	299	MEL49.....	197
LFTBW9.....	202	LWUSR.....	415	MCCWLSBL.....	299	MEL50.....	197
LFTBW11.....	202	LX306.....	131, 410	MCDDBPBL.....	301	MEL148.....	196
LFTBW12.....	204	LX307.....	131, 410	MCDRLSCORK.....	300	MEL189.....	196
LFTBW16.....	204	M30SP.....	134, 411	MCDWLSCORK.....	300	MEL1414.....	196
LFTD8.....	203	M312T.....	134, 411	MCG300.....	105	MEL2113.....	196
LFTD11.....	203	M316T.....	134, 411	MCG500.....	105	MELBPH.....	126
LFTD12.....	203	M317T.....	134, 411	MCHB125.....	285	MELPOT2.....	53
LFTPB11.....	203	M888.....	339	MCHW125.....	285	MELPOT8.....	53
LFTPB12.....	203	M1010.....	339	MCL4.....	366	MELPOT14.....	53
LFTPB13.....	203	MACD3.....	160	MCL10.....	366	MELPOT24.....	53
LFTPW11.....	203	MACTOP.....	160	MCL12.....	366	MELR5.....	32, 193
LFTPW12.....	203	MART1.....	322	MCL13.....	366	MELR6.....	32, 193
LFTPW13.....	203	MB1.....	120	MCL14.....	366	MELR8.....	32, 193
LFTPW22.....	205	MB3.....	120	MCL75.....	366	MELR9.....	32, 193
LFTPW24.....	205	MB4.....	120	MCL125.....	366	MELR11.....	32, 193
LFTW63.....	203	MB14.....	215	MCL150.....	366	MELRC3.....	191
LFTW65.....	203	MB17.....	215	MCL175.....	366	MELSC15.....	127
LFTW67.....	203	MB21.....	215	MCL200.....	366	MELSC20.....	127
LGJ6.....	56	MB25.....	215	MCP6.....	19	MELSCB21.....	127
LGJ8.....	53, 56	MB93.....	52	MCP9.....	19	MELSCB51.....	127
LGJ24.....	53, 56	MB171.....	215	MCP11.....	19	MELSL52.....	193
LGJ40.....	53, 56	MBM2.....	234, 431	MCP12.....	19	MELSL82.....	193
LGJ72.....	56	MBM3.....	234, 431	MCR72.....	52	MELSL92.....	193
LGMB3.....	57	MBM4.....	234, 431	MCTILS.....	300	MELSL112.....	193
LGMB16.....	57	MBM115.....	234, 431	MCTRBPBL.....	299	MELSQ6.....	191
LGMB68.....	57	MBM155.....	234, 431	MCTRLSBL.....	299	MELSQ8.....	191
LK50.....	286	MBM180.....	234, 431	MCTRLSLB.....	299	MELSQ10.....	191
LMJ1622.....	55	MBR15.....	213	MCW4.....	366	MELSQ53.....	192
LMJ1785.....	55	MBR18.....	213	MCW10.....	366	MELSQ73.....	192
LN722.....	147	MBR21.....	213	MCW12.....	366	MELSQ94.....	192
LNC602.....	147	MBSB11.....	236, 430	MCW13.....	366	MELSQ117.....	192
LPITP1413.....	425	MBSB16.....	236, 430	MCW14.....	366	MELWB.....	113
LPITP1422.....	425	MBSB17.....	236, 430	MCW75.....	366	MESA19.....	158
LPITP1438.....	425	MBSB20.....	236, 430	MCW125.....	366	MESA27.....	158
LPITP1446.....	425	MC41.....	52	MCW150.....	366	MESA72C.....	159
LRGJ6.....	56	MC61.....	52	MCW175.....	366	MESA72H.....	159
LS206.....	343	MC81.....	52	MCW200.....	366	MESA91C.....	159
LSB3.....	343	MCADDY.....	134, 411	MDLR7.....	339	MESA91H.....	159
LSBO.....	343	MCB10.....	19	MDLR10.....	339	MESABUCH13.....	158
LT12.....	370	MCB12.....	19	MEL5.....	194	MESABUSH13.....	158
LT12ST.....	370	MCB36.....	19	MEL7.....	194	MESABUSS13.....	158
LT14.....	370	MCB300.....	105	MEL9.....	194	MFP41.....	52

MFP81.....	52	MNST15.....	209	MPSB16.....	236, 430	MRW1215.....	200
MFRYBSKT.....	77	MNST17.....	209	MPSB17.....	236, 430	MSB2.....	237
MG578.....	335	MNSTRI2.....	209	MPSB20.....	236, 430	MSB3.....	237
MGC20.....	329	MNSTRI4.....	209	MPSW.....	222	MSB4.....	237
MGC25.....	329	MNSTRI6.....	209	MPT12.....	370	MSC8.....	31, 125
MGD20.....	329	MP6.....	37	MRCS6.....	200	MSCR2.....	126
MGD25.....	329	MP7.....	37	MRCS7.....	200	MSCRW2.....	126
MGL20.....	329	MP9.....	37	MRCS9.....	200	MSCSB3.....	126
MGL25.....	329	MP11.....	37	MRCS10.....	200	MSCSW3.....	126
MGLA3.....	134, 411	MP813.....	433	MRCS12.....	200	MSJ3.....	53
MGLCS.....	134, 411	MP914.....	433	MRCS13.....	200	MSJ4.....	53
MGR3.....	358	MP1015.....	433	MRCW6.....	200	MSJ5.....	53
MGRSP3.....	358	MP1116.....	433	MRCW7.....	200	MSP4.....	131
MGS30.....	329	MP1217.....	433	MRCW9.....	200	MSQ3.....	193
MH220.....	280	MP1222.....	432	MRCW10.....	200	MSQBSKT.....	77
MH243.....	280	MP1318.....	433	MRCW12.....	200	MSR10.....	217
MH252.....	280	MP1419.....	433	MRCW13.....	200	MSR12.....	217
MHSB7.....	282	MP1424.....	432	MRD3.....	193	MSR14.....	217
MHSC6.....	282	MP1520.....	433	MRECBSKT.....	78	MSR17.....	217
MICH5.....	63	MP1621.....	433	MRF150BL.....	127	MSR21.....	217
MICH10.....	63	MP1626.....	432	MRF150W.....	127	MSR25.....	217
MICH15.....	63, 324	MP1722.....	433	MRF250BL.....	87, 127	MSR171.....	217
MICH25.....	63	MP1823.....	433	MRF250W.....	87, 127	MSSF75.....	367
MJ16.....	55	MP1826.....	433	MRF350BL.....	127	MSSR74.....	367
MJ17.....	55, 324	MPB2.....	235, 432	MRF350W.....	127	MSSS73.....	367
MJ22.....	55	MPB3.....	235, 432	MRF450BL.....	127	MSTNG5.....	337
MJ85.....	55, 324	MPB4.....	235, 432	MRF450W.....	127	MT6.....	201
MJP3.....	55, 145	MPB1015.....	433	MRP53.....	47	MT8.....	201
MLRP9.....	192	MPB1116.....	433	MRPS45.....	47	MT10.....	201
MLRP13.....	192	MPB1217.....	433	MRPS55.....	47	MTB14.....	208
MLRP17.....	192	MPB1318.....	433	MRS150BL.....	127	MTB20.....	208
MLRP19.....	192	MPB1419.....	433	MRS150W.....	127	MTB156.....	163
MLRS9.....	194	MPB1520.....	433	MRS200BL.....	87, 127	MTB159.....	163
MLRS12.....	194	MPB1621.....	433	MRS200W.....	87, 127	MTB1512.....	163
MLRS16.....	194	MPCUT4.....	421	MRS300BL.....	127	MTP10.....	196, 417
MLRS21.....	194	MPCUT6.....	421	MRS300W.....	127	MTP12.....	196, 417
MM100.....	335	MPG2.....	235, 432	MRS400BL.....	127	MTP14.....	196, 417
MMB3.....	124	MPG3.....	235, 432	MRS400W.....	127	MTP16.....	196, 417
MMB6.....	124	MPG4.....	235, 432	MRS600BL.....	127	MTP18.....	196, 417
MMB9.....	124	MPL4.....	45	MRS600W.....	127	MTS20.....	329
MMBH3.....	124	MPL8.....	45	MRS615.....	200	MTS26.....	329
MMBH7.....	124	MPL14.....	45	MRS815.....	200	MTS32.....	329
MMJS.....	131, 325	MPL24.....	45	MRS1215.....	200	MTSH1.....	43
MMOB1.....	124	MPLA.....	222	MRSS6.....	199	MTSH3.....	43
MMOB2.....	124	MPLB.....	222	MRSS9.....	199	MTSH5.....	43
MMOB3.....	124	MPLW.....	222	MRSS12.....	199	MTUB7.....	95
MMOB25.....	124	MPNS.....	421	MRSS13.....	199	MTUB10.....	68
MMP6.....	124	MPS12.....	370	MRSW6.....	199	MTUB12.....	68
MMP8.....	124	MPS14.....	45	MRSW9.....	199	MTUB63.....	68
MNIBKR1.....	293	MPS22.....	45	MRSW12.....	199	MTUB69.....	68
MNIBLKRI.....	293	MPSA.....	222	MRSW13.....	199	MTUB83.....	68
MNIMKR1.....	293	MPSB.....	222	MRW615.....	200	MTUB93.....	68
MNST13.....	209	MPSB11.....	236, 430	MRW815.....	200	MTW6.....	201

MTW8.....	201	NSC40.....	281	OWM17.....	216	PC1093E.....	153
MTW10.....	201	NSC50.....	281	OWM21.....	216	PC1093R.....	153
MTW14.....	208	NSPDS6.....	364	OWM25.....	216	PC1112R.....	153
MTW20.....	208	NSPDS8.....	364	OWM171.....	216	PC1112S.....	153
MW14.....	215	NSPDS10.....	364	OWMP.....	232	PC1150S.....	153
MW17.....	215	NSPDS12.....	364	OWP9.....	230, 429	PC1175R.....	153
MW21.....	215	NSPDS16.....	364	OWP12.....	231	PC1206R.....	153
MW25.....	215	NSPDS20.....	364	OWP13.....	230, 429	PC1244R.....	153
MW171.....	215	NSPDS24.....	364	OWP14.....	231	PC1250S.....	153
MWC57.....	346	NSPDS30.....	364	OWP15.....	230, 429	PC7250.....	419
MWC59.....	346	NSPDS40.....	364	OWP17.....	230, 429	PC7400.....	419
MWMEL12.....	214	NSPDSSPRING.....	364	OWP18.....	231	PCG2.....	116
MWMEL19.....	214	O2BWB.....	349	OWP157.....	230	PCG4.....	116
MWMEL21.....	214	OBS58.....	90	OWP178.....	230	PCG9.....	367
MWMEL23.....	214	OBS69.....	90	OWPB9.....	233	PCG10.....	116
MWMSQ5.....	214	OBS913.....	90	OWPBI6.....	233	PCI10.....	355
MWMSQ7.....	214	OFFP7.....	360	OWPIT30.....	102	PCR25.....	104
MWMSQ9.....	214	OFFP11.....	360	OWPIT54.....	102	PCR55.....	104
MWMSQ11.....	214	OLB9.....	83	OWSP.....	232	PCS8.....	326
MWPC6X2.....	420	OLID.....	63, 113	PBI914.....	436	PCS16.....	326
MWR15.....	213	OLID2.....	63, 113	PBI926.....	436	PCS24.....	326
MWR18.....	213	OLID3.....	63, 113	PBB8.....	186	PCTL.....	326
MWR21.....	213	ORHC1.....	87	PBB9.....	186	PCW2.....	419
N9494.....	408	ORHO2.....	87	PBB12.....	186	PCW4.....	419
NB30.....	40	OSC9.....	83	PBB13.....	186	PCW5.....	419
NB32.....	40	OSCAR.....	63, 113	PBB135.....	186	PCWH2.....	116
NB50.....	40	OSCAR2.....	63, 113	PBBAG19.....	436	PCWH4.....	116
NB56.....	40	OSCAR3.....	63, 113	PBBAG26.....	436	PCWH10.....	116
NCB95.....	258	OVJ1.....	144	PBBL2.....	104	PFB6.....	184
NCS36.....	380	OVJ2.....	144	PBBL4.....	104	PFB8.....	184
NDSL59.....	83	OVJS.....	144	PBBO9.....	186	PFB10.....	184
NDSS95.....	83	OWB107.....	232	PBC25.....	104	PFW2736BL.....	291
NRA12.....	36	OWB116.....	230	PBC45.....	104	PHBS10.....	369
NRS12.....	36	OWB117.....	230	PBDX1805.....	436	PHBS14.....	369
NRV12.....	36	OWB118.....	230	PBDX2005.....	436	PHBS16.....	369
NSB1.....	282	OWB129.....	232	PBL7.....	104	PIZG3.....	419
NSB4.....	282	OWB149.....	230	PBSB1512.....	436	PIZR2.....	419
NSB6.....	282	OWB208.....	231	PBSL1.....	197, 226	PIZW1.....	419
NSB8.....	282	OWB1810.....	231	PBSL2.....	197, 226	PKR20.....	420
NSB10.....	281	OWB2213.....	231	PBSL3.....	83, 84, 197, 226	PL147.....	418
NSB12.....	282	OWBB1.....	233	PBSL53.....	192, 223, 227	PLA710.....	49
NSB20.....	281	OWBB2.....	233	PBSL73.....	192, 223, 227	PLA810.....	49
NSB30.....	281	OWBB8.....	233	PBSL94.....	192, 223, 227	PLA912.....	49
NSB40.....	281	OWBB9.....	233	PBSL124.....	192, 223, 227	PLP147.....	418
NSB50.....	281	OWBB15.....	233	PBSLREC.....	223	PMA8.....	142
NSC1.....	282	OWBG8.....	233	PC0825S.....	153	PMA12.....	142
NSC4.....	282	OWBG9.....	233	PC0875S.....	153	PMBA8.....	142
NSC6.....	282	OWBG15.....	233	PC0900S.....	153	PMBA12.....	142
NSC8.....	282	OWBS.....	349	PC0950R.....	153	PMBL8.....	142
NSC10.....	281	OWLP.....	232	PC0988S.....	153	PMBL12.....	142
NSC12.....	282	OWM10.....	216	PC1025S.....	153	PMC2.....	326
NSC20.....	281	OWM12.....	216	PC1062E.....	153	PMC3.....	326
NSC30.....	281	OWM14.....	216	PC1068R.....	153	PMC15.....	326

PMG6.....	144	PR18.....	405	PTS9.....	179	RG6.....	261
PMJ16.....	57, 327	PR78921.....	357	PTUB87.....	68	RG7.....	261
PMJ26.....	57, 327	PR78922.....	357	PVCLA.....	295	RG5341.....	360
PMJL.....	57, 327	PR78923.....	357	PVCME.....	295	RGJ4.....	56
PMKNOB.....	142, 143	PR78924.....	357	PVCSM.....	295	RGJ6.....	56
PMRI2.....	143	PR78925.....	357	PW10.....	363	RHG1.....	264
PMSA62.....	142	PR78926.....	357	PW12.....	363	RHSSIGNBLK.....	309
PMSBA62.....	142	PR78927.....	357	PW14.....	363	RHSSIGNLSPS.....	309
PMSBL62.....	142	PR78928.....	357	PW16.....	363	RM10.....	218
PMSKNOB.....	142	PRP500.....	405	PW18.....	363	RM12.....	218
PMSR62.....	143	PRS2.....	144	PWB3.....	114	RM13.....	219
PMSS8.....	142	PRS14.....	420	PWB45.....	114	RM14.....	218
PMSS12.....	142	PRS22.....	420	PWBB3.....	114	RM17.....	218
PMSS62.....	142	PRSD3.....	117	PWBB10.....	72	RM21.....	218
PMSW62.....	143	PS10.....	371, 418	PWBB12.....	72	RM25.....	218
PMW8.....	143	PS12.....	370	PWBB45.....	114	RM95.....	219
PMWI2.....	143	PS12ST.....	370	PWBC7.....	114	RM147.....	219
PNS13.....	136	PS14.....	370	PWBC8.....	114	RM189.....	219
PNS24.....	136	PS14P.....	370	PWBS4.....	114	RM210.....	219
PNTBLSM.....	303	PS125.....	402	PWC7.....	114	RM1614.....	219
POR9.....	183	PS127.....	418	PWC8.....	114	RM2113.....	219
POR17.....	183	PS196.....	371, 418	PWK19.....	420	RMB11.....	218
POR1783.....	185	PS197.....	371	PWRB10.....	72	RMB12.....	218
PORB29.....	118	PS1116.....	402	PWRB12.....	72	RMB14.....	218
PORB30.....	118	PS1416.....	402	PWS4.....	114	RMB59C.....	78
PORD39.....	118	PS1575.....	402	RAM1.....	149	RMB95B.....	78
PORS136.....	185	PS19008.....	371	RB15.....	121	ROB2613.....	82
PORS140.....	185	PS19075.....	371	RB25.....	121	ROC1362.....	82
PORS3R.....	116	PSBL.....	104	RBHB975.....	95	RP5713.....	405
PPC2.....	419	PSFSP.....	371	RBHC759.....	95	RP5715.....	405
PPC4.....	419	PSG127.....	418	RBHMSG.....	312	RP5718.....	405
PPC5.....	419	PSLT2.....	117, 138	RBHSIGNBL.....	307	RRB2.....	262
PPCHIB.....	64	PSLT17.....	117, 138	RBHSIGNS.....	307	RRG2.....	262
PPCH2N.....	64	PSP2.....	138	RBNB16.....	93	RS12.....	280
PPCH3N.....	64	PSP4.....	186	RBNB17.....	93	RS18.....	280
PPCH3R.....	64	PSP8.....	186	RBNC26.....	93	RSB1.....	268
PPCH4N.....	64, 413	PSP12.....	186	RBNC27.....	93	RSB307.....	416
PPCHARDWARE.....	419	PSPH3.....	111	RBR3.....	270	RSB312.....	416
PPCN1010.....	64	PSPH4.....	111	RBSBL.....	306	RSBPBL.....	308
PPCN1212.....	64	PSPL8.....	186	RBSIGNBL.....	307	RSC1.....	121
PPCN1616.....	64	PSPL12.....	186	RBSIGNS.....	307	RSC3.....	121
PPK17.....	420	PSS12.....	402	RBSS.....	306	RSC4.....	121
PPL4.....	65	PSS15.....	402	RBVMSG.....	312	RSCLC.....	310
PPL7.....	65	PSS77.....	415	RC5.....	355	RSCLCHB1.....	310
PPL12.....	65	PTBC.....	147	RD412.....	154	RSCLCHB2.....	310
PPRC76.....	64	PTBR.....	147	REVLJUICESQ12.....	157	RSCLG.....	310
PPRN76.....	64	PTC8.....	179	REVLOSCUI2.....	157	RSCLGOA1.....	310
PPRN1100.....	64	PTCC.....	147	REVLRD20.....	156	RSCLGOA2.....	310
PPRN1616.....	64, 413	PTCR.....	147	REVLRD20BASE.....	156	RSCLRPCHBL.....	311
PPRN2121.....	64	PTL12.....	326	REVLRT26.....	156	RSCLRPCHBR.....	311
PPRW1010.....	64	PTL14.....	326	REVLRT26BASE.....	156	RSCLRPCHBU.....	311
PPRW1212.....	64	PTL20.....	326	REVLURN12.....	157	RSCLRPCHRD.....	311
PPRW1616.....	64, 413	PTL24.....	326	RFP18RD.....	156, 160	RSCLRPGOBL.....	311

RSCLRPGOBR	311	SB325	71, 238	SCH6	94	SIGNCR11	278
RSCLRPGOBU	311	SB400	71, 238	SCH7	94	SIGND4	278
RSCLRPGORD	311	SB450	71, 238	SCH8	94	SIGNHT1	278
RSCLWHCH	311	SB575	71, 238	SCH9	59	SIGNIT2	278
RSCLWHGO	311	SBB3	65	SCHB6	94	SIGNM8	278
RSG3	264	SBB4	65	SCHB7	94	SIGNMR	278
RSH1	265	SBBL	163	SCHB8	94	SIGNNS	278
RSLWCH	310	SBBL13202	83	SCM2	106	SIGNR6	278
RSM2	268	SBBS	163	SCM3	105	SIGNS7	278
RSQB2	262	SBC5	278	SCM4	105	SIGNSD	278
RSQG2	262	SBD5	278	SCM6	105	SIGNSH	278
RSR10	253, 416	SBDB85	304	SCMB3	105	SIGNSK9	278
RSR307	416	SBDBL85	304	SCMB4	105	SIGNW5	278
RSR312	416	SBDM85	304	SCMB6	105	SISSSET	292
RSRB	253, 416	SBH3	70, 239	SCMG3	105	SKS514	373
RSRB3	253, 416	SBH5	70, 239	SCMG4	105	SKS714	373
RSRB4	253, 416	SBH7	70, 239	SCMG6	105	SL74	207
RSRB7	253, 416	SBH325	70, 239	SCRACK5	154	SL76	207
RSRTBK	308	SBH400	70, 239	SCS3	60	SL96	207
RSRTBLC8	308	SBH450	70, 239	SCSM	60	SLL1	174
RSRTBLC9	308	SBH575	70, 239	SD3511	147	SLL2	174
RSRTGY	308	SBHL	265	SDRCK	251, 414	SLL4	174
RSRTLWCH	308	SBHS	265	SDRCK4	251, 414	SLL6	174
RSRTRD	308	SBHW5	278	SDWB40	246	SLPI21	174
RSRTRVSBLC4	308	SBL	265	SDWB45	246	SLR3	206
RSRTRVSC3	308	SBL353	111	SDWB55	246	SLR5	206
RSRTRVSGYC2	308	SBN3	65	SDWC7	347	SLR6	206
RSRTRVSRDC1	308	SBN4	65	SDWP64	100	SLR8	206
RSS3	265	SBO7	338	SDWW5	347	SLS5	207
RSSB3	253, 416	SBO154	358	SEA10	248	SLS6	207
RSSB7	253, 416	SBP30	421	SEA12	248	SLWC2	346
RSSIGNBLK	309	SBR5	278	SEA14	248	SM9	338
RSSIGNLSPC	311	SBS	265	SEA16	248	SMA100WT	296
RSSIGNLSPG	311	SBS533	111	SEA18	248	SMA510V4	296
RSSIGNLSPS	309	SBSB135	304	SEA20	248	SMA510V4WT	296
RSSPH2	106	SBSBL120	304	SECSTN5	297	SMA510V8ET	296
RSTDB60	292	SBSBMNI	293	SFBB5312	83	SMA510WT	296
RTSSPH3	106	SBSM135	304	SGL106	134	SMA720V4	297
RTWVY1	181	SBSN135	304	SHIP32	47	SMA720V4WT	297
S208	343	SBSNG135	304	SHIP41	47	SMA720V8ET	297
S209	343	SBW3	65	SHSP20	46	SMA720WT	297
SAC35	283	SBW4	65	SHSP21	46	SMB3	15, 122
SAC40	283	SBW5	338	SHSP32	46	SMB4	15, 122
SAN300	133, 412	SBW7	338	SHSP40	46	SMB5	15, 122
SAN312	133, 412	SBW9	338	SHSP41	46	SMB6	15
SAN316	133, 412	SBW10	338	SHSP53	46	SMB10	15
SAN317	133, 412	SC9	59	SHT8	68	SMP4	15
SAN318	133, 412	SCB3	60	SHT9	68	SMP6	15
SAN319	133, 412	SCB480	91	SHT10	68	SMP9	15
SB1	238	SCBL	161	SHT17	68	SMP11	15
SB3	71, 238	SCBM	60	SIGNAS	278	SMS1	279
SB5	71, 238	SCF2	161	SIGNC3	278	SMSC4	333
SB7	71, 238	SCG8	367	SIGNCO	278	SMSC8	333

SMSR4.....	333	SPT14.....	174	SQVL712.....	181	SSD50.....	372
SMSR8.....	333	SQ600.....	400	SQVL914.....	181	SSD65.....	372
SN60.....	147	SQ610.....	400	SQVY1.....	117, 184	SSD80.....	372
SNB2.....	282	SQ615.....	400	SQVY2.....	117, 184	SSD105.....	372
SNC1.....	282	SQ620.....	400	SQVY3.....	117, 184	SSEA10.....	248
SNF700.....	147	SQ800.....	400	SQVY4.....	117, 184	SSEA12.....	248
SNT612.....	147	SQ810.....	400	SQVY5.....	184	SSEA14.....	248
SOCH.....	287	SQ815.....	400	SQVY8.....	184	SSEA16.....	248
SP4.....	141	SQ820.....	400	SQVY10.....	184	SSEA18.....	248
SP6.....	141	SQ1000.....	400	SQVY12.....	184	SSFC7.....	75
SP29.....	141	SQ1010.....	400	SR6063.....	377	SSHW5.....	278
SP35.....	141	SQ1015.....	400	SR6073.....	377	SSKNF8.....	51
SPI25.....	136	SQ1020.....	400	SR6083.....	377	SSKNF9.....	51
SPI26.....	136	SQ1200.....	400	SR6093.....	377	SSLB83.....	83
SPBLTP.....	305	SQ1210.....	400	SR6103.....	377	SSLB94.....	83
SPC.....	110	SQ1215.....	400	SRBNB1.....	93	SSMS9.....	49
SPC2.....	110	SQ1220.....	400	SRBNC2.....	93	SSOC97.....	83
SPC3.....	110	SQ1400.....	400	SRCH4.....	285	SSP2.....	139
SPDB11.....	141	SQ1410.....	400	SRCH125.....	285	SSP4.....	17
SPDB33.....	141	SQ1415.....	400	SRG3.....	261	SSP6.....	17
SPDG11.....	141	SQ1420.....	400	SRG4.....	261	SSP8.....	17
SPDG33.....	141	SQ1600.....	400	SRS3.....	261	SSP9.....	17
SPDX11.....	141	SQ1610.....	400	SRS4.....	261	SSP10.....	17
SPDX22.....	141	SQ1615.....	400	SS59.....	74	SSP12.....	17
SPDX33.....	141	SQ1620.....	400	SS92.....	74	SSP13.....	17
SPGTP.....	305	SQB55.....	183	SS782.....	372	SSP25.....	63
SPH.....	110	SQB88.....	183	SSB28.....	89	SSP35.....	63
SPLB6.....	135	SQFBBL.....	75	SSB75.....	376	SSP35R.....	63
SPLB7.....	135	SQFBCN.....	75	SSB96.....	89	SSP43.....	63
SPLB9.....	135	SQFBCN10.....	75	SSB150.....	376	SSP61.....	63
SPLBCAP.....	135	SQFBCN20.....	75	SSB200.....	376	SSP120.....	174
SPM4.....	141	SQFBSS.....	75	SSB300.....	376	SSPH2.....	106
SPN2.....	365	SQGB6.....	79	SSB400.....	376	SSPH4.....	106
SPN3.....	365	SQGB8.....	79	SSB500.....	376	SSPT3.....	106
SPN4.....	365	SQGB10.....	79	SSB800.....	376	SSPT5.....	106
SPN5.....	365	SQGB12.....	79	SSB1300.....	376	SSQ53.....	245
SPN6.....	365	SQGS6.....	79	SSB1600.....	376	SSQ73.....	245
SPN8.....	365	SQGS8.....	79	SSB2000.....	376	SSQ94.....	245
SPNP2.....	365	SQGS10.....	79	SSBT11.....	345	SSQ117.....	245
SPNP3.....	365	SQGS12.....	79	SSBT14.....	345	SSQH53.....	245
SPNP4.....	365	SQND7.....	182	SSBV1.....	106	SSQH73.....	245
SPNP5.....	365	SQND9.....	182	SSC5.....	278	SSQH94.....	245
SPNP6.....	365	SQND11.....	182	SSC15.....	120	SSQH117.....	245
SPNP8.....	365	SQND13.....	182	SSC17.....	369	SSR4.....	266
SPP326.....	111	SQND15.....	182	SSC18.....	369	SSR5.....	278
SPPLUGS.....	141	SQP10.....	196	SSC19.....	369	SSR8.....	266
SPR725.....	380	SQP12.....	196	SSC25.....	120	SSR12.....	266
SPRV1.....	305	SQP16.....	196	SSCC6.....	92	SSRT962.....	78
SPRV2.....	305	SQSC15.....	117, 182	SSCC7.....	92	SSS8.....	338
SPRV3.....	305	SQSC20.....	117, 182	SSCC8.....	92	SSSK.....	51
SPS11.....	174	SQSC30.....	117, 182	SSCH4.....	285	SST10.....	240
SPSLTP.....	305	SQSC40.....	117, 182	SSCH125.....	285	SST12.....	240
SPSSWM2.....	305	SQSSPH2.....	106	SSD5.....	278	SST14.....	240

SSUS1.....	251, 415	SW4.....	247, 349	TASSM.....	254	TP19.....	390
SSUS6.....	252	SW4C.....	347	TABLA5.....	293	TP20.....	390
ST2.....	130, 409	SW6TNG.....	179	TABLA6.....	293	TPREC3.....	256
ST10.....	240	SW9SPN.....	179	TABLA7.....	293	TPRS.....	340
ST12.....	240	SW9TNG.....	179	TABLA8.....	293	TR18.....	381
ST20.....	240	SW10SPO.....	179	TCWS5.....	73	TR24.....	381
STH6.....	352	SW11CMF.....	179	TF122410.....	400	TR30.....	381
STH8.....	352	SW11FK.....	179	TF122415.....	400	TR36.....	381
STH14.....	352	SWI2NOT.....	179	TF122420.....	400	TR48.....	381
STH16.....	352	SWI2PAS.....	179, 371	TG8.....	174, 337	TRPZ12.....	199
STONE12.....	403	SWI2PIE.....	179	TGC.....	337	TRPZ18.....	199
STONE13.....	403	SWI2SL.....	179	TGP.....	337	TRPZ23.....	199
STONE14.....	403	SWI2SOL.....	179	TGP8.....	174, 337	TRSD1815.....	150
STONE15.....	403	SWI4KN.....	179	TGS.....	337	TRSH12.....	381
STS2.....	260	SWB.....	349	TGS6.....	174, 336	TRSH18.....	381
STS3.....	260	SWBSTND.....	349	TGS7.....	174, 336	TRSH24.....	381
STUB10.....	68	SWC48.....	346	TGS8.....	174, 336	TRVO53.....	51
STUB12.....	68	SWCH.....	287	TGS9.....	174, 336	TRVO85.....	51
STUB20.....	68, 353	SWSC.....	346	TGS12.....	174, 336	TRVR5.....	51
STUB63.....	68	SZ56.....	338	THMB1.....	44	TRVR8.....	169
STUB69.....	68	T10SDC.....	367	THMB3.....	44	TRVR10.....	169
STUB83.....	68	T10SDF.....	367	THMB5.....	44	TRVR675.....	51
STUB87.....	68	T10SDM.....	367	THMW1.....	44	TSC7.....	131, 412
STUB93.....	68	T80061.5.....	397	THMW3.....	44	TSCB2.....	126
STUF5.....	339	T80062.....	397	THMW5.....	44	TSCB4.....	126
STWB6.....	321	T80071.5.....	397	THN61.....	147	TSCB15.....	126
STWB8.....	321	T80072.....	397	THOV19.....	245	TSF7.....	131, 412
STWB10.....	321	T80081.5.....	397	THRC21.....	245	TSFP10.....	376
STWBRSH.....	321	T80082.....	397	THRD17.....	245	TSH1.....	43
STWBSKT.....	321	T80091.5.....	397	THW8.....	44	TSH3.....	43
STWC6.....	321	T80092.....	397	TIM1.....	113	TSH5.....	43
STWC8.....	321	T80101.5.....	397	TIM2.....	113	TTDB2.....	75
STWC10.....	321	T80102.....	397	TIM3.....	113	TTMC3.....	279
STWG6.....	321	T80112.....	397	TLSP1219.....	255, 415	TTMEL3.....	256
STWG8.....	321	T80121.5.....	397	TMW9.....	198	TTREC3.....	256
STWG10.....	321	T80122.....	397	TMW13.....	198	TTRS3.....	256
STWS6.....	321	T80132.....	397	TMW16.....	198	TTRSMEL7.....	256
STWS8.....	321	T80142.....	397	TONG2.....	174	TTS2319.....	260
STWS10.....	321	T80162.....	397	TONG3.....	174	TTSB3.....	279
SVHF.....	177	TAGA6BL.....	290	TOPPNS1.....	136	TTSVG3.....	279
SVHF10.....	177	TAGA6WT.....	290	TP6.....	390	TV3.....	73
SVHL.....	177	TAGA7BL.....	290	TP7.....	390	TV4.....	73
SVHML.....	177	TAGA7WT.....	290	TP8.....	390	TV6.....	73
SVHP.....	177	TAGA8BL.....	290	TP9.....	390	TV8.....	73
SVHP10.....	177	TAGA8WT.....	290	TP10.....	390	TV9.....	73
SVHSP.....	177	TAGBOTTLE.....	291	TP11.....	390	TWBB53.....	223
SVHSP10.....	177	TAGBUBBLE5.....	289	TP12.....	390	TWBB73.....	223
SVHSS.....	177	TAGHLDBL.....	290	TP13.....	390	TWBB94.....	223
SVHSS10.....	177	TAGHLDTR.....	286	TP14.....	390	TWBB124.....	223
SVHT1.....	177	TAGRECTANGLE5.....	289	TP15.....	390	TWBREC.....	223
SVHT2.....	177	TAGSBSWT.....	293	TP16.....	390	TWOB6.....	341
SVHT6.....	177	TASLG.....	254	TP17.....	390	TWOG6.....	341
SWILAD.....	179	TASMED.....	254	TP18.....	390	TWOS6.....	341

TWSB6.....	341	WBP34.....	98	WP68.....	99	WVASS.....	177
TWSG6.....	341	WBPCAP.....	98	WP100.....	99	WVASS10.....	177
TWSS6.....	341	WBS24.....	348	WPH45153.....	425	WVAT1.....	177
UBR5.....	13	WBSM42.....	348	WPM8.....	143	WVAT2.....	177
UBR10.....	13	WBUBL60.....	303	WPM12.....	143	WVAT6.....	177
UBR16.....	13	WBUBL70.....	303	WPM18.....	143	XXRSRTCAP.....	308
UBR24.....	13	WBUM60.....	303	WPMKNOB.....	143		
UBR32.....	13	WBUM70.....	303	WPMS62.....	143		
UBR48.....	13	WBW.....	301	WPSF33.....	103		
UBS10.....	12	WBW80.....	89	WPSF67.....	103		
UBS16.....	12	WBW96.....	89	WPU71.....	49		
UBS60.....	12	WBWBL2040.....	303	WPU81.....	49		
UM12.....	13	WBWBL3040.....	303	WPU91.....	49		
UPLR10.....	13	WBWBL4060.....	303	WRPC5713.....	405		
UPLS10.....	12	WBWBL6080.....	303	WRPC5715.....	405		
UPR6.....	13	WBWR3.....	291	WRPC5718.....	405		
UPR9.....	13	WC40.....	98	WRPCHARDWARE.....	405		
UPR11.....	13	WCBA4.....	115, 271	WSB69.....	89		
UPS6.....	12	WCBA7.....	115, 271	WSB82.....	89		
UPS9.....	12	WCBL4.....	115, 273	WSBL15.....	188		
UPS11.....	12	WCBL7.....	115, 273	WSBM11.....	188		
USCR2.....	13, 125	WCC1.....	98	WSLB27.....	188		
USCS2.....	12, 125	WCFS462.....	346	WSMB17.....	188		
UT707.....	337, 372	WCMA.....	344	WSP15.....	188		
UT975.....	372	WCRP.....	344	WSPR2B.....	95		
UT1200.....	372	WCS137.....	344	WSPR3C.....	95		
UT1600.....	372	WCS867.....	344	WSRT21.....	188		
VBRI.....	144	WCS871.....	344	WTBA6.....	271		
VWB26.....	144	WCSB415.....	344	WTBA10.....	271		
WB8C.....	347	WCV4.....	115, 272	WTBA12.....	271		
WB9.....	347, 348	WCV7.....	115, 272	WTBA20.....	271		
WB32.....	97, 332	WCW69.....	89	WTBL6.....	273		
WB33.....	97, 332	WCW81.....	89	WTBL10.....	273		
WB34.....	97, 332	WFB3.....	183	WTBL12.....	273		
WB35.....	97, 332	WFB6.....	183	WTBL20.....	273		
WBB.....	301	WFB9.....	183	WTSB33.....	150		
WBB9.....	88	WFB12.....	183	WTSB40.....	150		
WBB11.....	88	WIB80.....	80	WTSM31.....	150		
WBBM.....	88	WIB100.....	80	WTSM38.....	150		
WBBR80.....	88	WIB120.....	80	WTSW32.....	150		
WBBS.....	88	WICS34.....	348	WTSW39.....	150		
WBBV90.....	88	WIFH2.....	166	WTV6.....	272		
WBC34.....	97	WIR3.....	89	WTV10.....	272		
WBC36.....	97	WIR4.....	89	WTV12.....	272		
WBC705.....	91	WISS8.....	80	WTV20.....	272		
WBCAP.....	97, 332	WISS10.....	80	WVAF.....	177		
WBCC6.....	92	WISS12.....	80	WVAF10.....	177		
WBCC7.....	92	WLD11.....	185	WVAL.....	177		
WBCC8.....	92	WLD13.....	185	WVAML.....	177		
WBCG85.....	303	WLD15.....	185	WVAP.....	177		
WBCG105.....	303	WMEL19.....	222	WVAPI0.....	177		
WBCLINER.....	84, 91	WMEL21.....	222	WVASP.....	177		
WBO3.....	358	WMEL23.....	222	WVASP10.....	177		

A

ALTERNATIVE DRINKING VESSELS.....	324
ANODIZED PANS.....	387-401
ANTIQUE COPPER COLLECTION.....	112, 320, 334, 336, 356
ASH WOOD.....	229, 429
AU GRATIN SERVICE.....	148

B

BAGS.....	64-65, 73, 434-436
BALTI DISHES.....	48
BAMBOO.....	115, 142, 224-227, 270-271 287, 298, 325
BAR BOARDS.....	343
BAR MATS.....	359
BAR SPOONS.....	341-342
BAR STRAINERS.....	343
BAR TOOLS.....	338-343
BAR TRAYS.....	275, 345, 350-351
BAR UTENSILS.....	338
BARRIER SYSTEMS.....	306-311
BASKETS.....	74-91, 223
BASTING COVERS.....	382
BEAKERS.....	330
BENTO BOXES.....	37-39
BEVERAGE BOTTLES.....	57, 326-327
BEVERAGE TUBS.....	274-277, 350-353
BILL/CHECK PRESENTERS.....	298-301
BISCUIT CUTTERS.....	377
BITTERS BOTTLES.....	329
BOTTLE OPENERS.....	338, 343-344, 358
BOTTLE STOPPERS.....	357
BOWLS.....	12-15, 19, 22-23, 25, 27, 31, 33 35, 38-40, 70-71, 122, 124, 181-184, 188-195, 198, 200, 202, 204, 206-207, 210, 212, 214, 218, 227, 238-239, 242, 245-247, 368
BRUSHES.....	374-375, 437
BUBBLE POPPERS.....	421
BUFFETWARE.....	174-179
BURGER MOLD.....	374
BUTTER WARMERS.....	149

C

CADDIES.....	95, 112, 134-135, 141, 356, 411
CAKE PANS/RINGS.....	377-379

CAKE STANDS & COVER.....	147
CALL BELL.....	380
CAR PANS.....	389
CARAFES.....	96, 98, 331
CARD SIGNS, CARDS & HOLDERS.....	280-290
CAST IRON.....	50-51, 168-169
CEDAR PLANKS.....	368
CHAFERS.....	156, 158-161
CHALK MARKERS & STENCILS.....	296-297
CHALKBOARD CARDS, PAINT & STICKERS.....	289, 289-293, 303
CHAMPAGNE SERVICE.....	346-349
CHECK SPINDLES.....	380
CHEESE GRATERS.....	367, 418
CHEESE PAPER.....	65
CHEMISTRY COLLECTION.....	330
CHINA CAP STRAINERS.....	367
COCKTAIL SHAKERS.....	326, 334-335
COFFEE CADDIES.....	112, 114
COFFEE URNS.....	157-158, 173
COFFEE/TEA SERVICE.....	103-112
CONDIMENT HOLDERS.....	355
CONDIMENT RACKS.....	92-95
CORKSCREWS.....	344
CRATES.....	162, 233, 265, 271-273
CTP PANS.....	391
CULINARY BASKETS.....	373
CUTTERS, BISCUIT & DOUGHNUT.....	377

D

DECALS & LABELS.....	313
DEEP DISH PANS.....	379, 392-398, 400-401
DEEP SELF-STACKING PANS.....	398
DELIVERY BAGS.....	434-436
DETROIT-STYLE PANS.....	401
DINNERWARE.....	10-40
DISHERS.....	364
DOCKERS.....	406-407
DOMES.....	203
DOUBLE-WALL DRINKING VESSELS.....	322-323
DOUGH CUTTERS & SCRAPERS.....	369, 405
DOUGHNUT CUTTER.....	377
DREDGE.....	367
DRINKWARE.....	316-317
DRIP TRAYS.....	157, 173

E

EGG RINGS & SLICER.....	375
ENAMELWARE.....	66

F

FLAME GUARDS.....	166
FLIGHT BOARDS.....	325
FOLDING BEVERAGE FRAMES.....	162
FRENCH FRY SCOOPS.....	368
FRY CUPS.....	58-62
FRY PANS.....	46, 50, 169, 362
FRY PAPER.....	64
FUNNELS.....	360, 374

G

GALVANIZED.....	36, 62, 66, 68, 95, 110, 171, 276, 353
GLASS.....	55-57, 96, 130-136, 144-145, 189, 324-325, 329-331, 335, 409-412
GLASS RACKS.....	360
GRAVY BOATS.....	128-129
GRIDDLES.....	164-168

I

ICE BUCKETS.....	354
ICE CREAM SPADES.....	364
ICE MOLDS.....	333
ICE PICKS.....	342

J

JIGGERS.....	336, 340
JUICE DISPENSERS, BASES & ACCESSORIES.....	157, 170-173

K

KNIVES.....	51, 178-179, 342
-------------	------------------

L

LADLES.....	174, 176-179, 363
LEMON LIME PEELER.....	342
LOBSTER/NUT CRACKERS.....	147
LONG PANS.....	401

M

MALT CUP	335
MARGARITA RIMMER	358
MARKERS	296-297
MEASURED POURERS	357
MEASURING CUPS & SPOONS	366-367
MEGA SCREENS, DISKS & PANS	387
MELAMINE	10-13, 18-35, 37, 40, 44, 52-53, 124, 124-127, 191-222, 417
MENU HOLDERS	298-300
MINI COOKWARE	45-47
MINT JULEP CUPS	61, 324
MIXING BOWLS	376
MIXING GLASSES	328-329, 335
MOROCCAN TUMBLER	322
MOSCOW MULE MUG	318-320
MUDDLERS	338-339
MUGS	13, 23, 25, 30, 66

N

NOODLE BOWLS	23, 40
NUMBER TENTS	280, 408

O

OIL & VINEGAR CRUETS	144
OLIVE WOOD	230-233, 287, 429
OVERFLOW PIPES	360

P

PAILS & TUBS	62-63, 68
PAN GRIPPERS	408
PANS	67, 378-379, 389-401
PAPER	64-65, 413
PAPER TOWEL HOLDERS	146-147
PARTY TUBS	353
PEEL RACK	425
PEELS	423-429
PEPPER MILLS	142-143
PERFORATED DISCS	388-389
PIE PANS	67, 379
PIE ROLLERS	405
PITCHERS	96-103
PIZZA CUTTERS	419

PIZZA CUTTING MATS	421
PIZZA DELIVERY BAGS	434, 436
PIZZA KNIVES, ROCKERS	420
PIZZA PANS & TRAYS	389-401, 417
PIZZA RACKS	422
PIZZA SCREENS	386-387
PIZZA SERVERS	371, 418
PIZZA STANDS	413-416
PIZZA STONES	402-403
PLASTIC DRINKWARE	57, 316-317, 326-327
PLATE COVERS	151-154
PLATES	10-35, 37, 124, 185-186, 196, 203, 417
PLATTERS	12-13, 19, 22, 25, 27, 30, 33, 35, 38-39, 49, 181, 185, 188-190, 195-199, 205, 210-214, 222, 226
POPLAR WOOD	72, 114
PORCELAIN	104, 116-118, 128, 138, 183-187
PROTECTIVE BARRIERS	314
PUNCH BOWLS	353

R

RAMEKINS	116-127
RISERS	252-271
ROLLING PINS	405

S

SAFETY SEALS	313
SALT & PEPPER SHAKERS	135-143
SANITIZER DISPENSERS	55, 145
SAUCE CUPS	116-127, 182-185
SCOOPS	342, 368
SCRAPERS	369, 405
SEAFOOD TRAYS/STANDS	248-251
SEPARATORS	399-400
SERVING BOARDS & PEELS	210-222, 224-237
SERVING BOWLS & LIDS	38-39
SHAKERS	130-143, 409-412
SHERBET DISHES	148
SICILIAN-STYLE PANS	401
SKIMMERS	373
SLIP-STOP SLEEVES	414, 255
SMOKER POLES	305
SOUP CANS	60, 62, 94, 415
SPOONERS	365

SPOONS	174-179, 341-342, 365
SPREADER	175, 380
SPRINGFORM PAN	376
SQUARE DEEP DISH PANS	400
SQUEEZERS	343
STAINLESS STEEL DRINKING VESSELS	318-320 322-324,
STAINLESS STEEL STRAWS	321
STANDS	150, 164-167, 186, 251-270, 348-349, 414-416
STEAK WEIGHTS	374
STORAGE CRATE	161
STRAIGHT-SIDED PANS	396-398
STRAINER FUNNELS	360
STRAINERS	372
STRAW DISPENSER	147
SYRUP DISPENSER	134

T

TABLETOP BOARDS	293-295
TACO HOLDERS	42-44
TAPERED NESTING PANS	392-395
TICKET RACKS	381
TONGS	113, 174, 176-179, 336-337, 372
TRAYS	17, 37-39, 163, 185, 198, 201, 208-209, 226, 240-244, 248-250, 274-275, 292, 345, 350-351, 417
TRIVETS	51, 169
TUBS	68, 274-277, 350-353
TURNERS	370-371
TWEEZERS	341

V

VASES	106-107, 129
-------------	--------------

W

WALL BOARDS	302-303
WARMING STONES	73
WATER BOTTLES	96-98, 331-332
WHIPS	363
WINE BUCKET AND STANDS	346-349
WINE COOLERS	345-347, 349
WOOD OIL	428



3708 River Road, Suite 800
Franklin Park, IL 60131

Phone **708-345-1177**
Fax **708-345-5758**
Toll Free **800-333-9133**
Toll Free Fax **800-333-6046**
Email info@amnow.com
www.amnow.com

© 2022 American Metalcraft, Inc.



**TO VIEW THE LATEST AND
GREATEST PRODUCTS,
SCAN THE CODE BELOW:**

